

TECHNICAL MANUAL

**OPERATOR'S AND ORGANIZATIONAL
MAINTENANCE MANUAL**

**RADIO SET AN/FRC-93(V)1 (NSN 5820-01-054-9106)
RADIO SET AN/FRC-93(V)2 (NSN 5820-01-052-1438)
RADIO SET AN/FRC-93(V)3 (NSN 5820-01-052-1439)
RADIO SET AN/FRC-93(V)4 (NSN 5820-01-053-5535)
RADIO SET AN/FRC-93(V)5 (NSN 5820-01-052-1440)
RADIO SET AN/FRC-93(V)6 (NSN 5820-01-052-1441)
RADIO SET AN/FRC-93(V)7 (NSN 5820-01-052-1442)**

This copy is a reprint which includes current pages from Changes 1 through 6. The title was changed by Change 3.

HEADQUARTERS, DEPARTMENT OF THE ARMY

JUNE 1976

WARNING

Be careful when working on the 275- and 800-volt d.c. terminals of the power supplies, and the 110- or 220-volt a.c. line terminals. Serious injury or death can result from contact with these terminals.

DON'T TAKE CHANCES!

DO NOT BLOCK INTERLOCK SWITCHES

Dangerous voltages are present in this equipment. The high voltage is interlocked with the amplifier covers. NEVER put the amplifier into service until all compartment covers are in place.

Operator and maintenance personnel should be familiar with the requirements of TB SIG 291 before attempting installation or operation of the equipment covered in this manual. Failure to follow the requirements of TB SIG 291 can result in injury or death.

CHANGE

NO.6

Operator's and Organizational Maintenance Manual

RADIO SET AN/FRC-93(V)1 (NSN 5820-01-054-9106)

RADIO SET AN/FRC-93(V)2 (NSN 5820-01-052-1438)

RADIO SET AN/FRC-93(V)3 (NSN 5820-01-052-1439)

RADIO SET AN/FRC-93(V)4 (NSN 5820-01-053-5535)

RADIO SET AN/FRC-93(V)5 (NSN 5820-01-052-1440)

RADIO SET AN/FRC-93(V)6 (NSN 5820-01-052-1441)

RADIO SET AN/FRC-93(V)7 (NSN 5820-01-052-1442)

TM 11-5820-554-12, 18 June 1976, is changed as follows:

1. Remove old pages and insert new pages as indicated below. New or changed material is indicated by a vertical bar in the margin. Where an entire chapter, section, or illustration is added or revised, the vertical bar is placed opposite the identification number and title.

<i>Remove pages</i>	<i>Insert pages</i>
i and ii	i and ii
1-1 and 1-2.....	1-1 and 1-2
3-15 through 3-18.....	3-15 through 3-19
4-1 and 4-2.....	4-1 and 4-2
5-1, 5-2 and 5-3.....	5-1 and 5-2
6-1, 6-2 and 6-3/(6-4 blank)	6-1, 6-2 and 6-3/(6-4 blank)
7-11 and 7-12.....	7-11 and 7-12
8-5 and 8-6.....	8-5 and 8-6
9-3 through 9-6	9-3 through 9-6
10-9 and 10-10.....	10-9 and 10-10
11-7/(11-8 blank).....	11-7/(11-8 blank)
12-3 and 12-4.....	12-3 and 12-4
	13-4.1/(13-4.2 blank)
A-1	A-1

3. File this change sheet in front of the publication.

By Order of the Secretary of the Army:

E. C. MEYER
General, United States Army
Chief of Staff

Official:

ROBERT M. JOYCE
Brigadier General, United States Army
The Adjutant General

DISTRIBUTION:

To be distributed in accordance with DA Form 12-50, Operator's maintenance requirements for AN/FRC-93.

CHANGE

NO.5

Operator's and Organizational Maintenance Manual

RADIO SET AN/FRC-93(V)1 (NSN 5820-01-054-9106)

RADIO SET AN/FRC-93(V)2 (NSN 5820-01-052-1438)

RADIO SET AN/FRC-93(V)3 (NSN 5820-01-052-1439)

RADIO SET AN/FRC-93(V)4 (NSN 5820-01-053-5535)

RADIO SET AN/FRC-93(V)5 (NSN 5820-01-052-1440)

RADIO SET AN/FRC-93(V)6 (NSN 5820-01-052-1441)

RADIO SET AN/FRC-93(V)7 (NSN 5820-01-052-1442)

TM 11-5820-55-12, 18 June 1976, is changed as follows:

1. A vertical bar appears opposite changed material.
2. Remove and insert pages as indicated in the page list below:

<i>Remove</i>	<i>Insert</i>
2-1 and 2-2	2-1 and 2-2
3-5 and 3-6	3-5 and 3-6
5-1 and 5-2	5-1 and 5-2

3. File this change sheet in front of the manual for reference purposes.

By Order of the Secretary of the Army:

E. C. MEYER
General, United States Army
Chief of Staff

Official:

ROBERT M. JOYCE
Brigadier General, United States Army
The Adjutant General

DISTRIBUTION:

To be distributed in accordance with DA Form 12-50, Operator maintenance requirements for AN/FRC-93.

Information in this manual has been furnished by the Collins Radio Company, the Sola Electric Company, the Superior Electric Company, and the Barker and Williamson Company, and shall not be either released outside the government or used, duplicated or disclosed in whole or in part for manufacture or procurement, without the written permission of the above companies.

***TM 11-5820-554-12**

TECHNICAL MANUAL

HEADQUARTERS
DEPARTMENT OF THE ARMY
WASHINGTON, DC, 18 June 1976

NO.11-5820-554-12

OPERATOR'S AND ORGANIZATIONAL MAINTENANCE MANUAL

RADIO SET AN/FRC-93(V)1 (NSN 5820-01-054-9106)

RADIO SET AN/FRC-93(V)2 (NSN 5820-01-052-1438)

RADIO SET AN/FRC-93(V)3 (NSN 5820-01-052-1439)

RADIO SET AN/FRC-93(V)4 (NSN 5820-01-053-5535)

RADIO SET AN/FRC-93(V)5 (NSN 5820-01-052-1440)

RADIO SET AN/FRC-93(V)6 (NSN 5820-01-052-1441)

RADIO SET AN/FRC-93(V)7 (NSN 5820-01-052-1442)

This technical manual is an authentication of the manufacturer's commercial literature and does not conform with the format and content specified in AR 310-3. This technical manual does, however, contain available information that is essential to the operation and maintenance of the equipment.

REPORTING ERRORS AND RECOMMENDING IMPROVEMENTS

You can help improve this manual. If you find any mistakes or if you know of a way to improve the procedures, please let us know. Mail your letter or DA Form 2028 (Recommended Changes to Publications and Blank Forms) direct to: Commander, US Army Communications-Electronics Command and Fort Monmouth, ATTN: DRSEL-ME-MP, Fort Monmouth, NJ 07703. In either case, a reply will be furnished direct to you.

	Paragraph	Page
CHAPTER 1. INTRODUCTION.....	1-1, 1-13	1-1, 1-2
2. RADIO SET AN/FRC-93 CONFIGURATIONS.....	2-1, 2-6	2-1, 2-3
3. RECEIVER TRANSMITTER RH-718/FRC-93		
SECTION I. Introduction.....	3-1, 3-5	3-1, 3-2.1
II. Installation.....	3-6, 3-8	3-2, 3-6
III. Operation.....	3-9, 3-13	3-6, 3-11
IV. Circuit functioning.....	3-14, 3-18	3-15, 3-16
V. Operator's maintenance instructions.....	3-19, 3-24	3-16, 3-17
VI. Organizational maintenance instructions.....	3-25, 3-30	3-18, 3-19
CHAPTER 4. CRYSTAL UNIT SET, QUARTZ CK-31/FRC.....	4-1, 4-4	4-1, 4-2
5. Q-MULTIPLIER/NOTCH FILTER		
SECTION I. Introduction.....	5-1, 5-2	5-1
II. Operation.....	5-3, 5-5	5-1, 5-2
III. Operator's maintenance instructions.....	5-6, 5-7	5-2
IV. Deleted.....	5-8, 5-9	5-2

This manual supersedes TM 11-5820-554-15, 15 July 1965, and so much of TM 11-5820-529-14, 21 March 1975; TM 11-5820532-15, 28 January 1965; TM 11-5820-530-15, 25 June 1964; and TM 11-6110-242-15, 26 June 1967, as pertains to operator and organizational maintenance.

	Paragraph	Page
CHAPTER 6. FILTER, RADIO INTERFERENCE F-1139/GRC-159(V)	6-1, 6-9	6-1, 6-2
7. POWER SUPPLIES		
SECTION I. Power Supply PP-3990/FRC-93	7-1, 7-6	7-1, 7-4
II. Power Supply PP-4151/FRC-93	7-7, 7-12	7-5, 7-6
III. Power Supply PP-4765/GRC-159(V)	7-13, 7-18	7-7, 7-8
IV. Power Supply 12-volt d.c. input	7-19, 7-25	7-8, 7-10
V. Operator's maintenance instructions	7-26, 7-27	7-11
VI. Organizational maintenance instructions	7-28, 7-29	7-11, 7-12
CHAPTER 8. REGULATOR, VOLTAGE CN-1146/FRC-93		
SECTION I. Introduction	8-1, 8-4	8-1
II. Installation	8-5, 8-6	8-4
III. Principles of operation	8-7, 8-15	8-5, 8-6
IV. Operator's maintenance instructions	8-16, 8-17	8-6
V. Organizational maintenance instructions	8-18, 8-19	8-6
CHAPTER 9. REGULATOR, VOLTAGE CN-1214/G		
SECTION I. Introduction	9-1, 9-4	9-1
II. Installation	9-5, 9-7	9-2
III. Operation	9-8, 9-9	9-4
IV. Operator's maintenance instructions	9-10, 9-11	9-4
V. Organizational maintenance instructions	9-12, 9-15	9-4, 9-5
VI. Troubleshooting	9-16, 9-18	9-5, 9-6
CHAPTER 10. CONTROL, RADIO SET C-6118/FRC-93 AND CONTROL, RADIO SET C-7515/FRC-93		
SECTION I. Introduction	10-1, 10-3	10-1, 10-3
II. Installation	10-4, 10-5	10-3
III. Operation	10-6-10-9	10-6, 10-7
IV. Operator's maintenance instructions	10-10, 10-11	10-9
V. Organizational maintenance instructions	10-12, 10-13	10-10
CHAPTER 11. AMPLIFIER RF AM-3979/FRC-93		
SECTION I. Introduction	11-1, 11-3	11-1
II. Installation	11-4, 11-9	11-1, 11-2
III. Operation	11-10, 11-11	11-5, 11-6
IV. Operator's maintenance instructions	11-12, 11-13	11-7
V. Organizational maintenance instructions	11-14, 11-15	11-7
CHAPTER 12. COUPLER, ANTENNA CU-2004/U	12-1, 12-8	12-1
13. ANTENNA, TRANSPORTABLE		
SECTION I. Introduction	13-1, 13-3	13-1, 13-2
II. Installation	13-4, 13-6	13-2, 13-4
III. Operation	13-7, 13-8	13-4
IV. Operating principles	13-9, 13-11	13-4
V. Maintenance	13-12, 13-14	13-4, 13-6
CHAPTER 14. MISCELLANEOUS EQUIPMENT	14-1, 14-8	14-1, 14-2
APPENDIX A. REFERENCES	A-1	
B. BASIC ISSUE ITEMS LIST (BIIL) AND ITEMS TROOP INSTALLED OR AUTHORIZED LIST (ITIAL) (Not applicable)		
C. MAINTENANCE ALLOCATION		
SECTION I. Introduction	C-1	
II. Maintenance allocation chart for Radio Set AN/FRC-931V	C-3	
III. Maintenance allocation chart for Amplifier, RF AM-3979/FRC-93	C-4	
IV. Maintenance allocation chart for Control, Radio Set C-6118/FRC-93	C-5	
V. Maintenance allocation chart for Control, Radio Set C-7515/FRC-93	C-6	
VI. Maintenance allocation chart for Power Supply PP-3990/FRC-93	C-7	
VII. Maintenance allocation chart for Power Supply PP-4151/FRC-93	C-8	
VIII. Maintenance allocation chart for Power Supply, Collins model MP-1	C-9	
IX. Maintenance allocation chart for Power Supply PP-4765/GRC-159(V)	C-10	

TM 11-5820-554-12

Page

SECTION X. Maintenance allocation chart for Receiver-Transmitter, Radio RT-718/ FRC-93.....	C-11
XI. Maintenance allocation chart for Q-multiplier/notch filter (Waters 340A).....	C-12
XII. Maintenance allocation chart for Regulator, Voltage CN-1146/FRC-93.....	C-13
XIII. Maintenance allocation chart for Regulator, Voltage CN-1214/G.....	C-14
XIV. Maintenance allocation chart for Coupler, Antenna CU-2004/U.....	C-15
XV. Maintenance allocation chart for Noise Blanker F-1139/GRC-159.....	C-16
XVI. Maintenance allocation chart for Crystal Unit Set Quartz CK-31/FRC- 93.....	C-17
XVII. Maintenance allocation chart for antenna transportable (Collins 637T-2).....	C-18
INDEX	Index 1

LIST OF ILLUSTRATIONS

<i>Figure</i>	<i>Title</i>	<i>Page</i>
3-1	Fixed Station (100-Watt) Interconnections.....	3-3
3-2	Traveling Station (1,000-Watt) Interconnections.....	3-4
3-3	Mobile Station Interconnections	3-5
3-4	Operating Controls	3-8
3-5	Logging Scale Calibration Curves.....	3-9
3-6	Crystal Socket Locations	3-11
4-1	Crystal Packet, Folded	4-1
4-2	Crystal Packet, Unfolded.....	4-2
4-3	Method of Holding Crystal.....	4-3
6-1	Suggested Connections for Using Broadcast Whip for Both Broadcast Receiver and Noise Blanker.....	6-1
6-2	Noise Blanker, Block Diagram	6-3
7-1	PP-3990/FRC-93 Packed in (Collins CC-2) Carrying Case.....	7-1
7-2	Hardware Installation Diagram.....	7-2
7-3	Installation of Chassis Nuts	7-3
7-4	Phone Jack Assembly During Assembly.....	7-4
7-5	PP-3990/FRC-93 Assembled to Collins KWM-2/2A.....	7-5
7-6	Power Supply PP-4151/FRC-93, Location of Power Plugs PI and P2.....	7-6
7-7	Interconnections to Collins KWM-2/2A.....	7-7
7-8	Collins MP-1, Collins KWM-2/2A, and Collins 351D-2, Mobile Interconnection Diagram.....	7-10
7-9	Mobile Power Supply (Collins MP-1).....	7-11
8-1	Regulator, Voltage CN-1146/FRC-93, Front View (Inclosed).....	8-2
8-2	Regulator, Voltage CN-1146/FRC-93, Front View (Cover Removed).....	8-3
8-3	Control Circuit Board (Removed and Open to Show Detail)	8-4
8-4	Regulator, Voltage CN-1146/FRC-93, Block Diagram	8-5
9-1	Regulator, Voltage CN-1214/G, Front Panel View.....	9-2
9-2	Regulator, Voltage CN-1214/G, Installation	9-3
9-3	Regulator, Voltage CN-1214/G, Operating Controls	9-3
10-1	Collins 312B-4 and Collins 312B-5 Station Controls, Front Panel View, Operating Controls	10-1
10-2	Collins 312B-5, External Connections	10-2
10-3	Interconnections, Collins 312B-5 with Collins KWM-2/2A.....	10-4
10-4	Interconnections, Collins 312B-4 with Collins KWM-2/2A.....	10-5
10-5	Wattmeter Interconnections	10-6
10-6	Vswr Graph for Forward Versus Reflected Power.....	10-8
11-1	Connector Assembly Instructions.....	11-3
11-2	Interconnections With Collins KWM-2/2A Portable (Traveling) Station	11-4
11-3	Fixed or Mobile Station Interconnections.....	11-5
11-4	Collins 30L-1, Operating Controls.....	11-6
12-1	Coupler, Antenna CU-2004/U and Collins 350D-3 Shockmount	12-1
12-2	CU-2004/U and Collins KWM-2/2A, Hookup Diagram	12-2
12-3	Antenna Coupler CU-2004/U, Schematic Diagram	12-4
13-1	Transportable Antenna (Collins 637T-2)	13-1
13-2	Antenna Supported at Housing	13-1
13-3	Frequency Versus Per Side Wire Length.....	13-5
13-4	Collins 637T-2, Schematic Diagram	13-5
13-5	Collins 637T-2 Field Intensity Radiation Patterns, Average Ground.....	13-6
14-1	Microphone, Dynamic M-127/FRC-93 (Collins MM-1)	14-1
14-2	Collins MM-2 Microphone Headset.....	14-1
14-3	Power Cable, Collins 440E-1.....	14-1
14-4	Case, Electrical Equipment CY-6197/GRC-159.....	14-2
14-5	Collins KWM-2/2A and PP-3990/FRC-93 Packed in CY-6197/GRC-159.....	14-3
14-6	Collins CC-3 Packed With Collins 312B-5 and PP-4765/GRC-159	14-3
14-7	Collins CC-3 Packed With Collins 312B-5 and Collins MP-1	14-3
FO-1	Receiver-Transmitter RT-718/FRC-93, Block Diagram.....	FO-1
FO-2	Antenna, Transportable, Collins 637T-2, Exploded View	FO-2

CHAPTER 1 INTRODUCTION

1-1. Scope

This manual describes Radio Set AN/FRC-93 and covers its operational and organizational maintenance. Radio Set AN/FRC-93 is a variable configuration comprised of components selected for a particular military situation. This selection is based on available primary input power (either 14 or 28 volts d.c. or 115 or 230 volts a.c.), voltage regulation if an a.c. source is used, power output required, and whether the installation is mobile or fixed. Paragraph 1-7 through 1-13 lists the components which may be selected. Chapter 2 lists the various equipment configurations. Appendix A contains a list of applicable references and appendix C contains the maintenance allocation charts.

1-2. Consolidated Index of Army Publications and Blank Forms

Refer to the latest issue of DA Pam 310-1 to determine whether there are new editions, changes or additional publications pertaining to the equipment.

1-3. Maintenance Forms, Records, and Reports

a. Reports of Maintenance and Unsatisfactory Equipment Department of the Army forms and procedures used for equipment maintenance will be those prescribed by TM 38-750, The Army Maintenance Management System (TAMMS).

b. Report of Packaging and Handling Deficiencies. Fill out and forward SF 364 (Report of Discrepancy (ROD)) as prescribed in AR 735-11-2/DLAR4140.55/NAVMATINST 4355.73/AFR 400-54/MCO4430.3E.

c. Discrepancy in Shipment Report (DISREP) (SF 361). Fill out and forward Discrepancy in Shipment

Report (DISREP) (SF 361) as prescribed in AR 55-38/NAVSUPINST 4610.33B/AFR 75-18/MCO P4610.19C/DLAR 4500.15.

1-3.1 Reporting Equipment Improvement Recommendations (EIR)

If your AN/FRC-93(V) needs improvement, let US know. Send us an EIR. You, the user, are the only one who can tell us what you don't like about your equipment. Let us know why you don't like the design. Put it on an SF 368 (Quality Deficiency Report). Mail it to us at Commander, US Army Communications Electronics Command and Fort Monmouth, ATTN DRSE L-ME-MP, Fort Monmouth, NJ 07703. A reply will be furnished to you.

1-4. Administrative Storage

Administrative storage of electronic equipment is in accordance with paragraph 3-30.

1-5. Destruction of Army Electronics Materiel

Destruction of Army electronics materiel to prevent enemy use shall be as prescribed in TM 750-244-2.

1-6. Description

Radio Set AN/FRC-93 is a versatile communication set. It transmits and receives continuous wave (cw) or single sideband (ssb), and will transmit with a power output of either 100 watts peak envelop power (pep) or 1,000 watts (pep) in the frequency range of 3.4 to 5.0 and 6.5 to 30 MHz. By selection of applicable components, it can operate as a portable station, a fixed station, or a mobile station and can be installed in automobiles, Army vehicles, boats, and airplanes.

TM 11-5820-554-12

**1-7. Items Comprising an Operable Radio
Set AN/FRC-93(V)1 (NSN 582U-01-054-9106)**

NSN	Item	Qty	Dimensions			Weight (lb)
			Height	Depth	Width	
5820-00-082-4080	Receiver Transmitter RT-718/FRC-93 (Collins KMW-2A)	1	7¾	14	14¾	18
5820-00-034-4234	Power Supply PP-3990/FRC-93 110/220-Volt ac input (Collins PM-2)	1	7¾	4	14¾	13½
5820-00-082-4082	Control. Radio Set C 6118/FRC-93 (Collins 312 B-4)	1	7½	11¾	10¾	8½
5820-00-034-4249	Microphone, Dynamic M-127/FRC-93 (Collins MM-1)	1				
5820-00-034-4235	Case, Electrical Equipment CY-6197/GRC-159 (Collins CC-2)	1	9½	21	21½	9½
5955-00-740-0786	Crystal Unit Set, Quartz CK-31/FRC-93 (Collins CP-1)	1				
5985-00-909-1873	Antenna, transportable (Collins 637 T-2)	1	5	4	9	4
5820-00-075-3161	Case, electrical equipment (Collins CC-3)	1	9½	21	21½	10
5995-00-993-9501	Cable, coaxial (p/n 426-6026-00)	2				
5995-00-087-2590	Cable, patch (p/n 426-3027-00)	1				

1-8. Items Comprising an Operable Radio Set AN/FRC-93(V)2. (NSN 5820-01-052-1438)

NSN	Item	Qty	Dimensions			Weight (lb)
			Height	Depth	Width	
5820-00-082-4080	Receiver-Transmitter RT-718/FRC-93 (Collins KWM-2A)	1	7¾	14	14¾	18
5820-00-034-4233	Power Supply 12 volt dc (Collins MP-1)	1	3¾	5¼	11	7½
5820 00-082-4082	.Control, Radio Set C-6118/FRC-93 (Collins 312 B-4)	1	7½	11¾	10¾	8½
5965 00-034-4249	Microphone, Dynamic M-127/FRC-93 (Collins MM-1)	1				
5820-00-034-4235	Case, Electrical Equipment CY-6197/GRC-159 (Collins CC-2)	1	9½	21	21½	9½
5955-00-074-0786	Crystal Unit Set, Quartz CK-31/FRC-93 (Collins CP-1)	1				
5985-00-909-1873	Antenna, transportable (Collins 637 T-2)	1	5	4	9	4
5820-00-075-3161	Case, electrical equipment (Collins CC-3)	1	9½	21	21½	10
5995-00-993-9501	Cable, coaxial (p/n 426-6026-00)	2				
5995-00-034 -4248	Cable, power (Collins 440-E1)	1				

1-9. Items Comprising an Operable Radio Set AN/FRC-93(V)3 (NSN 5820-01-052-1439)

NSN	Item	Qty	Dimensions			Weight (lb)
			Height	Depth	Width	
5820-00-082-4080	Receiver-Transmitter RT-718/FRC-93 (Collins KWM-2A)	1	7¾	14	14¾	18
5820-00-034-4234	Power Supply PP-3990/FRC-93 (Collins PM-2)	1	7¾	4	14¾	13
5820-00-082-4081	Amplifier, Radio Frequency AM-3979/FRC-93 (Collins 30L-1)	1	6 9/16	13¾	14¾	38
5965-00-034-4249	Microphone, Dynamic M-127/FRC-93 (Collins MM-1)	1				
5820-00-034-4235	Case, Electrical Equipment CY-6197/GRC-159 (Collins CC-2)	1	9½	21	21½	9
5955 00-740-0786	Crystal Unit Set, Quartz CK-31/FRC-93 (Collins CP-1)	1				
5820-00-702-2216	Control, Radio Set -7515/FRC-93 (Collins 312B-5)	1	7½	11¾	10¾	8
5985-00-909-1873	Antenna, transportable (Collins 637T-2)	1	5	4	9	4
5820-00-075-3161	Case, electrical equipment (Collins CC-3)	1	9½	21	21½	10
5995-00-901-4336	Cable, coaxial (p/n 426-5076-00)	2				
5995-00-087-2590	Cable, patch (p/n 426-3027-00)	1				
5935-00-904-4050	Adapter Connector UG-27D/U	2				

1-10. Items Comprising an Operable Radio Set AN/FRC-93(V)4 (NSN 5820-01-053-5535)

NSN	Item	Qty	Dimensions			Weight (lb)
			Height	Depth	Width	
5820-00-082-4080	Receiver-Transmitter RT-718/FR-93 (Collins KWM-2A)	1	7¾	14	14¾	18
5820-00-034-4234	Power Supply PP-3990/FR-93 (Collins PM-2)	1	7¾	4	14 3/4	13
5965-00-034-4249	Microphone. Dynamic M-127/FR-93 (Collins MM-1)	1				

TM 11-5820-554-12

NSN	Item	Qty	Dimensions			Weight (lb)
			Height	Depth	Width	
5955-00-740-0786	Crystal Unit Set, Quartz CK 31/FRC-93 (Collins CP-1).....	1				
5820-00-702-2216	Control, Radio Set -7515/FRC-93 (Collins 312B-5).....	1	7½	11¾	10¾	8½
5995-00-993-9501	Cable, coaxial (p/n 426 6026-00)	2				
5995-00-087-2590	Cable, patch (p/n 426-3027-00)	1				
5935-00-904-4050	Adapter Connector UG-27D/U	2				

1-11. Items Comprising an Operable Radio Set AN/FRC-93(V)5 (NSN 5820-01-052-1440)

NSN	Item	Qty	Dimensions			Weight (lb)
			Height	Depth	Width	
5820-00-082-4080	Receiver-Transmitter PT-718/FRC-93 (Collins KWM-2A)	1	7¾	14	14¾	18
5820-00-034-4234	Power Supply PP-3990/FRC-93 (Collins PM-2)	1	7¾	4	14¾	13½
5820-00-082-4081	Amplifier, Radio Frequency AM-3979/FRC-93 (Collins 30L-1)	1	6 9/16	13¾	14¾	38
5965-00-034-4249	Microphone, Dynamic M-127/FRC-93 (Collins MM-1).....	1				
5955-00-740-0786	Crystal Unit Set, Quarts CK-31/FR-93 (Collins CP-1)	1				
5820-00-702-2216	Control, Radio Set C-7515/FRC-93 (Collins 312B-5)	1	7½	11¾	10¾	8½
5995-00-901-4336	Cable, coaxial (p/n 426-5076-00)	2				
5995-00-087-2590	Cable, patch (p/n 42-3027-00).....	1				
5935-00-904-4050	Adapter Connector UG-27D/U	2				

1-12. Items Comprising an Operable Radio Set AN/FRC-93(V)6 (NSN 5820-00-052-1441)

NSN	Item	Qty	Dimensions			Weight (lb)
			Height	Depth	Width	
5820-00-082-4080	Receiver-Transmitter RT-718/FRC-93 (Collins KWM-2A)..	1	7¾	14	14¾	18
5820-00-034-4233	Power supply 12 volt dc (Collins MP-1)	1	3¾	5¼	11	7½
5820-00-082-4082	Control, Radio Set G6118/FRC-93 (Collins 312 B-4)	1	7½	11¾	10¾	8½
5965-00-034 4249	Microphone, Dynamic M-127/FRC-93 (Collins MM-1).....	1				
5955-00-740-0786	Crystal Unit Set, Quartz CK-31/FRC-93 (Collins CP-1)	1				
5995-00-993-9501	Cable, coaxial (pin 426-6026-00)	2				
5995-00-087-2590	Cable, patch (pin 426-3027-00)	1				
5820-00 034-4243	Mounting, mobile (pin 522-1726-00, Collins model 351D2)	1				
5820-00-960-8526	Filter, Radio Interference FF-1139/GRC-159(V) (noise blanker)(Collins 136B-2)	1	4 11/16	1 7/8	6 3/8	1¼
5965-00-043-0897	Microphone, headset (Collins MM-2).....	1				

1-13. Items Comprising an Operable Radio Set AN/FRC-93(V)7 (NSN 5820-052-1442)

NSN	Item	Qty	Dimensions			Weight (lb)
			Height	Depth	Width	
5820-00-082-4080	Receiver-Transmitter RT-718/FRC-93 (Collins KWM-2A)..	1	7¾	14	14¾	18
5130-00-926-7805	Power Supply PP-4765/GRC-159(V) 24 volt dc input	1	5¾	7¾	11 3/8	12½
5820-00-082-4082	Control, Radio Set C-6118/FRC-93 (Collins 312 B-4)	1	7½	11¾	10¾	8½
5965-00-034-4249	Microphone, Dynamic M-127/FRC-93 (Collins MM-1).....	1				
5955-00-740-0786	Crystal Unit Set, Quartz CK-31/FRC-93 (Collins CP-1)	1				
5995-00-993-9601	Cable, coaxial (p/n 426-6026-00)	2				
5995-00-087-2590	Cable, patch (p/n 426-3027-00)	1				
5820-00-034-4243	Mounting, mobile (p/n 522-1726-00, Collins model 351D2)	1				
5820-00-960-8526	Filter, Radio Interference F-1139/GRC-159(V) (noise blanker) (Collins 136B-2)	1	4 11/16	1 7/8	6 3/8	1¼
5965-00-043-0897	Microphone, headset (Collins MM-2).....	1				

**CHAPTER 2
RADIO SET AN/FRC-93 CONFIGURATIONS**

2-1. Introduction

The official configurations for Radio Set AN/FRC-93(V)1 through 7 are listed in paragraphs which follow. There are seven configurations grouped into three categories: Transportable, fixed station, and mobile.

2-2. Transportable Category

A 100-watt single-sideband radio station can be carried in two suitcases and installed wherever there is a power source of either 110/120 volts ac or 12 to 24 volts dc. A 1,000-watt single-sideband station is made up of three suitcases. Each filled suitcase weighs between 30 and 40 pounds and may be

transported as common luggage. An antenna unit is provided for this category of configuration only.

2-3. Fixed Station Category

There are two configurations applicable to this category: The 100 watt, and the 1,000 watt output. The antenna system used can be any antenna system which will work in the frequency range of operation and an unbalanced feed line of 50 ohms impedance. There are two accessory ac primary power regulators available to the user should the primary power source prove undependable. Listed below are these two regulators and the components of the doublet antenna system, and the technical manuals which support them.

<i>Item</i>	<i>Qty</i>	<i>References</i>
Regulator, Voltage CN 1146/FRC-93 (For the AN/FRC-93(V)4 configuration)	1	TM 11-5820-554-34-6
Regulator, Voltage CN 1214/G (For the AN/FRC 93(V)5 configuration)	1	TM 11-5820-554-34-7

NOTE

The complete antenna system consists of one doublet and three mast assemblies. See referenced technical manual for antenna installation instructions and cautions.

Mast, AB 155A/U	3	TM 11-5820-610-14
Doublet antenna (Used with AN/TRC-133A)	1	TM 11-5820-610-14

2-4. Mobile Category

There are two configurations applicable to this category: 12-volt dc input primary power, and 24-volt dc input primary power. Rf power output is 100 watts in both configurations. The noise

blanking filter is provided in both mobile configurations. The antennas used may be any type of vehicular whip suitably tuned and loaded for the frequency in use. A typical vehicular whip antenna is as follows:

<i>Item</i>	<i>Qty</i>	<i>Reference</i>
Mast Section MS-116A	3	TM 11-5820-610-14
Mast Section MS-117A	1	
Mast Section MS-118A	1	
Mast Base AB-652/GR	1	
Mast Bracket MP-49	1	

NOTE

The above sections are actually the radiating elements of the antenna, and are called mast sections for purposes of identification. For audio reproduction, the loudspeaker in Control Radio Set -6118/FRC-93 is provided with this configuration. If it is impossible to mount this control unit within the vehicle used PM Loudspeaker LS-1 may be ordered separately and mounted within the vehicle in the locations provided for commercial AM radio loudspeakers. The loudspeaker used is as follows:

<i>NSN</i>	<i>Item</i>	<i>Qty</i>	<i>Reference</i>
5965-00-990-8669	Loudspeaker, PM, 4 ohm (Collins LS-1)	1	TM 11-5S20-554-12

2-5. Accessory Equipment

Certain items of equipment may be used with the various configurations as optional, and are to be requisitioned separately as needed by the using organization to ensure dependable communications.

a. *Antenna Coupler CU-2004/U (Collins 180S-1)*. The radio set transportable or fixed station environment may prove unsatisfactory for the installation of a fully extended antenna. In these circumstances, the transmitter has to be loaded to a physically shorter or (in vertical operation) lower piece of antenna conductor. To ensure safe operation of the transmitter, the following item should be ordered and used as instructed in the referenced publication:

	<i>Item</i>	<i>Qty</i>	<i>Reference</i>
Coupler, Antenna CU-2004/U		1	TM 11-5820-554-34-9

A typical use for the coupler is with an aircraft trailing wire antennas.

b. *Dummy Loads*. Dummy loads are available for testing of the AN/FRC-93 transceivers and the choice of dummy load will depend upon the amount of rf power which has to be dissipated by the dummy load. Recommended dummy loads are as follows:

	<i>Item</i>	<i>Qty</i>	<i>Reference</i>
Dummy Load D-1 (100 watt operation only)		1	TM 11-5820-610-14
Dummy Load DA-412A/U (can be used for 1,000 watt operation for a limited time)		1	TM 11-5820-610-14
Terminal Protective Device (TPD) No. 11053186			
Dummy Load DA-75/U (100 or 1,000 watt operation)		1	TM 11-5820-610-14

'This dummy load is the Collins Model DL-1 which must be used with a 6.3v ac control voltage to operate an internal relay. Remote switching of DL-1 is actuated by the RT-718/FRC.

c. *Multiplier and Notch Filter*. Some of the RT-718/FRG-93 transceivers in use have the Waters Q-Multiplier and Notch filter installed in them. These items are no longer available for installation in the transceivers; however, those transceivers which have them installed will require the maintenance outlined in chapter 5 of this manual.

d. *Terminal Protective Device (TPD)*. The terminal protective device is an accessory designed to protect the Control Radio Set, C-6118/FRC-93 from damage due to high voltage transients such as produced by lightning discharges close to the antenna installation.

	<i>Item</i>	<i>Qty</i>	<i>Reference</i>
Terminal Protective Device (TPD) No. 11053186		1	TM 11-5820-610-14

2-6. Configurations

a. *Radio Set AN/FRC-93(V)1, Transportable 100-Watt, 110/220-Volt Ac Configuration.*

NSN	Item	Qty
5820-00-082-4080	Receiver-Transmitter RT-718/FRC-93 (Collins KWM-2A).....	1
5820-00-034-4234	Power Supply PP-3990/FRC-93 110/220-volt a.c. input (Collins PM-2).....	1
5820-00-082-4082	Control, Radio Set C-6118/FRC-93 (Collins 312 B-4).....	1
5995-00-034-4249	Microphone, Dynamic M-127/FRC-93 (Collins MM-1).....	1
5820-00-034-4235	Case, Electrical Equipment CY-6197/GRC-159 (Collins CC-2).....	1
5955-00-740-0786	Crystal Unit Set, Quartz CK-31/FRC-93 (Collins CP-1).....	1
5985-00-909-1873	Antenna, transportable (Collins 637 T-2).....	1
5820-00-075-3161	Case, electrical equipment (Collins CC-3).....	1
5995-00-993-9501	Cable, coaxial (p/n 426-6026-00).....	2
5995-00-087-2590	Cable, patch (p/n 426-3027-00).....	1

b. *Radio Set AN/FRC-93(V)2, Transportable 100-Watt 14-Volt Dc Configuration.*

NSN	Item	Qty
5820-00-082-4080	Receiver-Transmitter RT-718/FRC-93 (Collins KWM-2A).....	1
5820-00-034-4233	Power supply 12 volt dc (Collins MP-1).....	1
5820-00-082-4082	Control, Radio Set C-6118/FRC-93 (Collins 312 B-4).....	1

TM 11-5820-554-12

NSN	Item	Qty
5965-00-034-4249	Microphone, Dynamic-127/FRC-93 (Collins MM-1)	1
5820-00-034-4235	Case, Electrical Equipment CY-6197/GRC-159 (Collins CC-2).....	1
5955-00-740-0786	Crystal Unit Set, Quartz CK-31/FRC-93 (Collins CP-1)	1
5985-00-909-1873	Antenna, transportable (Collins 637 T-2).....	1
5852-00-075-3161	Clue, electrical equipment (Collins CC-3).....	1
5995-00-993-9501	Cable, coaxial (p/n 426-6026-00)	2
5995-00-034-4248	Cable, power (Collins 440E-1)	1

c. Radio Set AN/FRC-98(V)3, Transportable, 1,000-Watt, 110/200-Volt Ac Configuration..

NSN	Item	Qty
5820-00-082-4080	Receiver-Transmitter RT-718/FRC-93 (Collins KWM-2A).....	1
5820-00-034-4234	Power Supply PP-3990/FR-93 (Collins PM-2).....	1
5820-00-082-4081	Amplifier, Radio Frequency AM-3979/FRC-93 (Collins 30L-1).....	1
5965-00-034-4249	Microphone, Dynamic M-127/FRC-93 (Collins MM-1)	1
5820-00-034-4235	Case, Electrical Equipment CY-6197/GRC-159 (Collins CC-2).....	2
5955-00-740-0786	Crystal Unit, Quartz CK-31/FRC-93 (Collins CP-1)	1
5820-00-702-2216	Control, Radio Set C-7515/FRC-93 (Collins 312B-5)	1
5985-00-909-1873	Antenna, transportable (Collins 637T-2).....	1
5820-00-075-3161	Case, electrical equipment (Collins CC-3).....	1
5995-00-901-4336	Cable, coaxial (p/n 426-5076 -00)	2
5995-00-087-2590	Cable, patch (p/n 426-3027-00).....	1
5935-00-904-4050	Adapter Connector UG-27D/U	2

d Radio Set AN/FRC-93(V)4, Fixed Station, 100-Watt 115-Volt Ac 50/60 Cps Configuration.

NSN	Item	Qty
5820-00-082-4080	Receiver-Transmitter RT-718/FRC-93 (Collins KWM-2A).....	1
5820-00-034-4234	Power Supply PP-3990/FRC-93 (Collins PM-2)	1
5965-00-034-4249	Microphone, Dynamic M-127/FRC-93 (Collins MM-1)	1
5955-00-740-0786	Crystal Unit Set, Quartz CK-31/FRC-93 (Collins CP-1)	1
5820-00 702-2216	Control, Radio Set C-7515/FRC-93 (Collins 312B-5)	1
5995-00-993-9501	Cable, coaxial (p/n 426-6026-00)	2
5995-00-087-2590	Cable, patch (p/n 426-3027-00).....	1
5935-00-904-4050	Adapter Connector U-27D/U	2

e. Radio Set AN/FRC-93(V)5, Fixed Station, 1,000-Watt, 115/230-Volt Ac Configuration.

NSN	Item	Qty
5820-00-082-4080	Receiver-Transmitter RT-718/FRC-93 (Collins KWM-2A).....	1
5820-00-034-4234	Power Supply PP-3990/FRC-93 (Collins PM-2)	1
5820-00-082-4081	Amplifier, Radio Frequency AM-3979/FRC-93 (Collins 30-1).....	1
5965-00-034-4249	Microphone, Dynamic M-127/FRC-93 (Collins MM-1)	1
5955-00-740-0786	Crystal Unit Set, Quartz CK-31/FRC-93 (Collins CP-1)	1
5820-00-702-2216	Control, Radio Set C-7515/FRC-93 (Collins 312B-5)	1
5995-00-901-4336	Cable, coaxial (p/n 426-5076-00)	2
5995-00-087-2590	Cable, patch (p/n 426-3027-00).....	1
5935-00-904-4050	Adapter Connector UG-27D/U	2

f. Radio Set AN/FRC-93(V)6, Mobile, 100-Watt, 14-Volt Dc Configuration.

NSN	Item	Qty
5820-00-082-4080	Receiver-Transmitter RT-718/FRC-93 (Collins KWM-2A).....	1
5820-00-434-4233	Power Supply 12 volt dc (Collins MP-1).....	1
5820-00-082-4082	Control, Radio Set C-6118/FRC-93 (Collins 312 B-4)	1
5965-00-034-4249	Microphone, Dynamic M-127/FRC-93 (Collins MM-1)	1
5955-00-740-0786	Crystal Unit Set, Quartz CK-31/FRC-93 (Collins CP-1)	1
5995-00-740-9501	Cable, coaxial (p/n 426-6026-00)	2
5995-00-087-2590	Cable, patch (p/n 42-3027-00).....	1
5820-00-034-4243	Mounting, mobile (p/n 522-1726-00, Collins Model 351D2).....	1
5820-00-960-8526	Filter, Radio Interference F-1139/GRC-159(V) (noise blanker) (Collins 136B-2).....	1

NSN	Item	Qty
5965-00-043-0897	Microphone, headset (Collins MM-2).....	1.....

g. Radio Set AN/FRC-93(V)7, Mobile 100-Watt 28-Volt Dc Configuration.

NSN	Item	Qty
5820-00-082-4080	Receiver-Transmitter RT-718/FRC-93 (Collins KWM-2A).....	1.....
6130-00-926-7805	Power Supply PP-4766/GRC-159(V) 24 volt dc input (Collins 516E-2)	1.....
5820-00-082-4082	Control, Radio Set C-6118/FRC-93 (Collins 312 B-4)	1.....
5965-00-034-4249	Microphone, Dynamic M-127/FRC-93 (Collins MM-1)	1.....
5955-00-740-0786	Crystal Unit Set, Quartz CK-31/FRC-93 (Collins CP-1)	1.....
5995-00-993-9501	Cable, coaxial (p/n 426-6026-00)	2.....
5995-00-087-2590	Cable, patch (p/n 426-3027-00).....	1.....
5820-00-034-4243	Mounting, mobile (p/n 522-1726- 00, Collins Model 361D2)	1.....
5820-00-960-8526	Filter, Radio Interference F-1139/GRC-159(V) (noise blanker) (Collins 136B-2).....	1.....
5965-00-043-0897	Microphone, headset (Collins MM-2).....	1.....

CHAPTER 3
RECEIVER-TRANSMITTER RT-718/FRC-93

Section I. INTRODUCTION

3-1. General

This chapter describes Receiver-Transmitter RT-718/FRC-93 (Collins KWM-2 and KWM-2A), to be referred to as the transceiver. This chapter covers installation, operation, and operator's and organizational maintenance.

3-2. Description

NOTE

The Model KWM-2A will be supplied for all new procurements; however, a resupply from Depot stocks may include either model.

The Collins KWM-2, and KWM-2A transceivers are capable of covering any frequency within the ranges of 3.4 to 5.0 MHz and 6.5 to 30 MHz, with the crystals furnished. The Collins KWM-2 is equipped with 14 crystal sockets which are selectable from the front panel and provide 14 operating bands, each 200-kHz wide. The Collins KWM-2A differs only in the number of crystal sockets furnished, the method of switching crystals, and slight electrical and mechanical differences related to crystal switching. It is equipped with an extra crystal-mounting board which doubles the number of selectable crystal sockets. Crystals for added coverage may be plugged into spare sockets in either transceiver.

3-3. Requirements for Operation

Either transceiver requires a 110-volt, 50- to 60-Hertz, ac power source and a power supply, such as the PP-3990/FRC-93 or PP-4151/FRC-93, for fixed station operation. It consumes approximately 190 watts of power from the line in receive function and approximately 430 watts in transmit function. The transceiver may be operated as a mobile station by using a Collins MP-1 for 12-volt dc operation or a PP-4765/GRC-159(V) for 24- to 28-volt dc operation. In mobile operation, the transceiver requires 800 volts dc at approximately 175 ma; 275 volts dc at approximately 210 ma, a bias supply adjustable between -60 and -80 volts; and 6-, 12-, or 24-volt dc filament supply at 11.0, 5.5, or 2.75 amperes,

respectively from its primary power supply. Any high-impedance crystal or dynamic microphone may be used. A 4-ohm speaker is required.

NOTE

Any commercial or military 4-ohm voice coil impedance speaker may be used with the equipment. The speaker voice coil should be capable of withstanding peak power of 5 watts for best service.

The antenna and feed system must present a 50-ohm load with answer not exceeding 2.0 to 1 looking into the RF OUTPUT jack.

3-4. Tabulated Data

Frequency range.....	3.4 to 5.0 and 6.5 to 30 mhz.
Mode.....	Single sideband (either sideband selectable) or cw.
Type of service.....	Ssb—continuous;cw—50% duty cycle.
Power consumption from a.c. line.....	190 watts in receive function. 430 watts peak in lock-key. 290 watts in voice transmit.
Plate power input	157 watts pep (nominal) into 50-ohms on 80-, 40-, and 20 meter bands. 90 watts pep (nominal) into 50 ohms, on 15-meter band. 80 watts pep (nominal) into 50 ohms, on 10-meter band.
Audio input	High-impedance microphone or phone patch
RF output impedance.....	50 ohms with not more than 2.0 to 1 swr.
RF input impedance	50 ohms.
RF feedback	Approximately 10 db of RF feedback around pa and driver.
Matching speaker impedance	4 ohms.
Matching phone jack impedance	500 to 1,000 ohms, receive output to phone patch; high-impedance phone jack input to transmitter.
Calibrator	100-hertz crystal oscillator.
Frequency stability	Within 100 hertz during any 1-hour period following 20-minute warm-up. Not more than 100 Hz with ±10% line voltage variation.
Calibration accuracy.....	1 kHz after midband calibration.
Backlash.....	Not more than 50 hertz.
Keying	Break-in cw with sidetone provided.

TM 11-5820-554 12

Audio frequency response	300 to 2,400 Hz \pm 6-dB
Audio compression characteristics	ALC operates on IF band and RF amplifier stages and is capable of 10-dB compression.
Carrier suppression	Carrier 50 dB down from output signal
Unwanted sideband	50 dB down from output signal
Oscillator feed through and/or mixer products (undersized)	50 dB down from output signal (40 dB down at 3,500 kHz)
Second harmonic radiation	40 dB down from output signal.
Third order distortion.....	30 dB down from output signal
Noise level.....	40 dB below single tone carrier

Receiver sensitivity	0.5 microvolt for 10-dB signal-plus-noise ratio in amateur bands.
Receiver selectivity	2.1-kHz bandwidth at 60-dB down, 5-3-kHz bandwidth at 60-dB down.
Receiver spurious response	Image rejection better than 40dB Interval spurious signals below 1 microvolt equivalent antenna input.
Automatic gain control	Audio output level does not change more than 20 dB as the input signal is changed front 10 microvolts to 1 volt. Fast attack and slow release avc action on voice and cw.
Receiver output level	1.0 watt at agc threshold.

3-5. Items Comprising an Operable Receiver-Transmitter RT-718/FRC-93

NSN	Item	Dimensions			Weight		(lb)
		Qty	Height	Depth	Width		
5820-00-566-8373*	Receiver-Transmitter RT-718/FRC-93 (Collins KWM-2)	1	7 $\frac{3}{4}$	14	14 $\frac{3}{4}$	18	18
5820-00-082-4080	Receiver-Transmitter RT-718/FRC-93 (Collins KWM-2A)	1	7 $\frac{3}{4}$	14	14 $\frac{3}{4}$	18	18

*See paragraph 3-2 note.

Section II. INSTALLATION

3-6. Unpacking

Carefully lift the transceiver out of the packing material. Examine for visible damage. If the transceiver has been damaged in shipment, follow the procedures outlined in paragraph 1-3. Check to see that all tubes and crystals are seated properly in their sockets. Check tuning controls and switches for freedom of action.

3-7. Mounting and Cabling

For 100-watt, fixed-station installation, refer to figure 3-1. For mobile installation, refer to figure 3-3. Traveling 1,000-watt station interconnections are shown in figure 3-2.

CAUTION

The Collins KWM-2/2A must be operated into a 50-ohm load with a vswr not exceeding 2.0-1. Random length wire antennas or light bulb dummy loads cannot be used. Conventional half-wave dipoles and beam antennas may be used at, or very near their resonate frequency. Exceeding a vswr of 2.0-1 can destroy the components in the output stage of this transceiver.

a. *Fixed-Station Installation.* Connect associated equipment to the Collins KWM-2 or KWM-2A (fig.3-1). ANT SW connector J25 supplies band information in the form of grounds for each 3.5-, 7-, 14-, 21-, and 28-MHz operating band. This system provides a convenient method of providing band information to automatically tuned antenna systems

for both fixed- and mobile-station use. The Collins KWM-2/2A is set up for a high-impedance phone patch input (at PHONE PATCH input J11) such as the phone patch supplied in Control, Radio Set C-6118/FRC-93 or C-7515/FRC-93. A low-impedance phone patch, (Collins 189A-2), may be used by making the following change in the Collins KWM-2/2A. Disconnect the two brown-white wires from pin F on terminal board E60. Use an ohmmeter to determine which of the two wires is connected to PHONE PATCH jack J11. Connect this wire to pin 7 of V1. Resolder the other brown-white wire as originally connected.

b. *Mobile Installation.* Select a location in the car to install the transceiver. Allow clearance on all sides to assure adequate ventilation. If VOX operation is desired, leave enough space above the transceiver to open the top cover for adjustment of VOX and ANTIVOX GAIN controls, S-meter zero, etc. If the Collins 351D-2 is to be used, drill holes and fasten the adapter bracket to the transmission hump with self-tapping screws. Attach the mount to the bracket. Swing the cantilever supports forward. Install the side slides in the Collins KWM-2/2A according to the Collins 351D-2 installation instructions. Remove the plastic dust covers from the (Collins 351D-2) plugs, and store them in the recesses of the mount. Slide the transceiver onto the mount and push back until

TM 11-5820-554-12

the mount plugs have entered the transceiver sockets. Tighten the wingnuts on the sides of the transceiver. See the Collins 351D-2 instruction sheet for mobile mount installation.

(1) Select a location in the car for mounting the Collins MP-1. This location must be as clean and dry as possible. Location in the luggage compartment under the seat or on the passenger side of the fire wall is satisfactory. DO NOT mount in the engine compartment.

(2) Determine the length of power cable needed (furnished with the Collins 351 D-2) to connect the Collins MP-1 to the Collins KWM-2/ 2A, and cut to the required length. Connect the power supply, speaker, and microphone (fig. -3). The Collins 440E-1 may be used to connect the

power supply to the transceiver when the Collins 351D-2 is not used.

CAUTION

Before making connections to the automobile electrical system, make sure that the primary circuits in the Collins MP-1 are connected for proper ground polarity. Correct connections for either positive or negative ground systems are shown in figure 3-3.

(3) If operation is to be in a boat or plane having a 115-volt 400-Hz power supply, use the PP-4151/FRC-93 with C1 (0.05 μ f) removed from across L1 in the filter circuit. If the operation is to be in a boat or plane having a 24-volt d.c. power

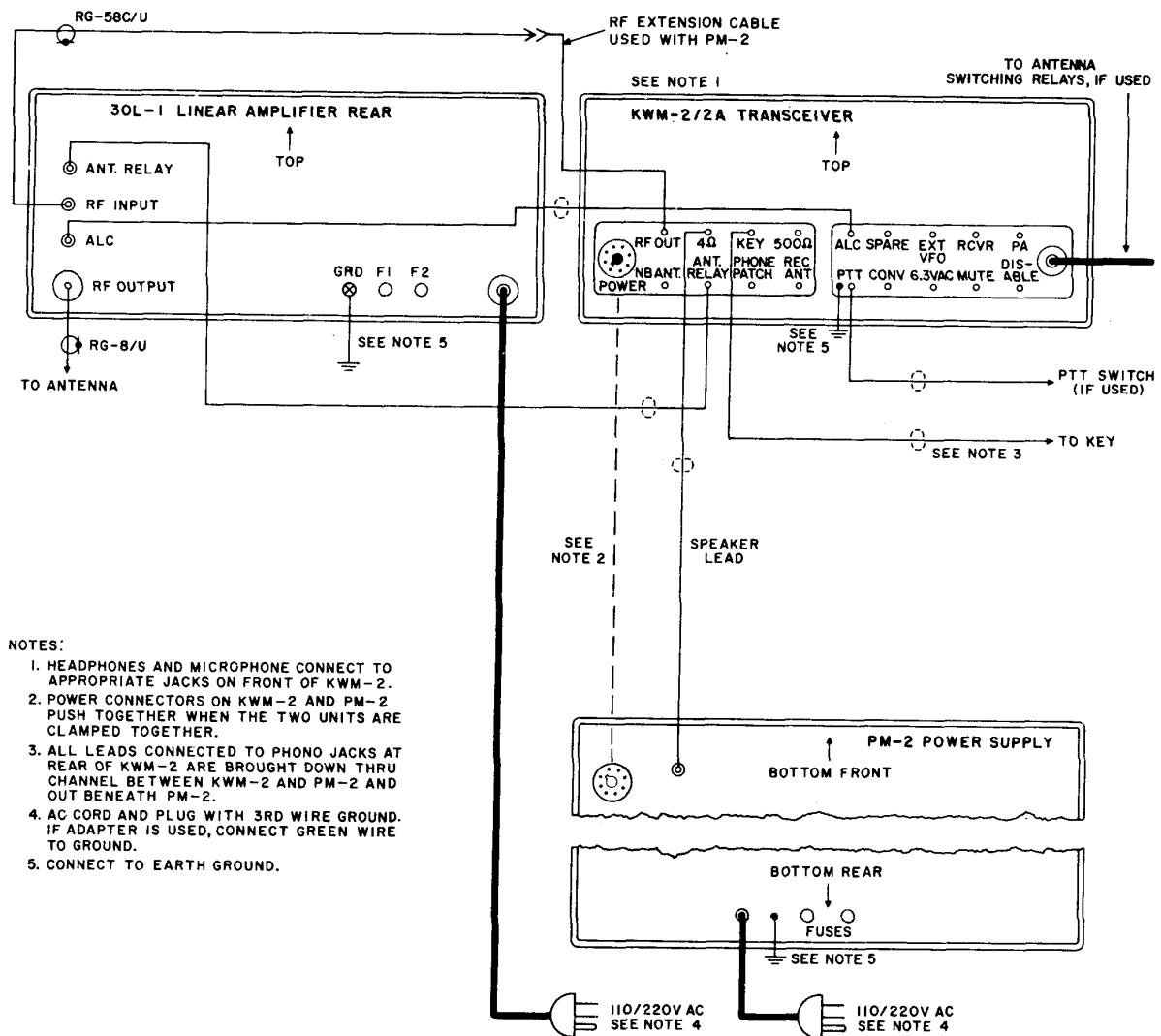

Figure 3-2 Traveling station (1,000-watt) interconnections.

TM 11-5920-554-12

(c) If capacitor bypasses are not satisfactory, remove them, and use chokes in series with the leads from the fields and armature terminals of the generator. Place these chokes as close as possible to the voltage regulator.

(d) For the field lead choke, wind 12 turns of No. 18 wire on a ¼ inch diameter powdered-iron core. For the armature lead, wind 12 turns of No. 14 or larger wire on a 1/4 -inch diameter powdered-iron core.

(e) Ground the rear end of the exhaust pipe to the car body with copper braid, using a radiator hose type clamp to secure the braid to the tail pipe.

WARNING

In the following checks and adjustments here and throughout this manual, do not leave the EMISSION switch in the LOCK position for more than 30 seconds. Damage to the equipment components will result.

3-8. Initial Checks

(fig. 3-4)

Turn the MIC GAIN control (4) fully counterclockwise until the switch clicks. Set the OFF-ON-NB-CAL switch (1) to ON. Set the meter switch (8) to PLATE and the EMISSION switch (2) to LOCK. The transceiver is in receive condition during warm-up, so the meter will read full-scale until the filaments have reached operating temperature. This is normal S-meter action. When the S-meter falls back to zero, the circuits will have switched to transmit condition and the meter will indicate plate current. Read the no-signal plate current. It should be approximately 40-ma. If the plate current is other than 40-ma, adjust the BIAS ADJUST potentiometer on the top rear of the power supply chassis to set the plate current to 40 ma. If the transceiver is to be used with a linear amplifier, set the bias to produce 50-ma idling plate current.

Section III. OPERATION

3-9. Starting Procedure

To turn on the Collins KWM-2/2A, set the OFF-ON-NB-CAL switch (1, fig. 3-4) to ON. This turns on the power source being used with the Collins KWM-2/2A. Allow a 1-minute warm-up period.

CAUTION

Set the MIC GAIN control (4) to OFF and the EMISSION switch (2) to LSB, USB, or CW to prevent accidental transmit condition before warmup or tuning.

3-10. Selecting Collins KWM-2/2A Operating Frequency

CAUTION

The Collins KWM-2/2A must be operated into a 50-ohm load with an swr not to exceed 2.0:1. Random length wire antennas or light bulb dummy loads cannot be used. Conventional half-wave dipoles and beam antennas may be used at, or near, their resonant frequency. Exceeding an swr of 2.0:1 can destroy the components in the output stage of this transceiver.

a. Set the EXCITER TUNING (6) and P.A. TUNING (7) controls to the desired operating frequency. Refer to the logging scale calibration curves in figure 3-5. If the operating frequency is outside an amateur band, ignore the amateur band

markings on the dial scale and set the controls according to figure 3-5.

CAUTION

If the transmitter drive is insufficient or receiver sensitivity is lacking, retune the trimmer capacitors according to paragraph 3-136.

b. Refer to table 3-2 to determine the crystal frequency corresponding to the desired operating frequency and BAND switch (3) position. Insert the appropriate crystal in the crystal board (12) and set the BAND switch to (3) to the proper position for the installed crystal.

NOTE

Be sure to insert the crystal in one of the sockets corresponding to the band in which the crystal belongs. A crystal in band C, for example, should be inserted in socket 1C, 2C, or 3C. Refer to table 3-2 for a list of crystal frequencies and operating bands.

c. Set the variable frequency oscillator (vfo) tuning dial (13) so that the bandswitch setting (crystal band frequency lower limit in MHz) and the vfo tuning dial (13) setting in kHz add to give the desired operating frequency.

TM 11-5820-544-12

NOTE

Before setting the vfo tuning (13), calibrate the vfo by setting the OFF-ON-NB-CAL switch (1) to CAL and zero-beating the calibration signal at the 0, 100, or 200 dial marking, whichever is closest to the desired operating frequency. Adjust the dial hairline so that it is directly over the dial 0, 100, 200 marking at zero beat. Set the OFF-ON-NB-CAL switch (1) to ON.

3-11. Receiver Tuning

(fig. 34)

a. Set the OFF-ON-NB-CAL switch (1, fig. 3-4) to ON (table 3-1).

b. Set the EMISSION switch (2) to the desired side-band (USB or LSB) position. Set the BAND switch (3) to the desired band. On the Collins KWM-2A, set the crystal board selector (12) so that a desired set of bands appears in the window.

c. Set the MIC GAIN control (4) fully counterclockwise. Set the R.F. GAIN control (10) fully clockwise.

d. Set the VOX GAIN control (R39) (under top cover) fully counterclockwise.

e. Set the ANTIVOX GAIN control (R45) (under top cover) fully counterclockwise.

f. Adjust the A.E. GAIN control (5) until some receiver noise is heard in the speaker.

g. Adjust the EXCITER TUNING control (6) to the white portion of the scale indicating the desired band. Rock this control slightly to peak the receiver noise output. The transceiver is now ready to receive and the selected 200-kHz band may be tuned with the tuning control. The operating frequency can be determined by adding the dial reading to the BAND switch (3) setting.

h. Turn the OFF-ON-NB-CAL switch (1) to CAL. Tune the dial to the nearest 100-kHz point (0, 100, or 200), and decrease the R.F. GAIN control (10) as necessary for a comfortable listening level. Adjust the tuning until the calibrate signal is zero beat. When the calibrate signal is zero beat in the receiver, set the hairline on the 100 kHz mark with the zero beat knob (11). Set the OFF-ON-NB-CAL switch (1) to ON and tune the dial to the desired portion of the 200 kHz band selected.

WARNING

During amateur operation. DO NOT operate the transmit circuits while the transceiver is tuned to receive outside the band in use. The transmit frequency is always locked to the receive frequency. Return tuning to within the band before transmitting.

NOTE

The crystal calibrator will also be heard at dial settings 55 and 155 when the OFF-ON-NB-CAL switch (1) is at CAL. Ignore these responses.

CAUTION

Do not keep the Collins KWM-2/2A plate current above 230 ma for longer than 30 seconds at one time. If the operating frequency is changed, recheck turning and loading adjustments. Readjust if necessary.

3-12. Transmitter Tuning

a. General

(1) Set up for receive function as in paragraph 3-10.

(2) Set the EMISSION switch (2) to TUNE.

(3) Set the P.A. TUNING control (7) to the white portion of the dial indicating the desired band (for amateur operation). If the transceiver is being operated outside the amateur bands, ignore the amateur band markings on the dial scale, and set the control according to the logging scale charts (fig. 3-5).

(4) Set the meter switch (8) to PLATE.

(5) Advance the MIC GAIN control (4) fully clockwise, and rock the EXCITER TUNING control (6) until maximum plate current is obtained.

(6) IMMEDIATELY dip the plate current with the P.A. TUNING control (7).

(7) Return the MIC GAIN control (4) fully counterclockwise.

(8) Set the meter switch (8) to GRID.

(9) Advance the MIC GAIN control (4) until grid current is obtained.

(10) Rock the EXCITER TUNING control (6) to obtain a peak in grid current indication.

(11) Turn the MIC GAIN to OFF.

(12) Set the EMISSION switch (2) to LOCK.

(13) Advance the MIC GAIN (4) to provide a grid current reading of approximately 1/3 scale.

(14) Set the meter switch (8) to PLATE.

(15) Alternately dip plate current with the P.A. TUNING Control (7), and adjust loading with the INCR LOAD control (9) until plate current is 230-ma at the dip. When operating the transceiver with a linear amplifier, load to only 200-ma.

(16) Set the EMISSION switch (2) to LSB, USB, or CW.

b. Single-Sideband Operation.

(1) Set up receiver operation and transmitter operation completely as in paragraph 3-11 and *a* above.

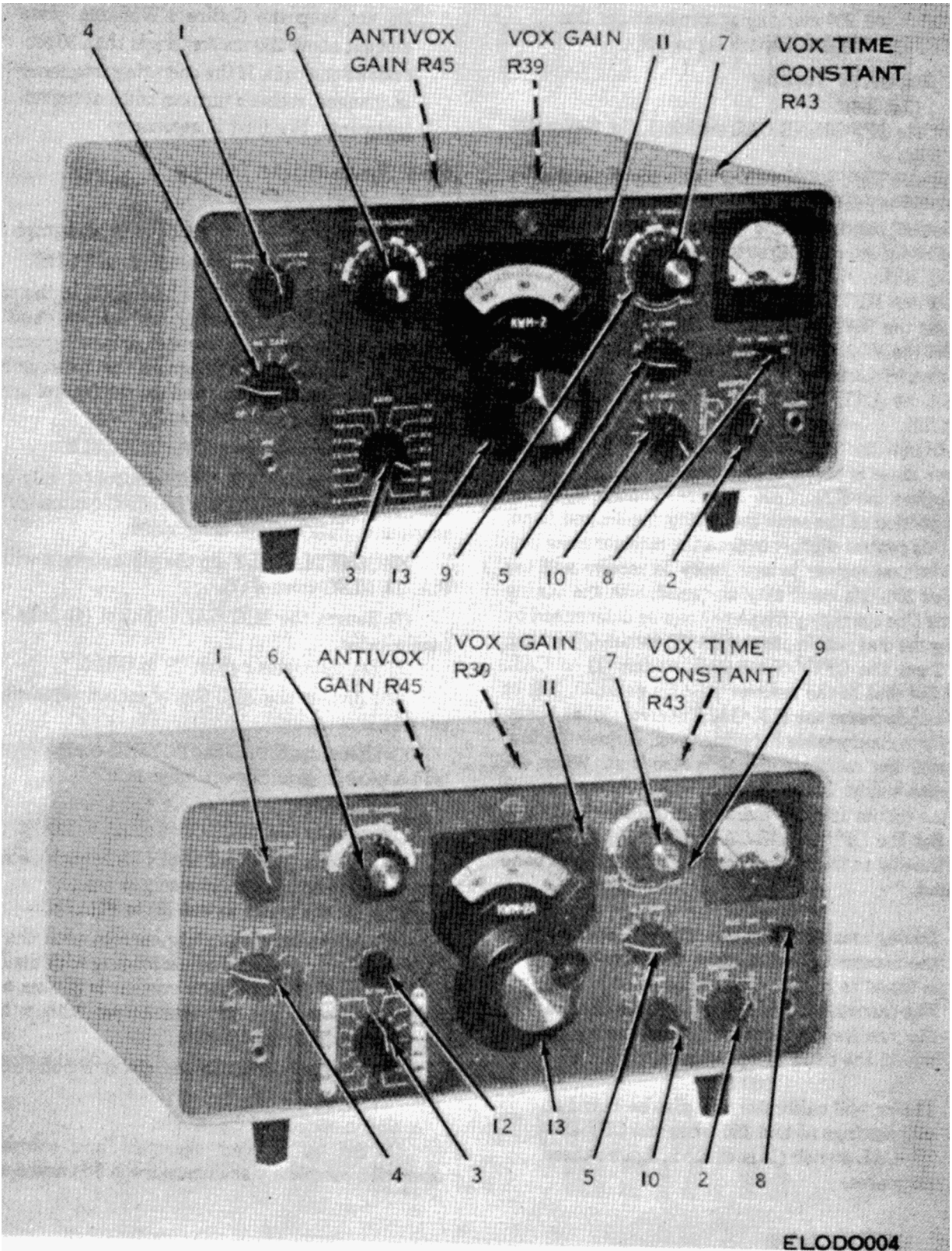
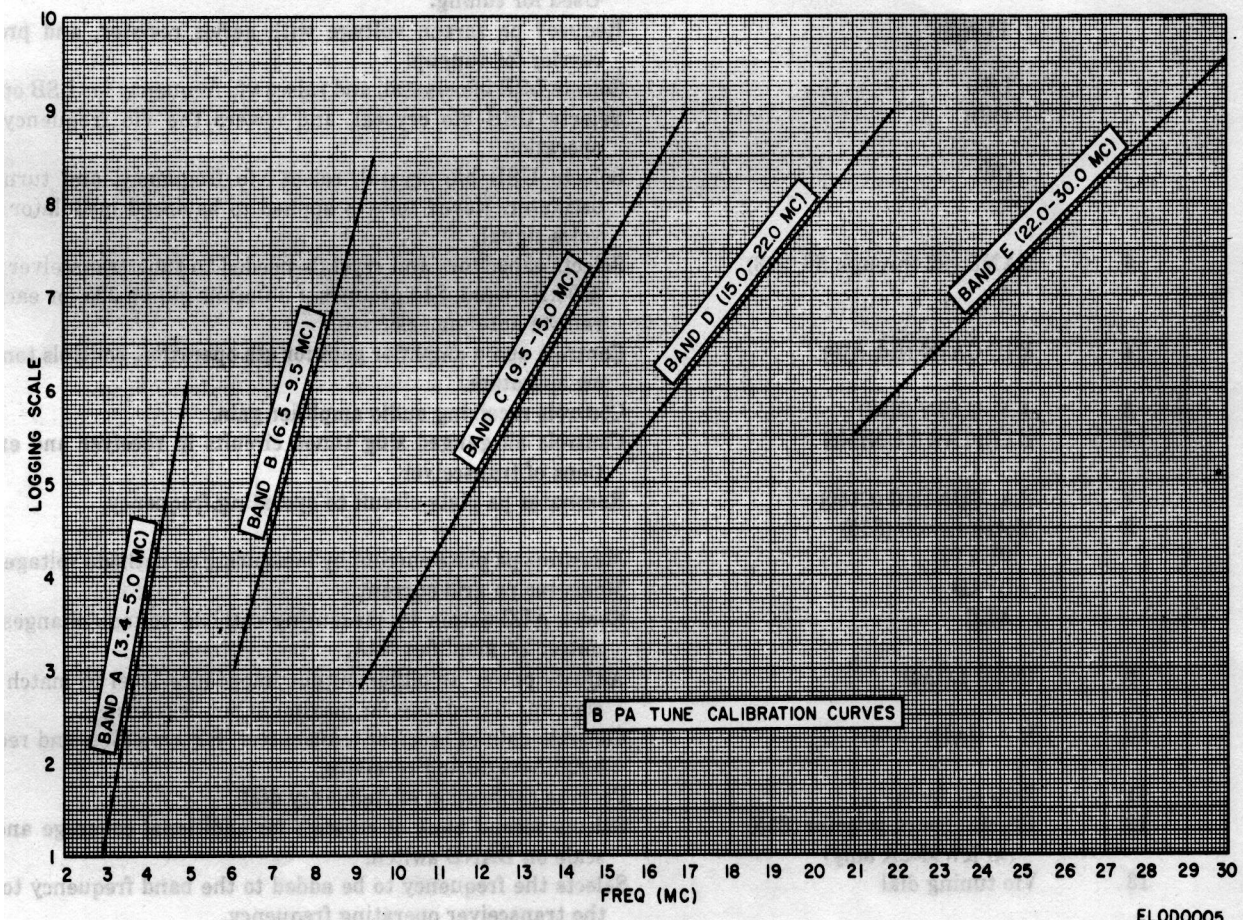
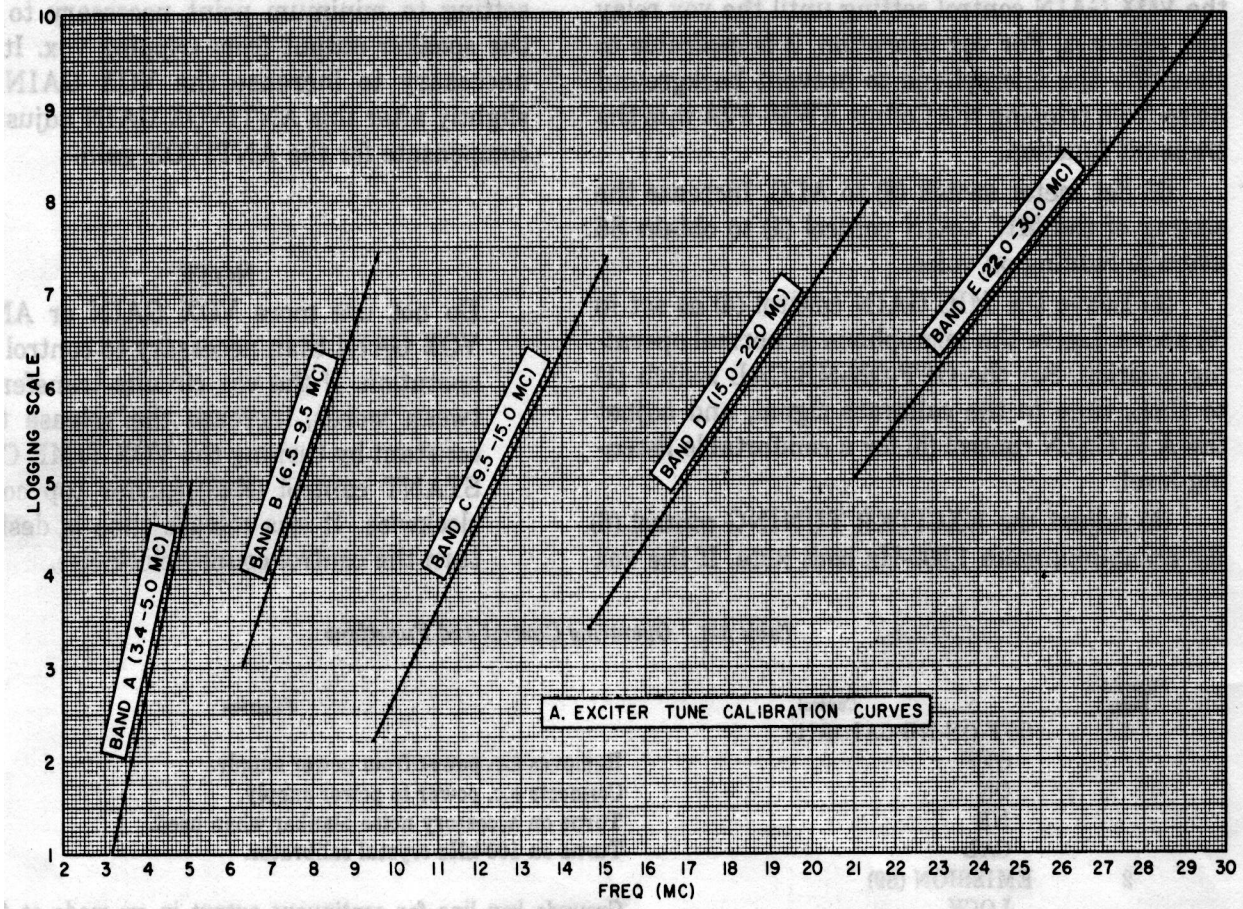

Figure 3-4.
3-8



EL000005

Figure 3-5. Logging scale calibration curves.

(2) Close-talk into the microphone, increasing the VOX GAIN control setting until the vox relay just operates. For vox operation, it is desirable to close-talk the microphone to prevent background noise from tripping the Collins KWM-2/2A into the transmit function.

(3) Set meter switch (8) to ALC. Increase the setting of the MIC GAIN control (4) to obtain S6 average reading on voice.

(4) Leave the MIC GAIN control (4) as set in (3) above. Leave the microphone in normal operating position. Set the OFF-ON-NB-CAL switch (1) to CAL, tune in the calibrate signal, and adjust the A.F. GAIN control

(5) Adjust the EXCITER TUNING control (6) for an approximate 1,00-Hz beat note. If the vox

relay trips, increase the ANTIVOX GAIN (R45) setting to minimum point necessary to prevent the speaker output from tripping vox. It may be necessary to increase the VOX GAIN setting slightly after this ANTIVOX GAIN adjustment to compensate for the ANTIVOX gain.

NOTE

Do not use more VOX GAIN or ANTIVOX GAIN than necessary to control vox operation. If the vox circuits transfer between words, increase the release time constant by turning the VOX TIME CONSTANT control (R43) (under top cover) clockwise. If less release time is desired, turn the control counterclockwise

Table 3-1. Operating Control and Functions

Figure 3-4

Index	Control	Function
1	OFF-ON-NB-CAL-(S11) OFF ON NB CAL	Removes a.c. power from power supply. Connects a.c. power to power supply. Turns on accessory noise blanker when used. Turns on 100-kHz crystal calibrator.
2	EMISSION (S9) LOCK TUNE LSB USB CW	Grounds key line for continuous output in cw mode at full power. Used for tuning. Reduces pa screen voltage with series resistor, and produces cw carrier for tune-up. Selects LSB bfo crystal, and raises vfo frequency for LSB operation. Selects USB bfo crystal, and lowers the vfo frequency for USB operation Selects USB bfo crystal, raises vfo frequency, and turns on tone oscillator. Keyed tone is applied to balanced modulator instead of voice signal. voice signal.
3	BAND (S2 through S8, S13)	Selects capacitors and crystals needed to tune transceiver to desired 200-kHz band. S13 grounds a different pin on J25 for each band for remote antenna selection.
4	MIC GAIN (R8, S10)	Controls audio amplifier gain for ssb operation, controls tone level for cw operation.
5	A.F. GAIN (R92)	Controls receiving audio amplifier gain.
6	EXCITER TUNING	Controls all ganged slug tuned circuits in receiver and exciter portions of transceiver.
7	P.A. TUNING (C150)	Resonates pa plate circuit to operating frequency.
8	Meter switch (S12) PLATE GRID ALC	Measures pa plate current by measuring pa cathode voltage changes. Measures pa grid current. Shows ALC action by measuring cathode voltage changes at transmitter IF amplifier V4A.
9	INCR LOAD	Adjusts power amplifier output impedance level to match transmission line impedance for maximum power transfer.
10	R.F. GAIN (R84)	Controls gain of receiver-transmitter, RF amplifier, and receiving IF amplifiers during receiving.
11	Zero set knob	Permits calibration of frequency dial.
12	Crystal board selector (S15) (in KWM-2A only)	Selects second bank of crystals for additional coverage and changes scale on BAND switch.
13	Vfo tuning dial	Selects the frequency to be added to the band frequency to establish the transceiver operating frequency.
	Inside cabinet VOX GAIN (R39)	Controls gain of vox amplifier for voice-controlled operation.
	Inside cabinet VOX TIME CONSTANT (R43)	Controls held-in time of vox circuit
	Inside cabinet ANTIVOX GAIN (R45)	Controls level of antivox signal fed to vox circuit.

TM 11 - 5820-554-12

(6) Set the OFF-ON-NB-CAL switch (1) to ON. The Collins KWM-2/2A is now ready for transmit operation in ssb service. Speaking into the microphone transfers from receive function to transmit function through the vox circuit action. If the receiver is tuned to a different frequency, the transmitter is also tuned to this new receiver frequency.

(7) After changing frequency, set the EMISSION switch (2) to LOCK and make the following checks:

(a) Set the meter switch (8) to grid.

(b) Adjust the EXCITER TUNING control (6) slightly to check to see that the pa grid drive is peaked. If not, repeat *a*(10) above.

(c) Set the meter switch (8) to PLATE, and check the dip in plate current with the P.A. TUNING control (7).

(d) Set the EMISSION switch (2) back to the desired operating position.

c. Cw Operation.

NOTE

The cw output signal is 1,750 Hz higher than the dial reading. To set the cw output signal frequency, subtract 1,760 Hz from the desired output signal frequency. Set the crystal and vfo dial for the resultant output in cw operation.

(1) Set the OFF-ON-NB-CAL (1) switch to ON.

(2) Set up receiver and transmitter operation according to paragraph 3-11 and *a* above, with EMISSION switch (2) set to CW.

(3) Press the key and adjust the A.F. GAIN control (5) for comfortable monitoring level.

(4) Hold the key down and increase the VOX GAIN control setting until the vox relay operates. To change the release time constant, adjust the VOX TIME CONSTANT potentiometer (R43). Clockwise rotation of this control increases the release time. This control is located on a bracket under the top cover, behind the meter.

(5) Set the meter switch (8) to ALC. While sending a series of dots, adjust the MIC GAIN control (4) for S3 meter reading of ALC.

NOTE

Component heating during operation may cause the ALC reading to decrease. Maintain the ALC reading at S3 by adjusting the MIC GAIN control (4) as required.

(6) When receiving, leave the A.F. GAIN control (5) set for a comfortable monitoring level, and adjust the receive level with the R.F. GAIN control (10). When the Collins KWM-2/2A is receiving, the received signal is indicated in S-units. The S-meter will read correctly with the R.F. GAIN control (10) at less than maximum setting, provided the received signal level is high enough to actuate the S-meter. For example, if the R.F. GAIN control (10) is set for no-signal reading of S8 and reads S9 with signal, the received signal is S9.

d. Mobile Operation. The vox and antivox circuits will operate in mobile operation, but push-to-talk operation is recommended, since high level background noises will produce undesirable vox switchover. Set the VOX GAIN and ANTIVOX GAIN controls fully counterclockwise before installation. If vox operation is desired, leave clearance in installation so the top cover can be opened. For mobile operation, load the power amplifier to 210 ma plate current. (In some installations, power amplifier plate current readings less than 210 ma will be obtained due to cable length, cable size, and battery condition.)

3-13. Operation Outside Amateur Bands

a. Selection of Crystals. The crystals supplied in Crystal Unit Set, Quartz CK-31/FRC-93 cover the frequency ranges of 3.4 to 5.0 MHz and 6.5 to 30 MHz. Figure 3-6 shows crystal socket locations. Select these crystals as follows:

(1) If the lower edge of the desired 200-kHz band is 11.8 MHz or less, the required frequency is equal to the lower edge of the desired band plus 3.155 MHz. For example, if the desired band is 4.0 to 4.2 MHz, 4.0 MHz plus 3.155 MHz equals 7.155 MHz.

(2) If the lower edge of the desired 200-kHz band is 12.00 MHz or higher, the required

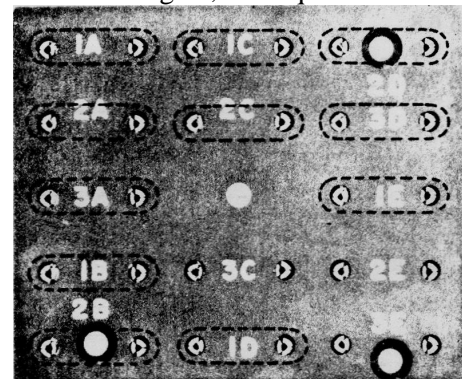

Figure 3-6. Crystal socket locations

TM 11-5820-554-12

frequency is half the sum of the lower edge of the desired band and 3.155 MHz. *For example:*

$$\frac{14.4 + 3.155}{2} = 8.7775 \text{ MHz}$$

The plate circuit of the oscillator is tuned to twice the crystal frequency when required injection frequencies are this high.

CAUTION

Avoid transmitter operation between 5.0 and 6.5 MHz. In this range, the second harmonic of the variable IF is nearly the same as the desired frequency. In the transmit function, some of this energy will pass through the tuned circuits and become spurious emissions.

(3) Plug substitute or extra crystals into the appropriate socket on the mounting board according to BAND switch position and total coverage columns in table 3-2. The example given in (2) above calls for placement of the crystal in one of the sockets marked C. If two additional 10-meter crystals are used, they must be plugged into the sockets marked E. Table 3-2 lists crystal socket designations, switch positions (BAND), crystal frequencies, and frequency range limitations. The KWM-2A is equipped with an extra

crystal mounting board and a front panel switch to allow selection of either board. The crystal-mounting board for extra-band operation is located on top of the chassis. If amateur band operation is not needed, extra-band crystals may be substituted in the crystal-mounting board under the chassis. BE SURE the crystals are plugged into appropriate sockets according to table 3-2 and figure 3-6. The transmitter can be operated at other frequencies outside the specified amateur bands or at other 10-meter frequencies by plugging the proper crystals into the mounting boards. Mark the desired lower band edge information on the white card in the BAND switch windows. Make sure this information is marked in the appropriate switch positions.

b. Adjustment of Tubbed Circuits. For operation outside amateur bands, disregard amateur-band markings on the EXCITER TUNING and P.A. TUNING scales and use logging scales (fig. 3-5). Operation at frequencies outside the amateur bands will result in slightly decreased receiver sensitivity and transmitter pa grid drive, unless the tuned circuits of the transceiver are retained to peak their responses in the desired portion of the high-frequency spectrum.

Table 3-2. Crystal Frequencies and Operating Bands

<i>KWM-2/2A</i> Operating frequency (MHz)	<i>Crystal</i> frequency (kHz)
Bandswitch setting 1A, 2A, or 3A	
4.0 to 4.2	7155.0
4.2 to 4.4	7355.0
4.4 to 4.6	7555.0
4.6 to 4.8	7755.0
4.8 to 5.0	7955.0
Bandswitch setting 1B or 2B	
6.6 to 6.8	9755.0
6.8 to 7.0	9955.0
7.0 to 7.2	*10155.0
7.2 to 7.4	*10355.0
7.4 to 7.6	10555.0
7.6 to 7.8	10755.0
7.8 to 8.0	10955.0
8.0 to 8.2	11155.0
8.2 to 8.4	11355.0
8.4 to 8.6	11555.0
8.6 to 8.8	11755.0
8.8 to 9.0	11955.0
9.0 to 9.2	12155.0
9.2 to 9.4	12355.0
9.4 to 9.6	12555.0

See footnote at end of table.

TM 11-5820-554-12

KWM-2/2A
operating frequency
(MHz)

Crystal
frequency
(kHz)

Bandswitch setting 1C, 2C, or 3C

9.4 to 9.6	-----	12555.0
9.6 to 9.8	-----	12755.0
9.8 to 10.0	-----	12955.0
10.0 to 10.2	-----	13155.0
10.2 to 10.4	-----	13355.0
10.4 to 10.6	-----	13555.0
10.6 to 10.8	-----	13755.0
10.8 to 11.0	-----	13955.0
11.0 to 11.2	-----	14155.0
11.2 to 11.4	-----	14355.0
11.4 to 11.6	-----	14555.0
11.6 to 11.8	-----	14755.0
11.8 to 12.0	-----	14955.0
12.0 to 12.2	-----	7577.5
12.2 to 12.4	-----	7677.5
12.4 to 12.6	-----	7777.5
12.6 to 12.8	-----	7877.5
12.8 to 13.0	-----	7977.5
13.0 to 13.2	-----	8077.5
13.2 to 13.4	-----	8177.5
13.4 to 13.6	-----	8277.5
13.6 to 13.8	-----	8377.5
13.8 to 14.0	-----	8477.5
14.0 to 14.2	-----	*8577.5
14.2 to 14.4	-----	*8677.5
14.4 to 14.6	-----	8777.5
14.6 to 14.8	-----	8877.5
14.8 to 15.0	-----	*8977.3

Bandswitch setting 1D, 2D, or 3D

15.0 to 15.2	-----	9077.5
15.2 to 15.4	-----	9177.5
15.4 to 15.6	-----	9277.5
15.6 to 15.8	-----	9377.5
15.8 to 16.0	-----	9477.5
16.0 to 16.2	-----	9577.5
16.2 to 16.4	-----	9677.5
16.4 to 16.6	-----	9777.5
16.6 to 16.8	-----	9877.5
16.8 to 17.0	-----	9977.5
17.0 to 17.2	-----	10077.5
17.2 to 17.4	-----	10177.5
17.4 to 17.6	-----	10277.5
17.6 to 17.8	-----	10377.5
17.8 to 18.0	-----	10477.5
18.0 to 18.2	-----	10577.5
18.2 to 18.4	-----	10677.5
18.4 to 18.6	-----	10777.5
18.6 to 18.8	-----	10877.5
18.8 to 19.0	-----	10977.5
19.0 to 19.2	-----	11077.5
19.2 to 19.4	-----	11177.5

*See footnote at end of table.

TM 11-5820-554-12

KWM-2/2A

*Operating frequency
(MHz)*

*Crystal
frequency
(kHz)*

19.4 to 19.6	11277.5
19.6 to 19.8	11377.5
19.8 to 20.0	11477.5
20.0 to 20.2	11677.5
20.2 to 20.2	11677.5
20.4 to 20.6	11777.5
20.5 to 20.8	11877.5
20.8 to 21.0	11977.5
21.0 to 21.2	*12077.5
21.2 to 21.4	*12177.5
21.4 to 21.6	*12277.5
21.6 to 21.8	12377.5
21.8 to 22.0	12477.5
Bandswitch setting 1E ,2E, or 3E	
22 .0 to 22.2	12677.5
22.2 to 22.4	12677.5
22.4 to 22.6	12777.5
22.6 to 22.8	12877.5
22.8 to 23.0	12977.5
23.0 to 23.2	13077.5
23.2 to 23.4	13177.5
23.4 to 23.6	13277.5
23.6 to 23.8	13377.5
23.8 to 24.0	13477.5
24.0 to 24.2	13577.5
24.2 to 24.4	13677.5
24.4 to 24.6	13777.5
24.6 to 24.8	13877.5
24.8 to 25.0	13977.5
25.0 to 25.2	14077.5
25.2 to 25.4	14177.5
25.4 to 25.6	14277.5
25.6 to 25.8	14377.5
25.8 to 26.0	14477.5
26.0 to 26.2	14677.5
26.2 to 26.4	14677.5
26.4 to 26.6	14777.5
26.6 to 26.8	14877.5
26.8 to 27.0	14977.5
27.0 to 27.2	15077.5
27.2 27.4	15177.5
27.4 27.6	15277.5
27.6 to 27.8	15377.5
27.8 to 28.0	15477.5
28.0 to 28.2	15577.5
28.2 to 28.4	15677.5
28.4 to 28.6	15777.5
28.6 to 28.8	15877.5
28.8 to 29.0	15977.5
29.0 to 29.2	16077.5
29.2 to 29.4	16177.5
29.4 to 29.6	16277.5
29.6 to 29.8	16377.5
29.8 to 30.0	16477.5

*Not supplied with Crystal Unit Set, Quartz CK-31/FRC.

Section IV. CIRCUIT FUNCTIONING

3-14. Block Diagram (fig. FO-1)

The Collins KWM-2/2A is an ssb or a cw transceiver operating in the range between 4.0 to 30 MHz. It consists of a double-conversion receiver and a double-conversion exciter-transmitter. The transmitter and receiver circuits use common oscillators, a common mechanical filter, and a common RF amplifier. The transmitter low-frequency IF and the receiver low-frequency IF is 455 kHz. The high-frequency IF for both is 2.955 to 3.155 MHz. This a bandpass IF which accommodates the full 20-kHz bandwidth.

3-15. Transmitter Circuits

a. Af Circuits. Microphone or phone patch is connected to first transmit audio amplifier V1A, amplified and connected to second transmit audio amplifier V11B. The output of V11B is coupled to third transmit audio amplifier V3A, amplified and coupled to balanced modulator CR1 through CR4. In the TUNE, LOCK, and CW positions of the EMISSION switch, the output of tone oscillator V2B is applied to second transmit audio amplifier V11B. The amplified tone oscillator signal at the output of V11B is applied to vox amplifier V14B to activate the vox circuits in cw operation. This signal is also applied to first receiver at amplifier V16A for cw monitoring.

b. Balanced Modulator and Low-Frequency IF Circuits. Audio output from third transmit audio amplifier V3A and beat-frequency oscillator (bfo) V11A voltage are applied to the balanced modulator (CRT, CR2, CR3, and CR4). Both upper and lower sideband outputs from the balanced modulator are applied to transmit IF amplifier V4A. The output from the IF amplifier is applied to mechanical filter FL1. The passband of FL1 is centered at 455 kHz. This passes either the upper or lower sideband depending upon the sideband selected when the EMISSION switch connects the bfo upper or lower sideband crystal. The single-sideband output of FL1 is applied to first transmit mixer V5. The mixer cancels the vfo signal energy and translates the 455-kHz single-sideband signal from the balanced modulator to a 2.955- to 3.155 MHz single-sideband signal. The output of the first transmit mixer is applied through variable IF tuning T2 to second transmit mixer V6. The high-frequency injection energy from crystal oscillator V13 A is also applied to mixer V6. This arrangement cancels the high-frequency

injection signal within the mixer and translates the bandpass IF signal to the desired operating band.

c. RF and ALC Circuits. The output of transmit mixer V6 is applied to receive/transmit amplifier V7. The amplified output of V7 is applied to driver V8 to drive power amplifier V9 and V10. The output of the power amplifier is fed to the antenna through contacts of transmit-receive relay K3. Negative feedback from the pa plate circuit to driver V8 reduces distortion in the output signal. Both the driver and pa stages are neutralized to insure stability. When the RF driving voltage to the pa becomes great enough that positive peaks drive the pa grid positive, the grids begin to draw current and the signal is detected. This produces an audio envelope. The audio is rectified by ALC rectifier V17A, which is connected to produce a negative d.c. voltage. This voltage is filtered and is used to control the gain of transmit IF amplifier V4A and receiver/transmit RF amplifier V7. This system allows a high average level of modulation without overdriving power amplifier V9 and V10 which would result in increased distortion.

3-16. Receiver Circuits

a. RF Circuits. The signal input from the antenna is applied through relay contacts to receive/transmit amplifier V7. The output of V7 is fed to first receive mixer V13B.

b. Receiver Mixers. The high-frequency injection signal is fed to V13B. The difference product of the first mixer is applied to variable IF tuning T2. The output of T2 in the range of 2.995 to 3.155 MHz is applied to second receive mixer V17B. The vfo injection signal is applied to V17B. The 455-kHz difference product is applied to mechanical filter FL1.

c. IF Circuits. The output from FL1 is applied to first receive IF amplifier V1B. The output of V1B is applied to second receive IF amplifier V3B and to the age detector. The output of V3B is fed to product detector V15B. The beat-frequency oscillator signal is applied to the product detector, and the product of the mixing is the detected audio signal. The output of the age rectifier circuit is applied to the two receive IF amplifiers and to receive/transmit RF amplifier V7. This avc voltage controls the gain of the receiver and prevents overloading.

d. If Circuits. The output from the product detector is applied to first audio amplifier V16A. The amplified audio output of V16A is applied to second

audio amplifier V16B, which produces the power to operate a speaker, headphones, or a phone patch.

3-17. Oscillators

The transceiver contains the tone oscillator, the beat-frequency oscillator, the variable-frequency oscillator, the high-frequency oscillator, and the crystal calibrator.

a. Tone Oscillator. The tone oscillator operates when the EMISSION switch is at LOCK, TUNE, or CW. It is a phase shift oscillator operating at approximately 1,750 Hz. Its output is fed to the transmitter audio circuits for cw operation. Some of the output from the tone oscillator is applied to the receiver audio circuits for sidetone monitoring in cw operation. Because of the 1,750 Hz tone applied to the balanced modulator during cw operation, the actual transmitted signal will be 1,750 Hz above the Collins KWM-212A dial reading.

b. Beat-Frequency Oscillator. The bfo is crystal-controlled at either 453.650 or 456.350 kHz, depending on whether Y16 or Y17 is selected by the EMISSION switch. The unused crystal is shorted out by the switch. These crystal frequencies are matched to the passband of mechanical filter FL1 so that the carrier frequency is placed approximately 20 db down on the skirts of the filter response. This 20-db carrier attenuation is in addition to the 30-db suppression provided by the balanced modulator.

c. Variable-Frequency Oscillator. The vfo uses fixed capacitors and variable inductance to tune the range of 2.5 to 2.7 MHz. Its output is applied direct to second receive mixer V17B, and is applied to second transmit mixer V6 through vfo cathode follower V2A.

d. High-Frequency Crystal Oscillator. High-frequency crystal, oscillator V 13A is crystal-controlled by 1 of 14 crystals selected by bandswitch S2. The output from the high-frequency crystal oscillator is applied to the transmitter second mixer and to crystal oscillator cathode follower V12A. The cathode follower provides isolation and impedance match between the crystal oscillator and receiver

first mixer V13B. The output frequency of this oscillator is always 3.155 MHz higher than the lower edge of the desired band. This high-frequency injection signal is the crystal fundamental frequency for all desired signals below 12 MHz. For operating frequencies above 12 MHz, the crystal frequency is doubled in the plate circuit of the oscillator. Instructions for calculating crystal frequencies for the desired bands are given in paragraph 3-13a

e. Crystal Calibrator. The output of crystal calibrator V12B is coupled to the antenna and applied to the receive circuits. The output is used when calibrating the tuning dial.

3-18. Vox and AntivoX Circuits

Audio output voltage from second microphone amplifier V1B is coupled through the VOX GAIN control to vox amplifier V14B. The amplified voltage is applied to vox rectifier V14A. The positive d.c. voltage output of the vox rectifier is applied to vex retry switch V4B, causing it to conduct and actuate vox relay K2. Contacts of K2 switch the antenna connection to the transmit circuits, the other relay coils, and bias voltage. Other relays switch the metering circuits from receive to transmit, the low plate voltages from receive to transmit tubes, and the AVC and ALC leads. The antivoX circuit provides a threshold voltage to prevent loudspeaker output (picked up by the microphone circuits) from tripping the Collins KWM-2/2A into transmit functions. Some of the receiver output audio voltage is applied through the ANTIVOX GAIN control to antivoX rectifier V14A. Negative d.c. output voltage from the antivoX rectifier, applied to vox relay switch V4B, provides the necessary antivoX threshold. The ANTIVOX GAIN control adjusts the value of the antivoX threshold so that the loudspeaker output will not produce enough positive d.c. output from the vox rectifier to exceed the negative d.c. output from the antivoX rectifier and cause V4B to actuate K2. However, speech energy into the microphone will cause the positive vex voltage to overcome the negative antivoX voltage and produce the desired action of K2.

Section V. OPERATOR'S MAINTENANCE INSTRUCTIONS

NOTE

The instructions in paragraphs 3-23 and 3-24 are applicable for the operator's maintenance portions of chapter 4 through 13

3-19. Scope of Operator's Maintenance

The maintenance duties assigned to the operator of the RT-718/FRC-93 follows:

NOTE

Refer to TM 750-244-2 for proper procedures for destruction of this equipment to prevent enemy use.

- a. Operator/crew preventive maintenance is the systematic care, servicing and inspection of equipment to prevent the occurrence of trouble to reduce downtime and to maintain equipment in serviceable condition. To be sure that your

teletypewriter you must do scheduled preventive maintenance checks and services (PMCS).

(1) BEFORE OPERATION, perform your B PMCS to be sure that your equipment is ready to go.

(2) DURING OPERATION, perform your D PMCS. This should help you to spot small troubles before they become big problems.

(3) AFTER OPERATION, perform your A PMCS. This should help you to keep your equipment in top shape.

(4) WEEKLY AND MONTHLY PMCS are important checks to keep serious problems from suddenly happening. Perform WEEKLY as well as BEFORE OPERATION PMCS if:

(a) You are the assigned operator and have not operated the item since the last WEEKLY.

(b) You are operating the item for the first time.

(5) When an item of equipment is reinstalled after removal, for any reason, perform the necessary B PMCS (para 4-1) to be sure the item meets the readiness reporting criteria.

(6) Use the ITEM NO. column in the PMCS table to get the number to be used in the TM ITEM NO. column on DA Form 2404 (Equipment Inspection and Maintenance Worksheet) when you fill out the form.

b. Organizational preventive maintenance procedures are designed to help maintain equipment in serviceable condition. They include items to be checked and how to check them. These checks and services, described in paragraph 4-3, outline inspections that are to be made at specific weekly (W), Monthly (M), quarterly (Q), and semiannual (S) intervals.

c. Routine checks like CLEANING, DUSTING, WASHING, CHECKING FOR FRAYED CABLES, STOWING ITEMS NOT IN USE, COVERING UNUSED RECEPTACLES, AND CHECKING FOR LOOSE NUTS AND BOLTS are not listed as PMCS checks. They are things that you should do any time you see they must be done. If you find a routine check like one of those listed in your PMCS, it is because other operators reported problems with this item

NOTE

When you are doing any PMCS or routine checks, keep in mind the warnings and cautions.

WARNING

- Never operate the generator or shelter until it has been properly grounded. Electrical defects in the load lines or equipment can

cause death by electrocution when contact is made with an ungrounded system.

- Adequate ventilation should be provided while using TRICHLOROTRIFLUOROETHANE. Prolonged breathing of vapor should be avoided. The solvent should not be used near heat or open flame; the products of decomposition are toxic and irritating. Since TRICHLOROTRIFLUOROETHANE dissolves natural oils, prolonged contact with skin should be avoided. When necessary, use gloves which the solvent cannot penetrate. If the solvent is taken internally, consult a physician immediately.

- Compressed air is dangerous and can cause serious bodily harm if protective means or methods are not observed to prevent a chip or particle (of whatever size) from being blown into the eyes or unbroken skin of the operator or other personnel. Goggles must be worn at all times while cleaning with compressed air. Compressed air shall not be used for cleaning purposes except where reduced to less than 29 pounds per square inch gage (psig) and then only with effective chip guarding and personnel protective equipment. Do not use compressed air to dry parts when trichlorotrifluoroethane has been used.

NOTE

The PROCEDURES column in your PMCS charts instruct how to perform the required checks and services. Carefully follow these instructions and, if tools are needed or the chart so instructs, get organizational maintenance to do the necessary work.

If your equipment must be in operation all the time, check those items that can be checked and serviced without disturbing operation. Make the complete checks and services when the equipment can be shut down.

- d.* Deficiencies that cannot be corrected must be reported to higher category maintenance personnel. Records and reports of preventive maintenance must be made in accordance with procedures given in TM 38-750. Paragraphs 3-20, 3-21 and 3-22 deleted.

TM 11-5820-554-12

3-23. Operator/Crew Preventive Maintenance Checks and Services, Receiver Transmitter RT-718/FRC-93

Perform weekly as well as before operation PMCS if:

Item No.	Interval					Item to be inspected	Procedure	Equipment is not ready/available if.
	B	D	A	W	M			
1			•			Antenna system and receiver front end after electrical storms.	Check for loss of receiver sensitivity particularly after thunderstorms. Use receiver "S" meter on signal of known strength.	Receiver sensitivity falls below level for mission communications reliability.
2			•			Antenna system and transmitter final.	Observe plates of transmitter final for signs of operating too hot. Check VSWR on transmitter output for high VSWR.	If antenna system cannot be corrected within time needed to maintain mission communications.
3			•			Transmitter frequency stability.	Check with distant station to determine whether station transmitter frequency is drifting.	If transmitter stability causes loss of reliable communications.
4			•			Crystals	Check crystal selected for use in transmitter for proper operation.	If spare crystal of selected frequency is not available and no alternate frequency is available to fulfill mission`
5					•	Power resistor in final and drivers.	Inspect power resistors in final and driver biasing circuits for signs of discoloration or cracking. Also check final tank coils for signs of corrosion or overheating. Have distant station check signal quality, and tune adjacent frequencies to check for spurious signals.	Improper transmitter operation generates interference due to faulty tuning circuits or amplifier bias.

- a. You are the assigned operator and have not operated the item since the last weekly.
- b. You are operating the item for the first time.

NOTE

The checks in the interval column are to be performed in the order listed.

3-24. Cleaning

Inspect the exterior of the equipment. The exterior surfaces should be free of dirt and fungus

- a. Remove loose dirt with a clean, soft cloth.

WARNING

Adequate ventilation should be provided while using TRICHLOROTRIFLUOROETHANE. Prolonged breathing of vapor should be avoided. The solvent should not be used near heat or open flame; the products of

decomposition are toxic and irritating. Since TRICHLOROTRIFLUOROETHANE dissolves natural oils, prolonged contact with skin should be avoided. When necessary, use gloves which the solvent cannot penetrate. If the solvent is taken internally, consult a physician immediately.

- b. Remove grease, fungus, and ground-in dirt from the equipment with a cloth dampened with TRICHLOROTRIFLUOROETHANE.

Section VI. ORGANIZATIONAL MAINTENANCE INSTRUCTIONS

NOTE

The instructions given in paragraph 3-25, 3-26, and 3-27 are applicable for the organizational maintenance portions of chapters 4 through 13.

3-25. Scope of Organizational Maintenance

Organizational maintenance consists of continuity checks, replacing fuses, tubes, and performing the following:

a Quarterly preventive maintenance (para 3-27 and 3-28).

b. Touchup painting (para 3-29).

3-26. Tools, Materials, and Test Equipment Required

a Tools, Tool Kit, Electronic Equipment TK-101/G is required.

b. *Materials.*

(1) TRICHLOROTRIFLUOROETHANE NSN 6850-00-105-3084

(2) Cleaning cloth.

c. Test Equipment

<i>Equipment</i>	<i>National stock No.</i>	<i>Quantity required</i>	<i>Applicable literature</i>
Multimeter AN/USM-223	6625-00-999-7465	1	TM 11-6625-654-14
Test Set, Electron Tube TV-7D/U	6625-00-820-0064	1	TM 11-6625-274-12
Tool Kit, Electronic Equipment TK-101/G	5180-00-064-5178	1	SC 5180-91-CL-R13

3-27. Quarterly Preventive Maintenance

Quarterly preventive maintenance checks and services on the equipment is required. All deficiencies or shortcomings will be recorded in accordance with the requirements of TM 38-750. Perform all checks and services listed in the organizational quarterly preventive maintenance checks and services chart in the sequence listed.

3-28. Organizational Preventive Maintenance Checks and Services Chart for Receiver-Transmitter RT-718/FRC-93

Interval Item No.	W-Weekly			M-Monthly	Q-Quarterly	Procedures
	W	M	Q			
						Check operation of radio receiver for possible loss of sensitivity. Check operation of transmitter on a series of frequencies to test for deterioration of tuning.

3-29. Touchup Painting

When the finish on the metal parts of the equipment has been badly scarred or damaged, lightly sand them with fine sandpaper. Use #00 or #000 sandpaper and TRICHLOROTRIFLUOROETHANE to clean the surface down to the bare metal. Brush two thin coats

of paint on the bare metal. Refer to applicable cleaning and refinishing practices in TB 43-0118.

3-30. Administrative Storage

Administrative storage of this equipment shall be accomplished by wrapping the equipment with paper and securing with packaging tape. Use a small bag of dessicant inside the package.

CHAPTER 4 CRYSTAL UNIT SET, QUARTZ CK-31/FRC-93

4-1. Description

Crystal Unit Set, Quartz CK-31/FRC-93 (Collins Crystal Packet CP-1) consists of a packet, a set of crystals for operation of the Collins KWM-2/2A over their complete frequency range, and a set of crystal grippers for use in installing and removing crystals from the equipment. The crystals not supplied are those for the range of 5.0 to 6.6 MHz. Operation between 5.0 and 6.6 MHz is not desirable because of spurious responses of the equipment due to the second harmonics of the variable

I F stages. The packet is a waterproof plastic material containing a pouch for each crystal and one for the crystal grippers. The complete packet may be snapped and strapped into the Collins CC-2 for transportation as part of a transportable station. The folded packet is shown in figure 4-1. The unfolded packet showing grippers and the individual pouches for the crystals is shown in figure 4-2. Each crystal pouch is marked with appropriate band information and crystal frequency.

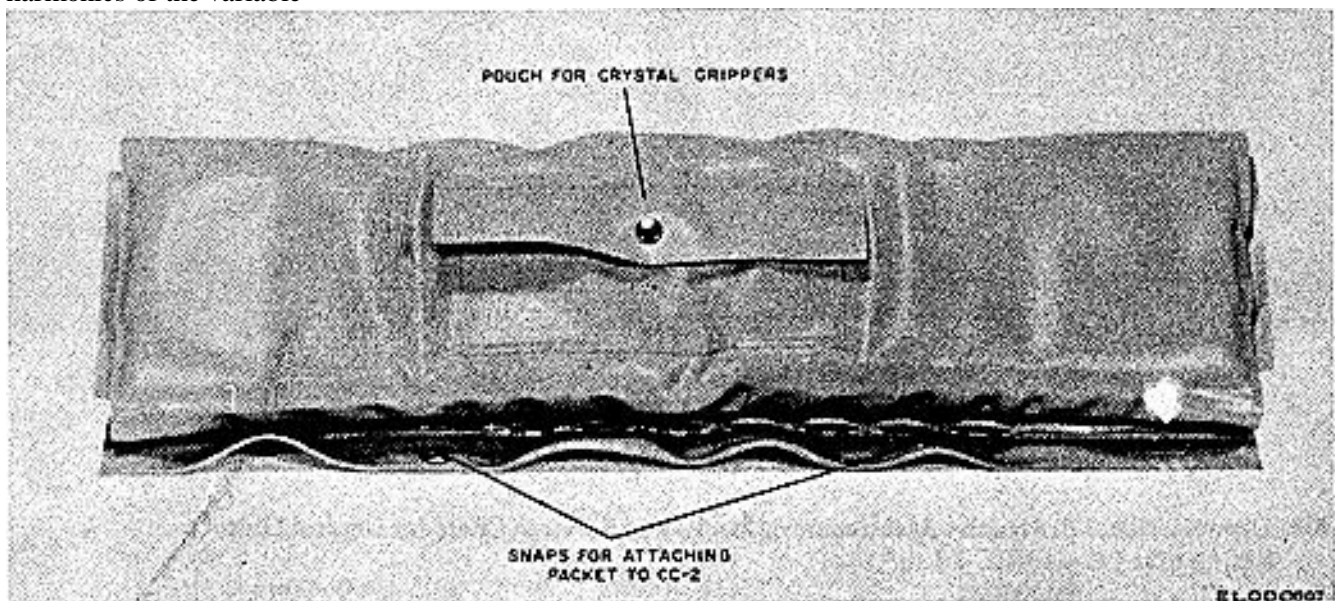

Figure 4-1. Crystal packet, folded.

4-2. Use

Unlock the crystal grippers, and grasp the crystal in the equipment with them. Figure 4-3 shows a crystal gripped the proper way. Apply enough pressure on the grippers to prevent slipping, and pull the crystal from its socket. Place the crystal in the pouch marked for it with the pins showing from the open end. Refer to table 3-2 to determine the proper crystal for the frequency band to be

used. Remove the desired crystal from its pouch, grip with the tool, and insert it in the socket determined by table 3-2.

4-3. Operator's Maintenance Instructions

Other than keeping the pouch free of dust, no regular operator's maintenance is required. Organizational maintenance is required.

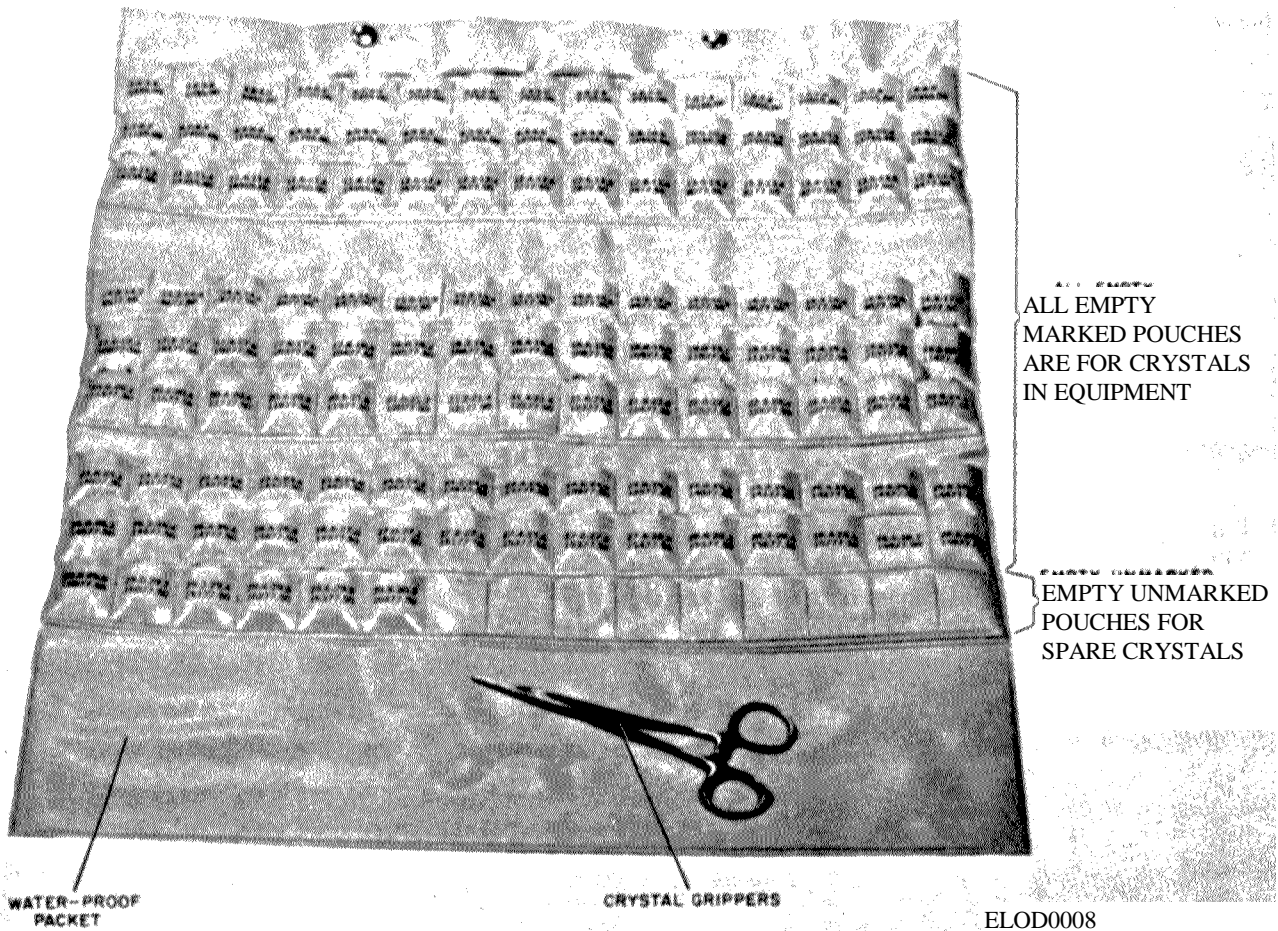
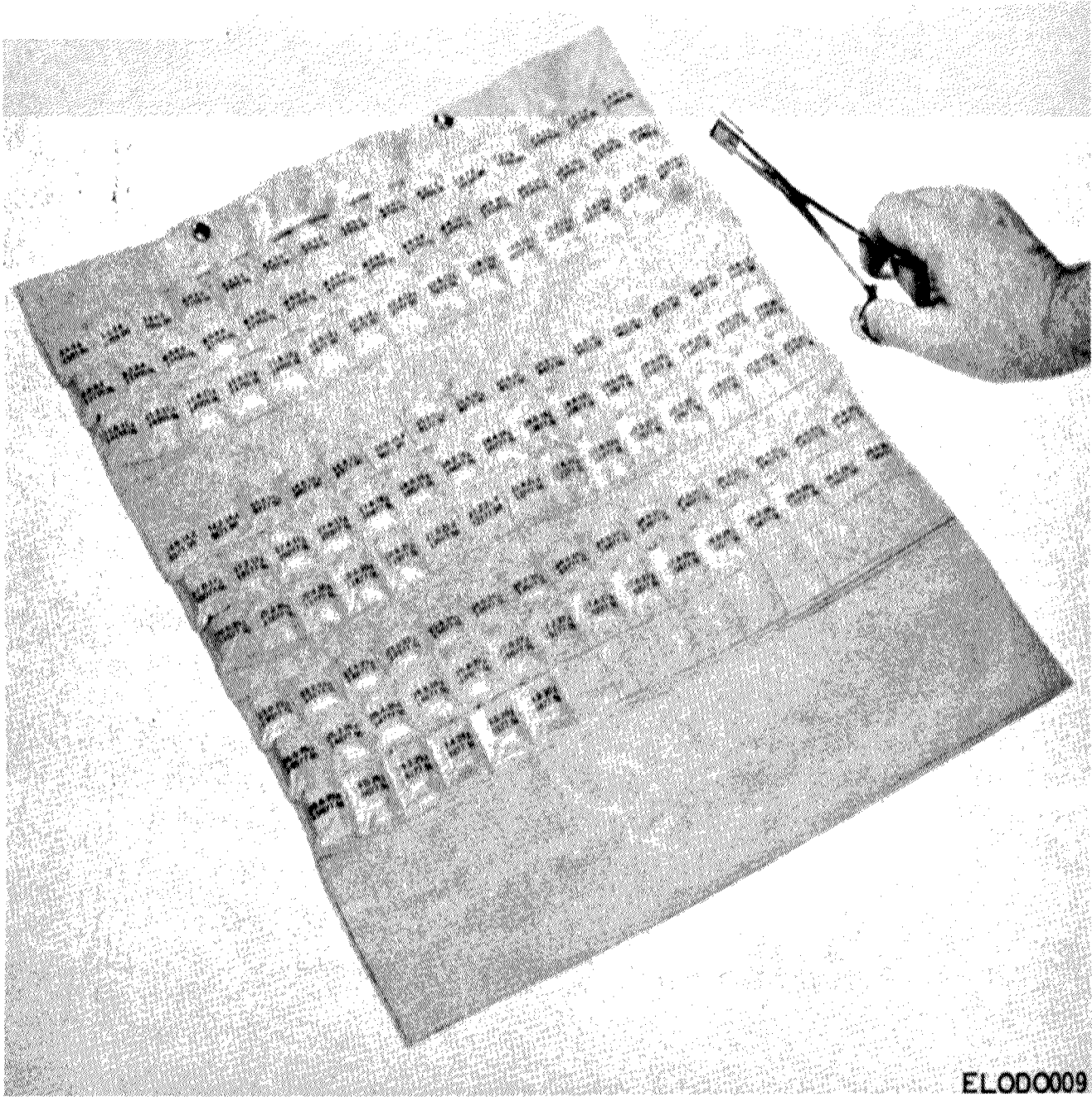

Figure 4-2. Crystal packet, unfolded

4-4. Organizational Preventive Maintenance Checks and Services Chart for Crystal Unit Set, Quartz CK-31/FRC-93

Item No.	W-Weekly Interval			M-Monthly	Q-Quarterly
	W	M	Q	Item to be inspected	Procedures
			•	Crystals	Check crystals not in use with crystal test set to insure correct operation



ELODO009

ELDO0009

Figure 4-3. Method of holding crystal

CHAPTER 5
Q-MULTIPLIER/NOTCH FILTER

Section I. INTRODUCTION

NOTE

The Waters Q-Multiplier/notch filter was originally purchased and installed in the RT718/FRC-93 transceivers for use in Europe. This item is no longer in the supply system for replacement; however, the information in this chapter is retained to provide maintenance information for those which are still in use.

5-1. Description

a. The Q-multiplier/notch filter (Waters 340-A), hereafter referred to as the Multiplier/notch filter, is designed to increase the operating capacities of Receiver-Transmitter RT-718/FRC-93 by providing the ability to tune out interfering signals. It provides facility for simultaneous fixed-station use of the external permanently tuned oscillator (pto) (Collins 312B-5) together with the Multiplier.

b. The Multiplier/notch filter operates at 455 kHz ± 2.6 Hz. Its tunable notch depth is 40 db at any point in the entire IF passband. While the usefulness of the

Multiplier/notch filter is greatest in the rejection of heterodynes, it is also useful in rejecting all types of interfering signals such as continuous wave (cw), amplitude modulation (am.), and single sideband signals (ssb) that are close to the desired signal.

c. The mechanical design of the Multiplier/notch filter when installed in the Collins KWM-2/2A will not detract from the equipment's original appearance or electrical performance. It may be installed in approximately 1 hour.

5-2. Items Comprising an Operable Q-Multiplier/Notch Filter

<i>NSN</i>	<i>Item</i>	<i>Qty</i>
5915-00-911-2333	Filter, band suppression kit w/attached coaxial cable 94603; Q-multiplier/notch filter (Waters 340-A)	1
	Capacitor assembly group; MSA-B-340-26 (including MSA-B340 1 and MSA-B340 41); 94603	1
	Filter assembly MSA-B34-10; 94603	1
	Installation kit group: type 340-A; 94603	1
5960-00-166 7664	Electron tube 12AX7, 81349	1

Section II. OPERATION

5-3. Adjusting Q-Multiplier/Notch Filter

a. Turn the new inner knob to ON. Allow the transceiver to warm up for 10 minutes.

b. Turn the inner knob to CAL, the EMISSION switch (on Collins KWM-2/2A) to USB, and tune the vfo dial to a crystal calibrator frequency; for example, 4.000 MHz. Set the AF GAIN control to maximum, and the RF GAIN control between 3 and 5 o'clock.

c. Set the REJECTION TUNING knob (outer knob) at 12 o'clock. The capacitor plates will be at half mesh.

d. Tune the vfo dial to 1.1. kHz lower frequency than zero beat. The tone in the speaker will be 1.1 kHz.

e. Two null positions may be found when adjusting the tuning screw in L1. Use that position found when the screw is turned ccw and is farthest out. Rotate the tuning screw slowly for a null at 1.1 kHz. tone.

Change 5

TM 11-5820-554-12

f. Adjust potentiometer R8 for minimum tone. Alternately, readjust both L1 and R8 for the best null.

g. Retune the vfo dial and the rejection tuning. The tone may be found and pulled.

h Replace the antenna connection on the rear of the chassis.

NOTE

The Q-multiplier/notch filter (Waters 340-A) will operate in the Collins KWM-2/2A with either the a.c. power supplies (PP-4151/95 or PP-3990/ FRC-93), the mobile direct current (d.c.) supplies (PP-4765/GRC-159(V) (24 volts)), or the Collins MP-1 (12 volts). The external permanently tuned oscillator (pto) C-7517/FRC-93 may not be used simultaneously unless the a.c. power supplies are used because of heater voltage distribution.

5-4. Q-Multiplier/-Notch Filter Effectiveness

The Q-Multiplier/notch filter effectiveness can be increased when RF GAIN control R8 is less than maximum. When the Q-multiplier/notch filter is not necessary, it should be tuned out of the passband (dial pointer in the horizontal position). The Q-multiplier/notch filter does not cause reduction in the receiver sensitivity; therefore, an in and out switch is not provided. Variable capacitor C6 in this unit may be rotated continuously. There will always be two positions 180 degrees apart at which a signal can be notched out.

5-5. Use of External Vfo

When the external vfo is to be used (only with the PP-4151/FRC-93 or PP-3990/FRC-93), remove the shorting plug from the new socket (J17). Insert the vfo plug.

Section III. OPERATOR'S MAINTENANCE INSTRUCTIONS

5-6. General

The instructions contained in paragraphs 3 19 through 3-22, and 3-24 are applicable for the operator's maintenance duties. Paragraph 5-7 contains the operator's daily preventive maintenance checks and services chart. Cleaning is covered in paragraph 3-24.

Perform weekly as well as before operation PMCS if:

- a You are the assigned operator and have not operated the item since the last weekly.
- b. You are operating the item for the first time.

NOTE

The checks in the interval column are to be performed in the order listed.

5-7. Operator/Crew Preventive Maintenance Checks and Services

Item No.	Interval					Item to be inspected	Procedures	Equipment is not ready/ available if:
	B	D	A	W	M			
	•				•	Notch filter tuning	Check to insure that an interfering signal can be notched out. Use external signal generator to insert signal at points in full range of notch filter tuning.	If filter is incapable of reducing interference that causes failure of mission.

Section IV. Deleted.

CHAPTER 6
FILTER, RADIO INTERFERENCE F-1 139/GRC-1 59(V)

6-1. Introduction

Filter, Radio Interference, F-1139/GRC-159(V)(noise blanker) (Collins 136B-2), hereafter referred to as the noise blanker, converts noise to bias pulses for gating the receive circuits of the Collins KWM-2/2A. This action minimizes receiver output noise that results from radiated noise present on both the noise blanker and receiver antennas. Noise present in the 40.0-MHz portion of the spectrum occurs simultaneously with that in the high frequency (3 to 30 MHz) portion. The noise blanker should be provided with its own separately tuned 40.0-MHz antenna. Although a 6-foot quarter wave, coaxial-fed whip is best in a mobile installation, in some instances a broadcast whip can be used with reduced performance. This can be accomplished without disabling the broadcast receiver if adequate isolation is provided (fig. 6-1).

6-2. Tabulated Data

Power source	Companion receiver power supply.
Frequency range	The blanking gate of the noise blanker passes IF signals in the range of 1.5 to 4.0 MHz in the companion transceiver. The input frequency range of the noise

blanker is 40.0 MHz with a minimum bandwidth of 1 MHz and a maximum bandwidth of 2 MHz

Sensitivity.....	A pulse signal input to the noise blanker of 100 microvolts will cause a minimum of 35 db reduction of gain in the receiver signal path
Spurious response.....	Internal noise and signals introduced by the noise blanker are less than 1.0- equivalent signal.
Input impedance	Noise-blanker amplifier: 50 ohms nominal \pm 50 percent unbalanced.
Output impedance.	Signal blanking circuit: high impedance.
Controls.....	Installation of the noise blanker requires the addition of an RF gain control (furnished with the kit).
Tube complement functions	Three RF noise and pulse amplifiers, one IF input and output amplifier

6-3. Installation

Installation of the noise blanker is not authorized at the organizational category. It is installed at direct support category(TM 11-5820-554-34-8).

6-4. Items Comprising an Operable Filter, Radio Interference F-1 139/GRC-1 59(V) .

NSN	Item	Qty	Height	Dimensions(in)			Weight (lb.)
				Depth	Width		
5820-00-960-8526 (Collins 136B-2).	Filter, Radio Interference WF 81139/GRC-159(V) noise blanker	1	4 11/16	1 7/8	6 3/8	1 1/4	

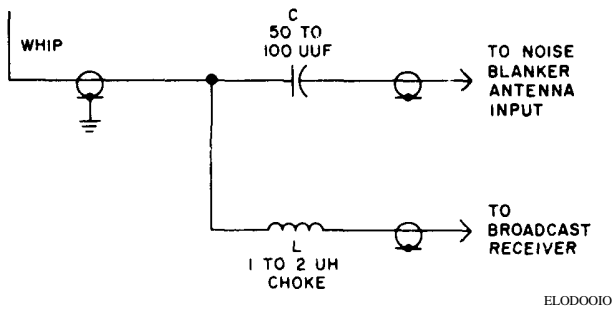

Figure 6-1. Suggested connections for using broadcast whip for both broadcast receiver and noise blanker.

6-5. Operation

Set the function switch to NB. After a sufficient warm-up period, turn the noise blanker gain control clockwise until the noise level indicated on the S-meter drops sharply. This is the threshold point of most efficient noise blanker operation. Additional noise blanker gain is not desirable and will degrade performance. The required noise blanker gain setting is not a set and forget adjustment. Changing conditions, such as those encountered in driving from one area into another, will change

TM 11-5820-554-12

the requirements for noise blanker gain setting. Whenever the noise level appears to have risen, reduce the noise blanker gain, and readjust for the threshold condition described above. If the noise blanker fails to reduce the noise level, turn it off. The repetition of the noise pulses may be too rapid for the blanker to gate, or a strong adjacent channel carrier may be causing erratic blanking.

6-6. Circuit Functioning (fig. 6-2)

The first three RF amplifier stages are connected as a 40-MHz tuned RF amplifier. The gain of the RF amplifier is controlled by the gain control. The output of the third RF amplifier (V3A) is limited by the action of limited diode CR8. The output of the third RF amplifier is detected by noise detector CRT. A resistive-capacitive network determines the length of the blanking pulse. The audio component of the noise detector is limited by limited CR2 and applied to the first pulse amplifier V3B). Any negative portion of the output waveform is clipped by limited CR 4. The positive portion is applied to the second pulse amplifier. The output of this amplifier is applied to the third pulse amplifier. Pulse shaper CR3 is connected between the output and input of V1B. The output of V1B is applied through threshold gate CR7 to the center tap of T1. Variable IF input from J22 in the transceiver is applied through variable intermediate frequency (vif) cathode follower V4B to the primary of transformer T1. The bias applied to threshold gate CR7 keeps it cut off and at high impedance to the low level pulses, but high level pulses overcome the bias and pass into the gate circuit. Gating diodes CR5 and CR6 are biased to conduction for normal free operation. However, when a high amplitude noise burst occurs, the positive-going pulse passes through threshold gate CR7 and cuts off both CR5 and CR6. This action effectively disconnects the variable IF signal for the period of the blanking pulse. The length of the blanking pulse varies from a few microseconds to a maximum of 30 microseconds. Blanking pulse length is governed by the magnitude of the noise pulse appearing at the noise blanker antenna. For short duration noise disturbances in the variable IF,

6-9. Deleted.

the blanking pulses are short, while the greater noise bursts develop longer blanking pulses. Transformers T1 and T2 and the gating diodes are arranged in a balanced modulator configuration so that any noise which results from the gating action is canceled and prevented from entering the receiver circuits. Any discontinuity of signal resulting from the gating action is compensated for by tuned circuit restoration in the following stages of the receiver. Both sections of V4 serve to isolate the noise-operated gate circuit from the receiver circuits. Vif isolation amplifier V4A provides only enough gain to compensate for the small loss in the gate circuit, so that overall gain through the noise blanker is approximately unity. Filament power, B+ power, and bias voltage are taken from the Collins KWM2/2A power supply.

6-7. Limitations

The noise blanker circuitry has the following three limitations which decrease the blanking efficiency:

a. Noise pulses which have no energy distribution at 40 MHz will occur in the frequency spectrum of the radio receiver range. The noise blanker will not generate a blanking pulse and will permit passage of these noise pulses.

b. A very strong signal in the passband between the first and second mixers can be modulated by the blanking pulses. This modulation process will cause sidebands in the passband which result in decreased blanking efficiency. To minimize this modulation effect, a blanker on-off control and blanker RF gain control are provided on the Collins KWM-2/2A front panel.

c. Some corona noise and static disturbances have a repetition rate in excess of one hundred thousand pulses per second. The blanking efficiency decreases as the pulse repetition rate exceeds five thousand pulses per second.

6-8. Operator Maintenance Instructions

The noise blanker has no operator controls. No operator maintenance is required.

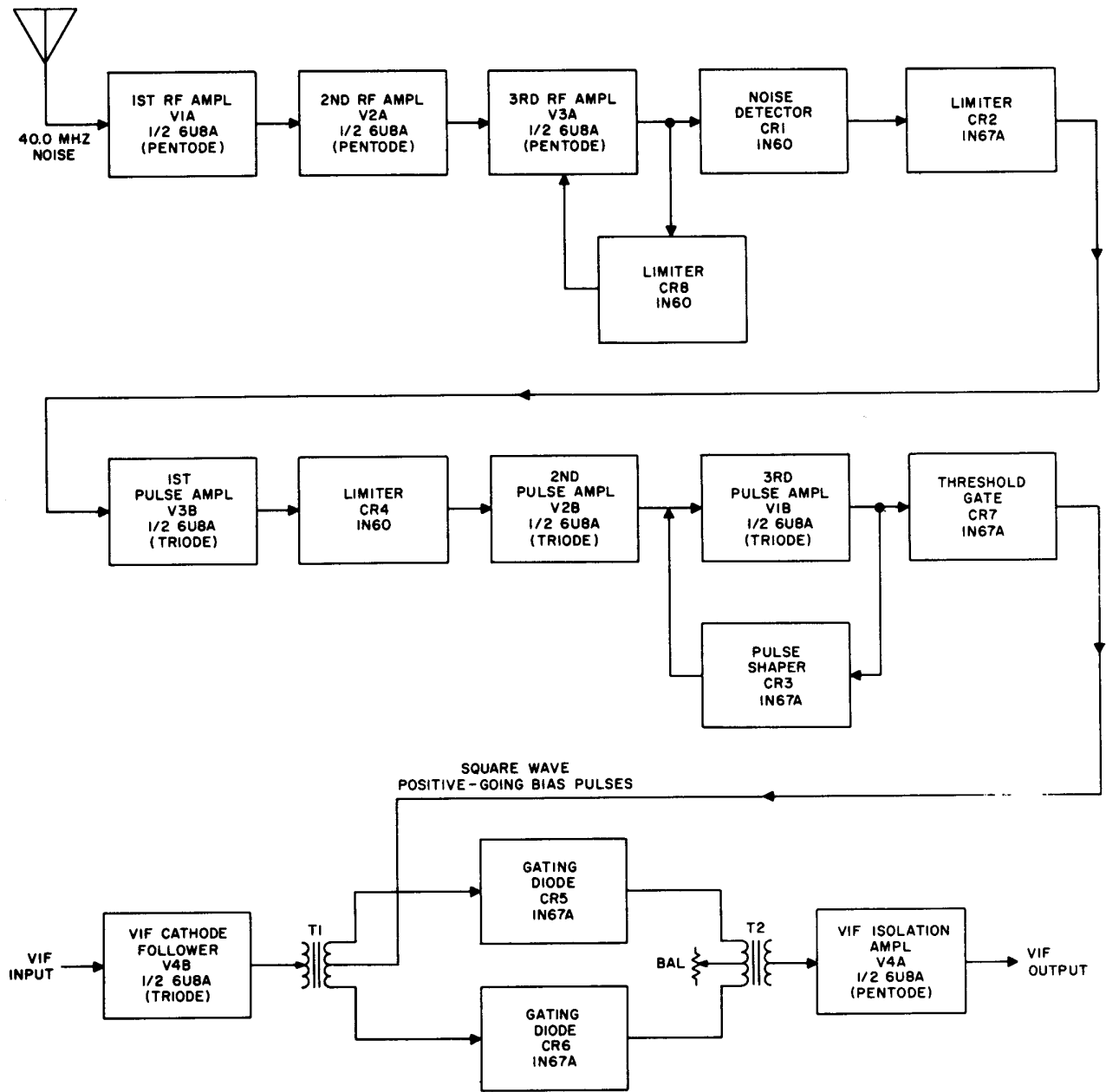

ELOD0011

Figure 6-2. Noise blanker, block diagram.

TM 11-5820-554-12
CHAPTER 7
POWER SUPPLIES

Section I. POWER SUPPLY PP-3990/FRC-93

7-1. Description

The PP-3990/FRC-93 (Collins PM-2) is a lightweight a.c. power supply. It is part of a complete high-frequency, single sideband station in a suitcase-sized carrying case. The complete station consists of the Collins KWM-2/2A, the PP-3990/ FRC-93 and Case, Electrical Equipment CY-6197/ GRC-159 (Collins CC-2) (fig. 7-1). The power supply converts 110- or 220-volt a.c. power to suitable voltage and current values for operation of the Collins KWM-2/2A. It clamps to the rear of the Collins KWM-2/2A so that both transceiver and power supply may be packed in the lightweight carrying case for portability. The assembled combination may be lifted together from the Collins CC-2, set on a desk or table (connected to an

a.c. power source, suitable antenna, microphone, and key), and operated as a portable station. A small speaker is included in this power supply. Adequate space is provided in the Collins CC-2 for small accessories.

7-2. Tabulated Data

Input requirements	110 or 220 volts, 50 to 400 Hz, 4 or 2 amperes.
Output (nominal): Heater power	6.0 to 6.3 volts a.c. at 11 amperes.
Low voltage B+ High voltage B+	275 volts at 175 ma. 260 volts at 210 ma. 700 volts at 230 ma (key down intermittent).
Bias voltage	-50 to -90 volts, no current requirements.

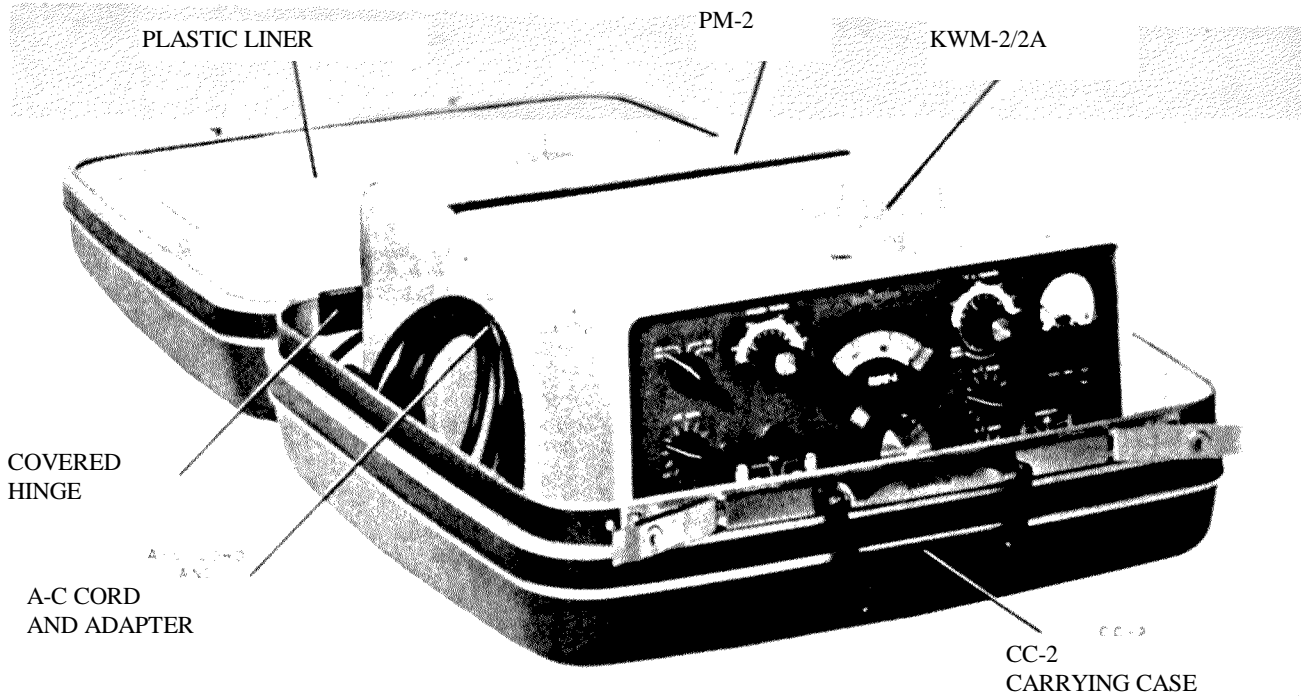
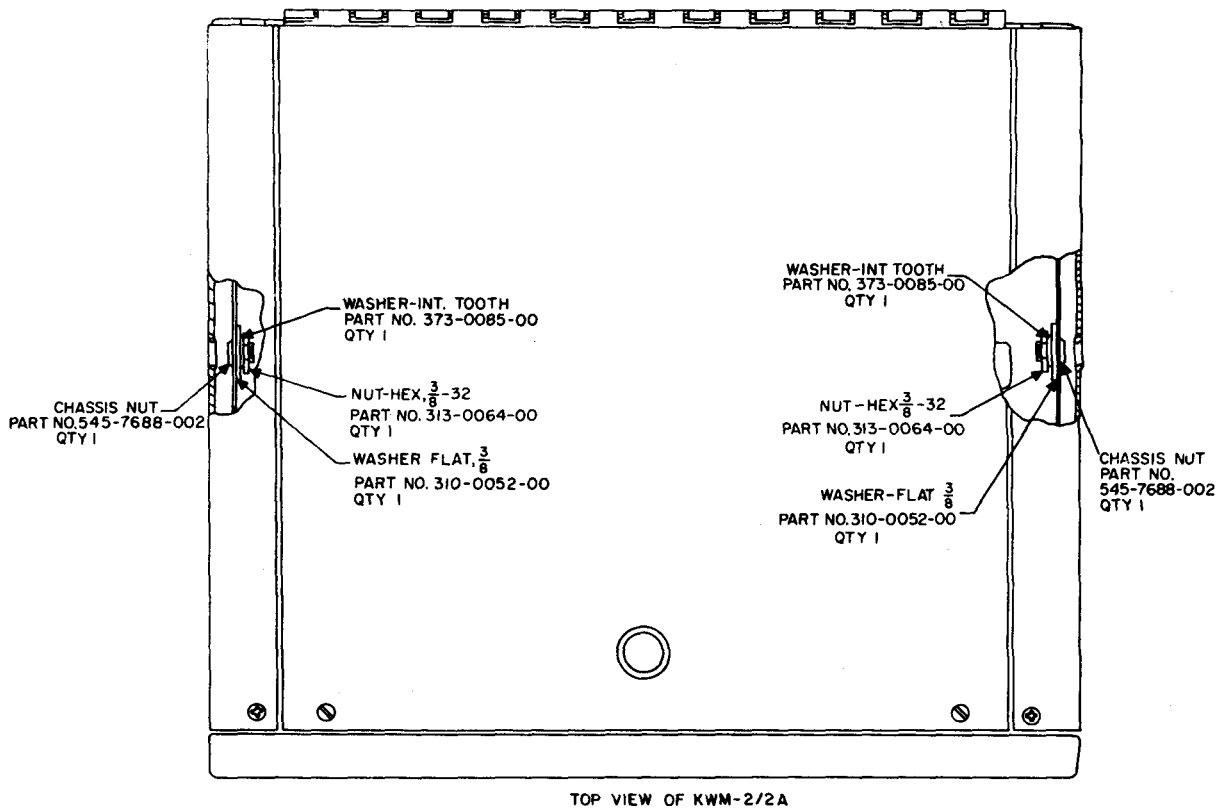

Figure 7-1. PP-3990/FRC-93 packed in (Collins CC-2) carrying case

TM 11-5820-554-12

7-3. Items Comprising Power Supply PP-3990/FRC-93

NSN	Item	Qty	Dimension } (in.)			Weight (lb)
			Height	Depth	Width	
5820-00-985-8171	Power Supply PP-3990/FRC-93 (Collins PM-2)	1	7 ¾	4	14 ¾	13 ½
5920-00-281-0210	Fuse, 4-ampere	1				
5920-00-474-6125	Fuse, 2-ampere	1				
5935-00-892-9148	Line cord adapter	1				
5995-00-951-0026	Jumper cord	2				
5355-00-971-9302	Pinned knob	2				
5340-00-975-5763	Chassis nut	2				
5310-00-821-8203	Flat washer	2				
5310-00-595-7154	Lockwasher	2				
5310-00-275-5147	Hexagonal nut	2				
	Right-angle cable assembly	6				



NOTES:

1. REMOVE CHASSIS FROM CABINET.
2. INSTALL THE CHASSIS NUTS AND STIFFENER PADS IN THE FLAT SIDED HOLES IN THE SIDE WALLS OF THE CHASSIS. USE THE 3/8-32 HEX NUTS AND THE INTERNAL TOOTH WASHERS FOR MOUNTING HARDWARE, AS SHOWN IN THE TOP VIEW.
3. REASSEMBLE CHASSIS INTO CABINET.

ELOD0013

Figure 7-2. Hardware installation diagram.

7-4. Installation

If the Collins KWM-2/2A has been fitted for use with Collins 351D-2, no changes are necessary for use with the PP-3990/FRC-93. The guide rails used with the Collins 351D-2 will not interfere with the PP-

3990/FRC-93 slide bars, and are not required for use with this power supply. If the Collins KWM-2/2A is not already fitted for such use, proceed as follows:

- a. Remove the Collins KWM-2/2A from its case.

TM 11-5820-554-12

b. Install the two large chassis nuts in the holes of the Collins KWM-2/2A chassis side walls (fig. 7-2 and 7-3).

c. With the Collins KWM-2/2A and PP-3990/FRC93 positioned (fig. 7-4), make the necessary phone jack connections. Use the end of the cable with the right-angle connectors at the Collins KWM-2/ 2A connections. Run the shielded cables down through the cord channels in the mating face of the PP-3990/FRC-93 and underneath the power supply. Power cables for Control, Radio Set C7515/FRC-93 (Collins 312B-5) may be run through the large holes in the front and back sides of the PP-3990/FRC-93.

d. Push the PP-3990/FRC-93 and the Collins KWM-2/2A together, and tighten the thumbscrews in the chassis nuts to hold the two together. Be sure power plug P2 mates correctly with the corresponding jack in the Collins KWM-2/2A. (Fig. 7-5). shows the complete assembly.

CAUTION

When using an extension cable such as the Collins 440F-1, Collins KWM-2/2A may be damaged unless the key is prop

erly aligned on the extension plug with the shallow keyway in power connector P2. Before connecting to the a.c. line and operating the combination, be sure the LINE VOLT SELECTOR SWITCH of the PP-3990/FRC-93 is set to the proper position for the a.c. power source which will be used. If the switch is set for 110-volt operation and the power supply is operated from a 220-volt source, damaging high voltages may be developed before the fuse blows.

e. To remove the PP-3990/FRC-93 from its case for access to the LINE VOLT SELECTOR SWITCH, remove the two Phillips-head screws from the rear (fuse side). Pull the PP-3990/FRC-93 from its case and check the LINE VOLT SELECTOR SWITCH to make sure it is set for the line voltage which will be used. Replace the power supply in its case, and reassemble to the Collins KWM-2/2A.

f. Plug the line cord connector into the a.c. outlet. The round pin of the a.c. connector is the ground connection. If the a.c. outlet is not fitted with a

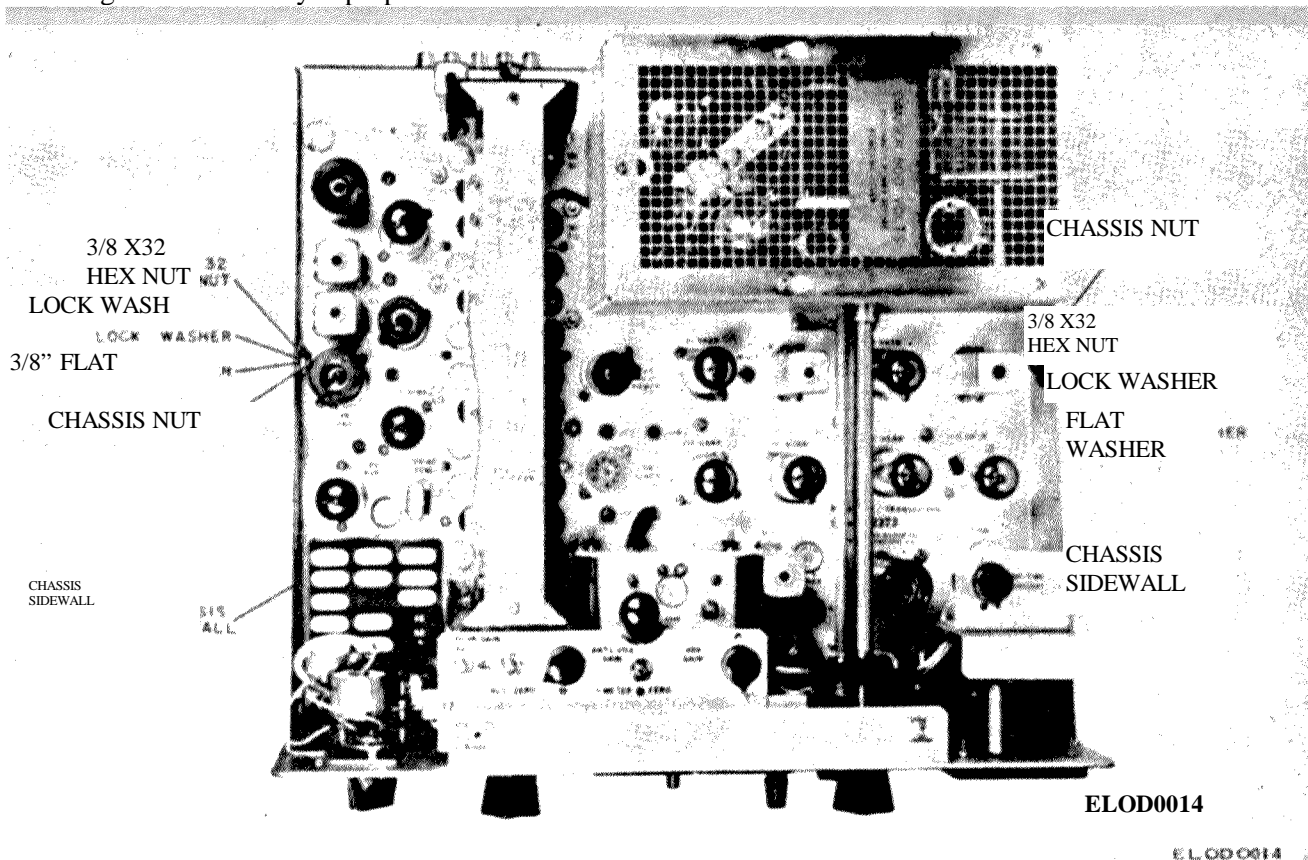

Figure 7-3. Installation of chassis nuts.

TM 11-5820-554-12

mating-type connector, use the adapter furnished, and ground the green wire. It is desirable to make a ground connection to the PP-3990/FRC-93KWM-2/2A combination, and the three-wire a.c. cord offers the most convenient arrangement.

g. Set the Collins KWM-2/2A MIC GAIN control fully counterclockwise until the switch clicks. Set the OFF-ON-NB-CAL switch to ON. Set the meter switch to PLATE and the EMISSION switch to LOCK. The transceiver is in receive condition during warm-up, so the meter will read full scale until the filaments reach operating temperature. This is normal S-meter action. When the S-meter falls back to zero, the circuits will have switched to transmit condition and the meter will indicate plate current at approximately 40 ma. If plate current is other than 40 ma, adjust BIAS ADJUST potentiometer R8 at the rear (fuse side) of the PP-3990/FRC-93 to set plate current to 40 ma. This setting is the proper idling current value for the Collins KWM-2/2A power amplifier tubes for linear operation. The PP-3990/FRC-93-KWM-2/2A is now ready for use.

7-5. Operation

CAUTION

Be certain the 110/220 LINE VOLT SELECTOR SWITCH on the PP-3990/FRC

93 is set to the proper position before plugging in the a.c. source. It is fused for 4-ampere primary current on 110-volt a.c. and for 2-ampere primary current on 220-volt a.c. If the switch is set to the 110-volt position and the power supply is operated from a 220-volt a.c. source, damaging high voltages may be developed before the fuse blows.

a. Do not operate the power supply and transceiver inside the carrying case with the cover closed. Be sure adequate ventilation is provided for the heat generating components of the equipment. The output is adequate for maximum KWM-2/2A ratings in LOCK key under intermittent conditions. DO NOT operate in LOCK key or TUNE position under continuous key down conditions.

b. No other operating procedures are required. Operation of the power supply is controlled from the switches and relays in the Collins KWM-2/2A.

7-6. Operator's and Organizational Maintenance

Operator's maintenance instructions are covered in paragraph 7-26 and 7-27. Organizational maintenance instructions are covered in paragraph 7-28 and 7-29.

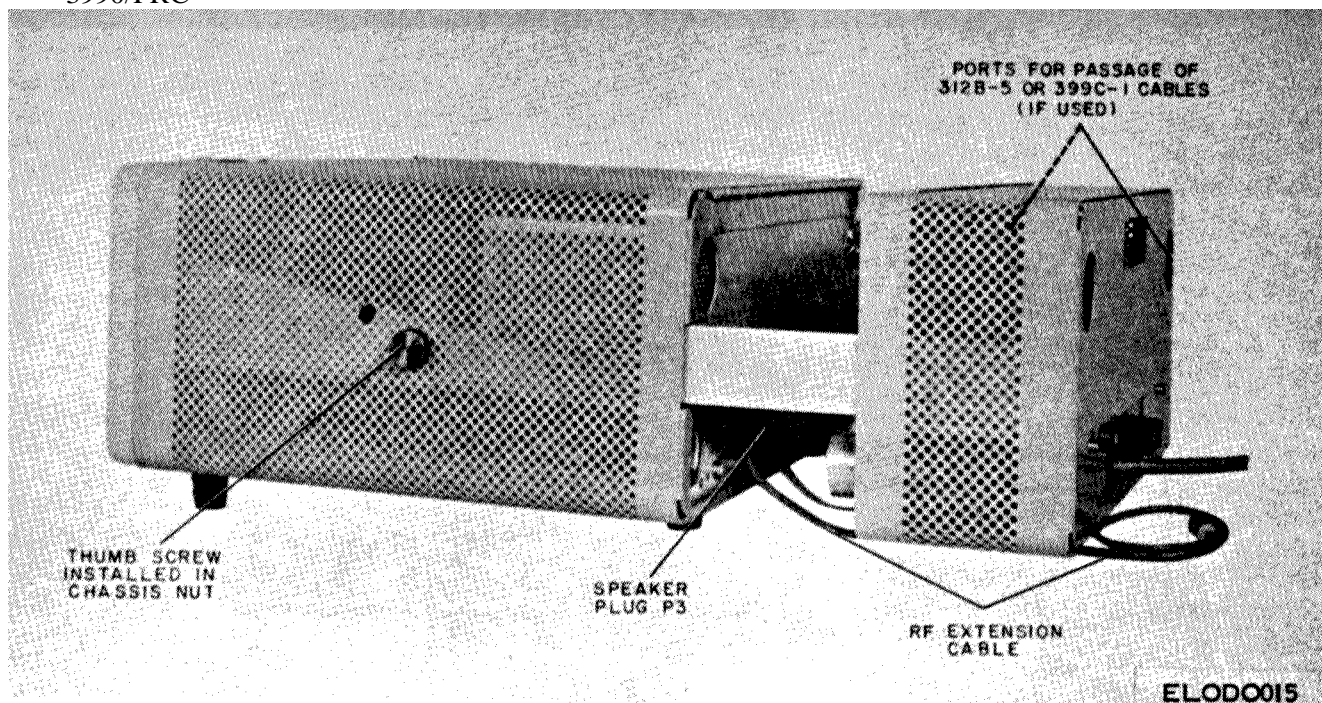
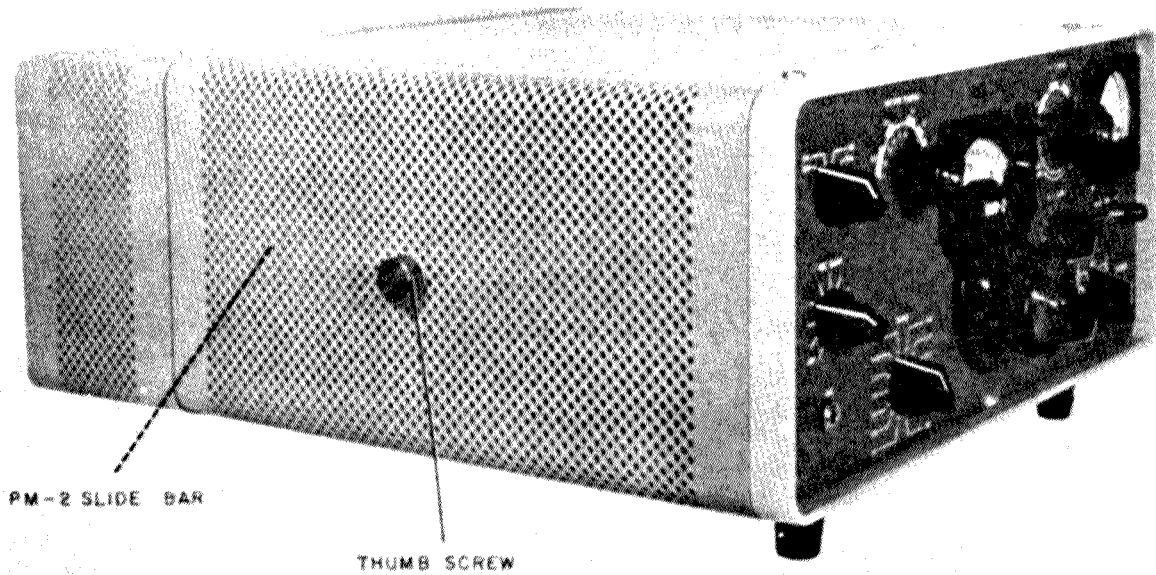

Figure 7-4. Phone jack assembly during assembly.



E LODO016

Figure 7-5. PP -3 990/FRC -93 assembled to Collins KWM-2/2A.

Section II. POWER SUPPLY PP-4151/FRC-93

7-7. Description (fig. 7-6).

Power Supply PP-4151/FRC-93 (Collins 516F-2) provides all operating voltages for the Collins KWM-2/2A. It operates from a 115- or 230-volt, 50- 400-Hz power source to provide high voltage d.c., low voltage d.c., variable d.c. bias, and an a.c. filament supply that is connected to associated equipment by a 60-inch length of cable and terminated in an 11-pin female cable connector. This 11-pin female cable connector mates with a male power receptacle located on the Collins KWM-2/ 2A. As supplied, the PP -4 151/FRC-93 is wired for 115-volt operation. It is equipped with a ventilated cabinet having four rubber feet for table mounting. To apply power to the PP-4151/FRC-93, two pins on the 11-pin female cable connector (P2-7 and P2-7 are connected together in the external

equipment. In the Collins KWM-2/2A, this function is provided whenever the transceiver OFF-ON-NB-CAL switch is set to ON, NB, or CAL

7-8. Tabulated Data

Input requirements	115 or 230 volts, 50 to 400 Hz, 2 or 4 amperes. (Remove capacitor C1 when using a line frequency higher than 60Hz.)
Output (nominal):	
Heater power	6.3 volts at 10.0 amperes.
Low voltage B	300 volts d.c. at 170 ma 285 volts d.c. at 210 ma.
High voltage B+	940 volts d.c. at 55 ma. 820 volts d.c. at 230 ma
Bias voltage	-55 to -88 volts, no current requirement
Ambient temperature range	0 to +50°C.

7-9. Items Comprising Power Supply PP-41 51 /FRC-93

NSN	Item	Dimensions			Weight (lb)
		Height	Depth	Width	
5820-00-034-4239	Power Supply PP-4151/FRC-93 (Collins 516F-2)	7 3/4	9 7/8	11 1/2	30

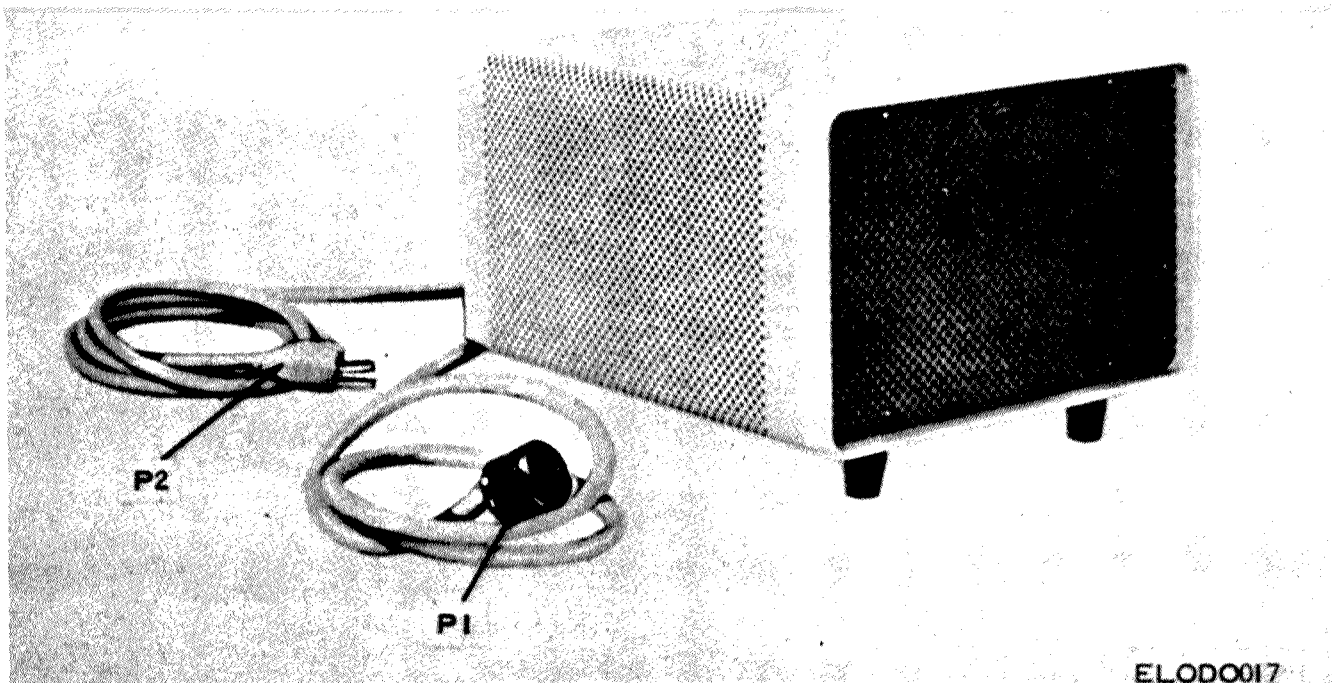

Figure 7-6. Power Supply PP-4151/FRC -93 S. location of power plugs P1 and P2.

7-10. Installation

CAUTION

Possible damage to associated equipment can result if the keyway of power plug P1 is not aligned with the keyway of its associated mating connector. Always disconnect a.c. power plug P2 when joining P1 with its respective mating connector. Always check for keyway alignment before applying power, and be sure power transformer primaries are correctly connected for the line voltage to be used.

- a. Plug connector P1 into its mating connector.
- b. Plug line connector P2 into an a.c. outlet. If the a.c. outlet is not fitted with a mating connector, use the adapter furnished, and ground the green wire.
- c. Turn on the associated equipment and adjust BIAS ADJUST potentiometer R9 (accessible at the rear of the PP -93 4151/FRW93 without the cover removed) to the desired bias level. The PP -4151/FRC-93 is now ready for use. When using the Collins KWM-2/2A, proceed as follows:

- (1) Set the MIC GAIN control fully counterclockwise.
- (2) Set the EMISSION switch to LOCK.
- (3) Set the meter switch to PA PLATE.
- (4) Set the OFF-ON-NB-CAL switch to ON.

(5) After a 2-minute warm-up period, the no signal pa plate current, as monitored on the meter, should be approximately 40 ma. If it is not 40 ma, adjust BIAS ADJUST potentiometer R9 at the rear of the PP-4151/FRC-93 until a 40-ma reading is obtained.

NOTE

When using a line frequency higher than 60 Hz, remove capacitor C1. Always make sure adequate ventilation is provided for the heat generating components of the equipment.

7-11. Operation

Operation of the PP 4151/FRC-93 is controlled completely by switches and relays in the associated equipment. The only adjustment provided in the PP 4151/FRC-93 is the -55- to -80-volt d.c. variable bias supply. This is a screwdriver adjustment accessible at the rear of the unit. The bias adjustment will depend on the type of equipment used with the PP-4151/FRC-93.

7-12. Operator's and Organizational Maintenance Instructions

Operator's maintenance instructions are covered in paragraph 7-26 and 7-27. Organizational maintenance instructions are covered in paragraph 7-28 and 7-29.

Section III. POWER SUPPLY PP-4765/GRC-1 59(V)

7-13. Description

Power Supply PP - 4765/GRC-159(V) (Collins 516E2) converts d.c. energy from the automobile storage battery (negative terminal ground) to B+ and bias voltages necessary for operation of mobile amateur equipment such as the Collins KWM-2/ 2A. The PP 765/GRC-159(V) may be used in a car, boat, or plane having a 28-volt power system.

7-14. Tabulated Data

Input requirements:

- Voltage..... 24 to 30 volts, 28 volts nominal.
- Current..... Up to 15 amp

Outputs (nominal):

- Heater voltage 24 volts, 2 1/2 amp.
- Bias voltage..... -50 to -80 volts (adjustable).
- Low voltage 265 volts, 210 ma.
- High voltage 750 volts, 185 ma.

Output regulation:

- Heater voltage 24 volts, 2 1/2 amp.
- Bias voltage -50 to -80 volts (adjustable).

Low voltage	265 volts , 210 ma.
High voltage	750 volts,185 ma.
Output regulation:	
Low voltage	290 volts maximum at 170 ma.
High voltage	860 volts maximum at 55 ma. 690 volts minimum at 250 ma.
Ripple present on outputs:	
Filament	Less than 2.5 volts peak to peak.
Bias	Less than 0.5 volt peak to peak.
Low voltage	Less than 0.2 volt peak to peak.
High voltage	Less than 10 volts peak to peak.
Efficiency	Approximately 80%.
Operating temperature	-30° C. to +60° C
Humidity	0 to 90% at 50° C. for 48 hours.

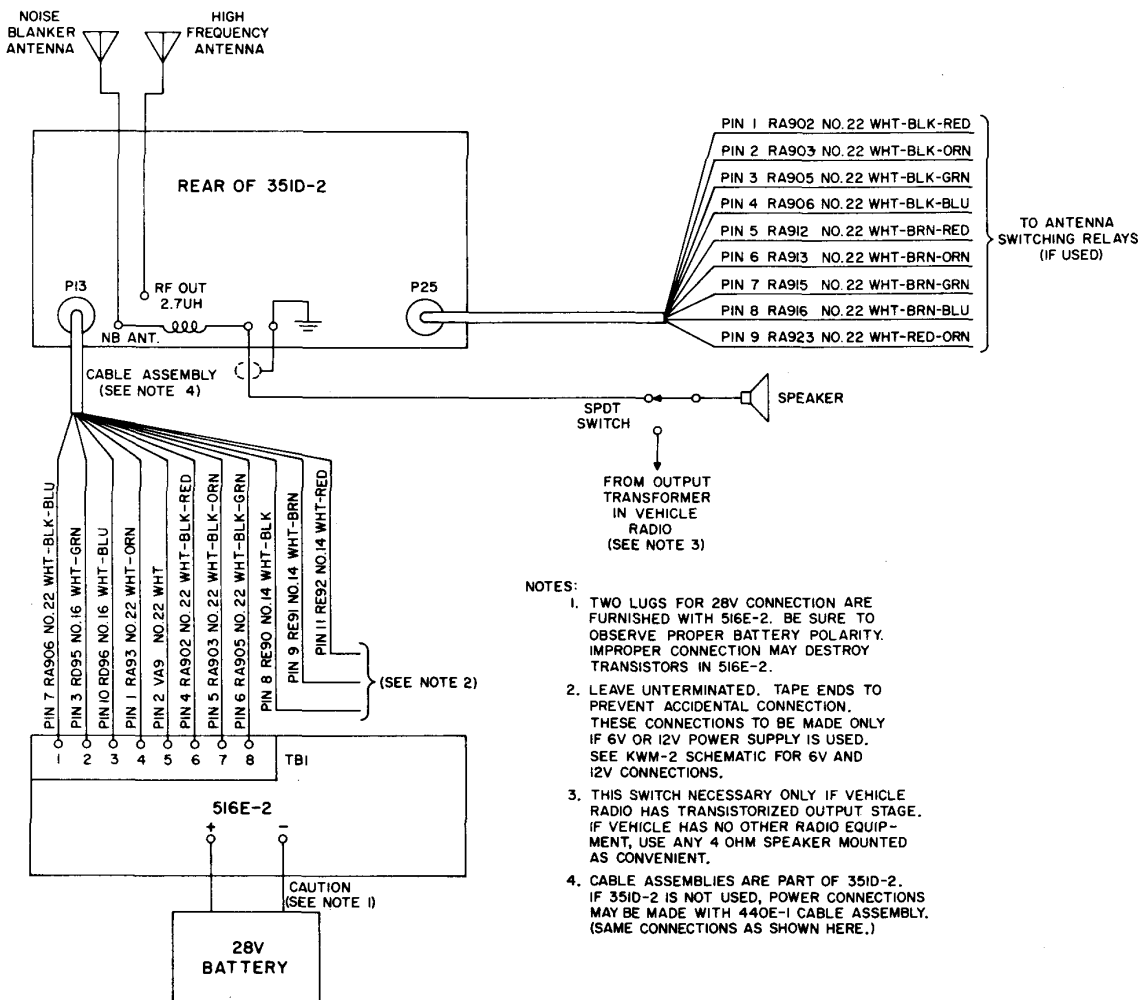

- NOTES:
1. TWO LUGS FOR 28V CONNECTION ARE FURNISHED WITH 516E-2. BE SURE TO OBSERVE PROPER BATTERY POLARITY. IMPROPER CONNECTION MAY DESTROY TRANSISTORS IN 516E-2.
 2. LEAVE UNTERMINATED. TAPE ENDS TO PREVENT ACCIDENTAL CONNECTION. THESE CONNECTIONS TO BE MADE ONLY IF 6V OR 12V POWER SUPPLY IS USED. SEE KWM-2 SCHEMATIC FOR 6V AND 12V CONNECTIONS.
 3. THIS SWITCH NECESSARY ONLY IF VEHICLE RADIO HAS TRANSISTORIZED OUTPUT STAGE. IF VEHICLE HAS NO OTHER RADIO EQUIPMENT, USE ANY 4 OHM SPEAKER MOUNTED AS CONVENIENT.
 4. CABLE ASSEMBLIES ARE PART OF 351D-2. IF 351D-2 IS NOT USED, POWER CONNECTIONS MAY BE MADE WITH 440E-1 CABLE ASSEMBLY. (SAME CONNECTIONS AS SHOWN HERE.)

Figure 7-7. Interconnections to Collins KWM-2/2A.

7-15. Items Comprising Power Supply PP -4 765/GRC-1 59(V)

NSN	Item	Dimensions			Weight (lb)
		Height	Depth	Width	
6130 00-926-7805	Power Supply PP -4 765/GRC-159(V) 24-volt d.c. input (Collins 516E-2)	5 3/4	7 3/4	11 3/8	12

7-16. Installation (fig. 7-7)

a. Select a location in the vehicle, boat, or aircraft for mounting the PP-4765/GRC-159(V) where it will be cool, clean, and dry as possible. Location under the seat or on the passenger side of fire wall is usually satisfactory. DO NOT mount it in the engine compartment.

b.. Determine the necessary length of power cable to connect the power supply to the equipment. If the power supply is to supply voltages to the Collins KWM-2/2A and the Collins 351D-2 is used, cut the required length of cable from that furnished with the mount. If the Collins 3511) 2 is not used, use a power connecting cable such as Collins 440E-1. Wire color code and pin-terminal interconnecting information is the same for the Collins 440E-1 as for the power cable furnished as part of the Collins 351D-2. Other connections to the Collins KWM-2/2A may be made as shown in figures 3-1 through 3-6.

c. Remove the cover from the PP-4765/GRC-159(V) power supply terminal board, and make connections to the terminal board (fig. 7-7).

CAUTION

1. DO NOT connect the PP-4765/GRC-159(V) power supply to a 28-volt d.c. source having transient voltages in excess of 50 volts. To do so will destroy the switching transistors.
2. Be sure to observe proper polarity of the battery when making connections to the 24-volt terminals of the power supply DO NOT connect the PP-4765/GRC-159(V) to a system which has a positive ground unless the power supply has been modi-

fied to accept this change of polarity. Wrong polarity of connections will destroy all four transistors in the power supply. As an added precaution, remove the fuses before making connections to the terminal board. They may be replaced after all connections have been made and checked. After the power cable and the 28-volt leads are connected, replace the terminal board cover.

d. Before use with the Collins KWM-2/2A, adjust the bias voltage as follows:

- (1) Set the MIC GAIN control fully counter-clockwise
- (2) Set the EMISSION switch to LOCK.
- (3) Set the meter switch to PA PLATE.
- (4) Set the OFF-ON-NB-CAL switch on.
- (5) After a 2-minute warm-up period, the no signal plate current, as monitored on the meter, should be approximately 40 ma. If it is not 40 ma, adjust BIAS ADJUST potentiometer R19 on the power supply until a 40 -ma reading is obtained.

7-17. Operation

Operation of the power supply is controlled from switches and relays in the equipment for which the PP 4765/GRC-159(V) supplies power. No other operating procedures are required.

7-18. Operator's and Organizational Maintenance Instructions

Operator's maintenance instructions are covered in paragraph 7-26 and 7-27. Organizational maintenance instructions are covered in paragraph 7-28 and 7-29.

Section IV. POWER SUPPLY 1 2-VOLT D.C. INPUT

7-19. Description

The Collins MP-1 converts 12-volt d.c. energy from an automobile storage battery to B+ and bias voltages necessary for operation of mobile amateur equipment such as the Collins KWM-2/2A. The Collins MP-1 can be used in car, boat, or plane having a 12-volt d.c. power system. If the Collins 351-2 mobile mount is

used, it includes a power cable for connection between the Collins KWM-2/2A and the Collins 351-2 combination and the Collins MP-1 supply. If the Collins 351-2 is not used, use the Collins 440E-1 cable to connect the Collins MP-1 to the Collins KWM-2/2A.

TM 11-5820-554-12

7-20. Tabulated Data

Input requirements:

Voltage..... 11 to 16 volts nominal.
 Current Up to 30 amperes.

Outputs (nominal)

Heater..... 12 volts, 6.0 amperes.
 Bias..... -50 to -80 volts
 adjustable (47,000 ohm
 load).
 Low B+ 265 volts, 210 ma.
 High B + 750 volts, 185 ma.

Output regulation:

Low voltage..... 290 volts maximum at 170 ma.
 265 volts minimum at 210 amperes.
 High voltage..... 870 volts maximum at 55 ma.
 695 volts minimum at 230 ma.

Ripple present on outputs:

Bias Less than 0.35 volt peak to peak.
 Low B+ Less than 0.2 volt peak to peak.
 High B+ Less than 10 volts peak to peak.

Efficiency Approximately 80%.

Operating temperature -30° C. to +60° C.

Humidity 0 to 95% at +50° C. for 48 hours

7-21. Items Comprising Power Supply 12-Volt D.c. Input

NSN	Item	Qty	Dimensions			Weight (lb)
			Height	Depth	Width	
5820 00-034 4233	Power supply 12-volt d.c. input (Collins MP-1)	1	3 3/4	5 1/4	11	7 1/2
	No. 10 solder lugs	5				
	No. 6 solder lugs	5				
	Cable clamp	1				
	Sheet metal screws No. 12 x 1	4				
	30-ampere fuses	1				

7-22. Installation

a. Select a location in the car for mounting the (Collins MP-1 where it will be cool, clean, and dry as possible. Location under the seat or on the passenger side of the fire wall is satisfactory. The sheet-metal screws supplied require 5/32-inch mounting holes. The shortest possible length of line to the battery is desirable. Under full load, the Collins MP-1 draws approximately 25 amperes. At these current levels, voltage drop through unnecessarily long leads can be appreciable. Coupled with normal variations in primary voltage due to fluctuations in generator charging rate, this will have an adverse effect upon the Collins MP-1 output voltage regulation.

b. Determine the necessary length of power cable to connect the Collins MP-1 to the equipment which it is to operate. If the power supply is to provide voltages for the Collins KWM-2/2A and the Collins 351D-2, cut the required length of cable from the cable furnished with the mount. Attach the necessary solder lugs to the loose end of the cable for connection to the terminal board of the Collins MP-1. Five No. 6 lugs are supplied with the power supply (para 7-21). Figure 7-8 shows proper power supply interconnections to the Collins KWM-2/2A and 351D-2 combinations.

c. Remove the cover from the Collins MP-1, and make connections to the terminal board (fig. 7-8). Two lengths of No. 10 wire are furnished with the Collins 351D-2 for connection between the power supply and battery. Cut these wires to the required length, and fit

with No. 10 lugs (furnished). If the Collins 351D-2 is not used, procure the necessary wire and connect the car power supply to the studs on the Collins MP-1. If necessary, the cable may be secured by one of the mounting screws and the cable clamp furnished.

CAUTION

The Collins MP-1 is connected for negative ground when shipped from the factory. Observe proper polarity or the Collins MP-1 will not operate. See figure 7 for stud strapping details. Be sure to reverse the yellow and blue connections to stud-mounted diode CR1 if positive ground is to be used.

7-23. Initial Checks

Turn the Collins KWM-2/2A MIC GAIN control fully counterclockwise (off) until the switch clicks. Set the OFF-ON-NB-CAL switch to ON. Set the meter switch to PLATE and the EMISSION switch to LOCK. The transceiver is in the receive condition during warm-up, so the meter will read full scale until the filaments reach operating temperature. This is normal S-meter action. When the S-meter falls back to a lower value, the circuits will have switched to transmit condition, and the meter will indicate pa plate current. Read the no-signal plate current. It should be approximately 40 ma. If the plate current is other than 40 ma, adjust bias adjust potentiometer R11 on the power supply printed circuit board to set the plate cur

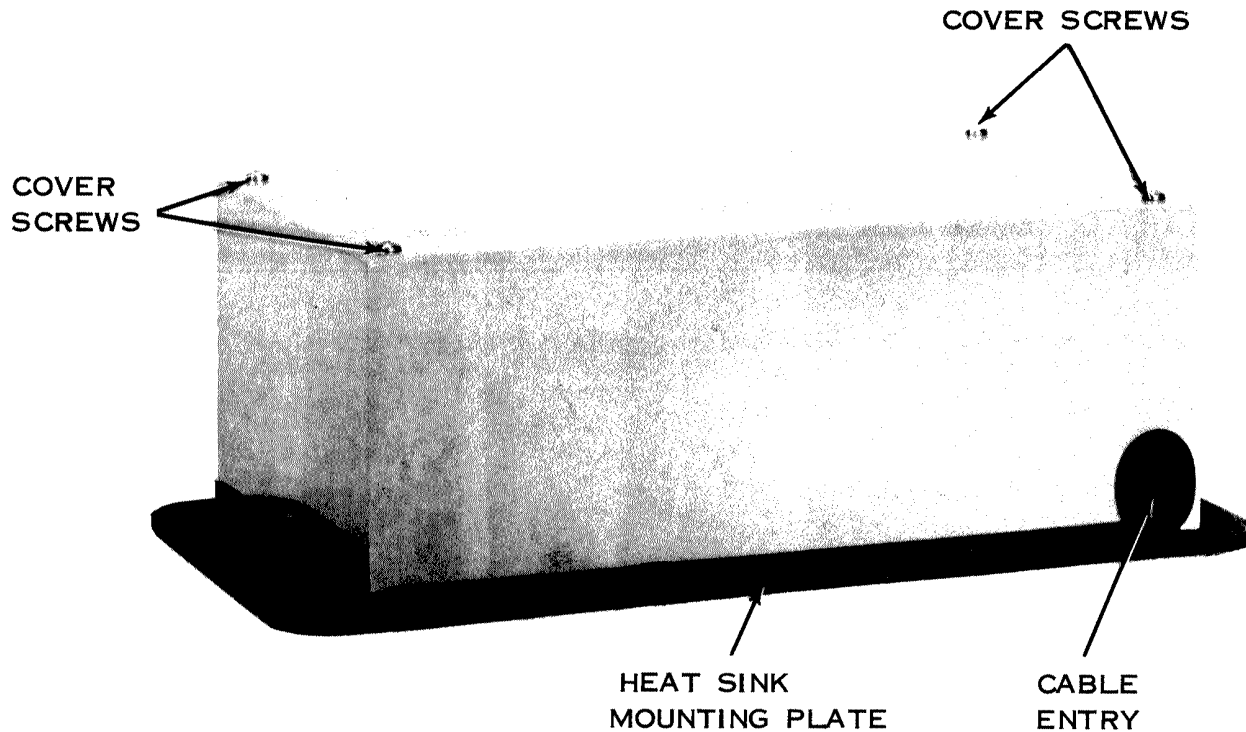

ELODO020

Figure 7-9. Mobile power supply (Collins MP-1).

Section V. OPERATOR'S MAINTENANCE INSTRUCTIONS

7-26. General

Paragraphs 3-19, 3-20, and 3-21 covered operator's maintenance. Cleaning is covered in paragraph 3-24.

7-27. Operator's Daily Preventive Maintenance Checks and Services Chart for Power Supplies PP-3990/FRC-93, PP-4151/FRC-93, PP-4765/GRC-159(V), and Collins MP-1

Item No.	Interval					Item to be inspected	Procedures	Equipment is not ready/ available if:
	B	D	A	W	M			
•						Power supply loading	Observe power supply voltage levels during transmitter modulation. Voltages should not swing with modulation.	Power supply stability results in faulty sideband generation. Signal garbled enough to destroy intelligence.

Section VI. ORGANIZATIONAL MAINTENANCE INSTRUCTIONS

7-28. General

Paragraph 3-25, 3-26, and 3-27 cover organizational maintenance. Touchup painting is covered in paragraph 3-29.

TM 11-5820-554-12

7-29. Organizational Preventive Maintenance Checks and Services Chart for Power Supplies PP-3990/FRC-93, PP-4151/FRC-93, PP-4765/GRC-159(V), and Collins MP-1

Item No.	W-Weekly			M-Monthly	Q-Quarterly
	Interval				
	W	M	Q	Item to be inspected	Procedures
		•		Regulator circuits	Modulate transceiver with test signals. Insure that power supply voltages are stable.

Change 6 7-12

REGULATOR, VOLTAGE CN-1146/FRC-93

Section I. INTRODUCTION

8-1. Description

Regulator, Voltage, CN-1146/FRC-93 (Solar Electric 36-189) is an autotransformer. The output voltage is regulated by a solid-state electronic control circuit. The control circuit senses the out-put voltage, compares it with an established reference voltage, and by indirectly changing the flux density in the area of the opposing transformer, restores the output voltage to the predesignated level. The control circuit requires only a fraction of the full load current, thus maintaining high efficiency and longevity of the electronic components at all load levels. The regulator does not contain any relays, switches, moving contacts, solenoids, bearings, drive motors, servos, handcranks, fuses, electron tubes, or any moving parts.

8-2. Ratings

Input voltage	60 to 150 volts a.c. single-phase, 48 to 63 Hz
Load	1 KVA maximum, 225 VA minimum at maximum power factor.
Output	115 volts a.c. ±5% for any combination of line, load, or frequency within the specified limits.
Response time	Correction begins within 10 milliseconds (ms) and is typically 90% complete in 200ms, and 100% complete in 400 ma.
Ambient temperature	0°C.to 550 C.
Altitude	Sea level to 6,000 feet for operation. Can be transported

Relative humidity up to due to by air at altitudes up to 40,000 feet. Will operate satisfactorily when subjected to relative humidity 80%, including condensation temperature changes.

8-3. Tabulated Data

Regulations	±5% for any condition of line,load, or frequency within the ratings of the unit.
Output voltage	115 volts a.c. (110 to 120 volts) for all variations in input voltage, frequency, or load within the specified limit.
Frequency	48 to 63 Hz.
Harmonic distortion	Less than 12% total.
Response time	200 to 400 ms depending on the severity of the ban. In all cases recovery begins in the first cycle.
Load	225 VA .8 PF lagging to 1 KVA .8 PF lagging to unity PF.
Overload	Momentary currents of several times rated current will not damage the regulator. Extended overloads will cause increased heating of the magnetics.
Watt efficiency	Better than 80% at full load, 115v, 60 Hz. Better than 70% at all line voltages, 60Hz, full load.

NOTE

Input circuits must be capable of carrying 30 amperes.

8-4. Items Comprising an Operable Regulator, Voltage CN-1 146/FRC-93

NSN	Item	Dimensions (in.)			Weight (lb)
		Height	Depth	Width	
6110-00-930-0400	Regulator, Voltage, CN-1146/FRC-93 (Solar Electric 36-189)	27	17	7 ¼	150

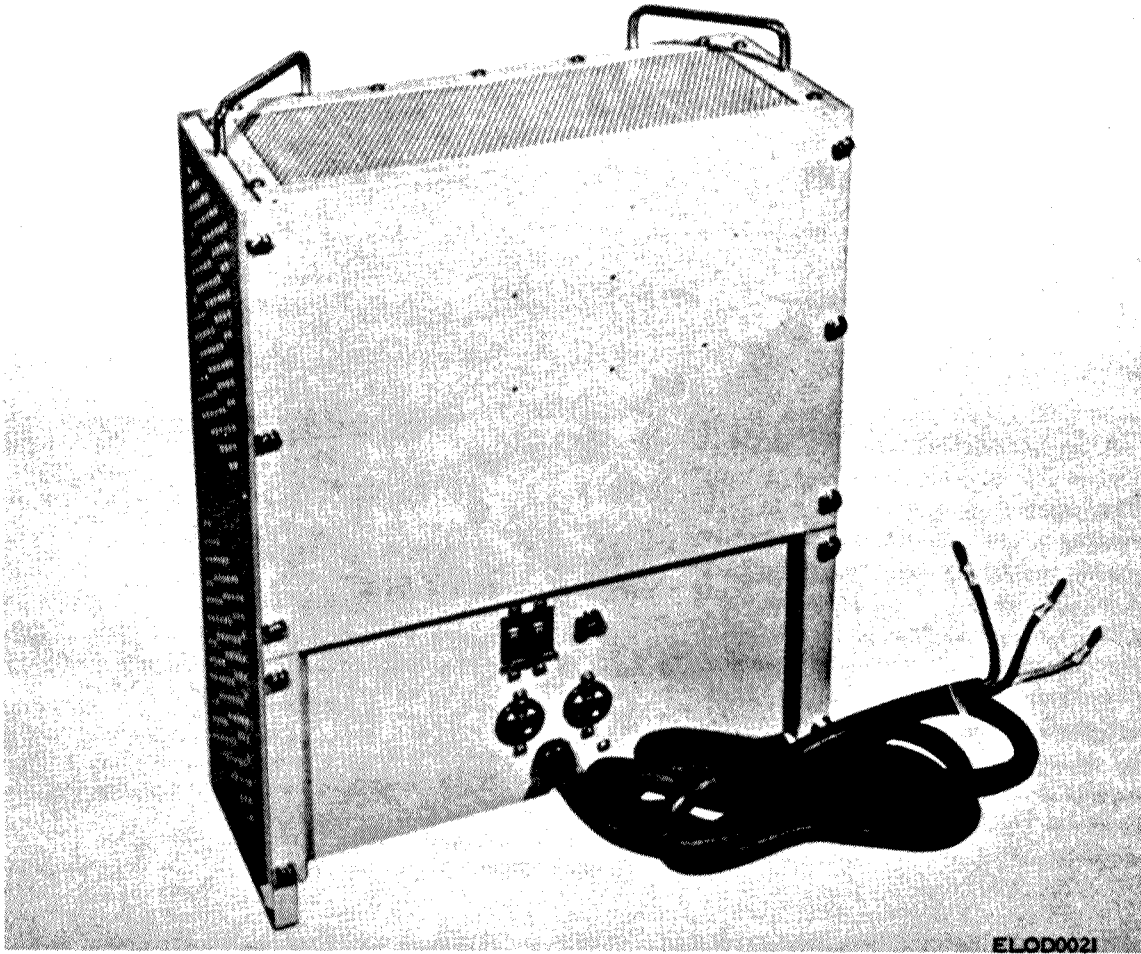
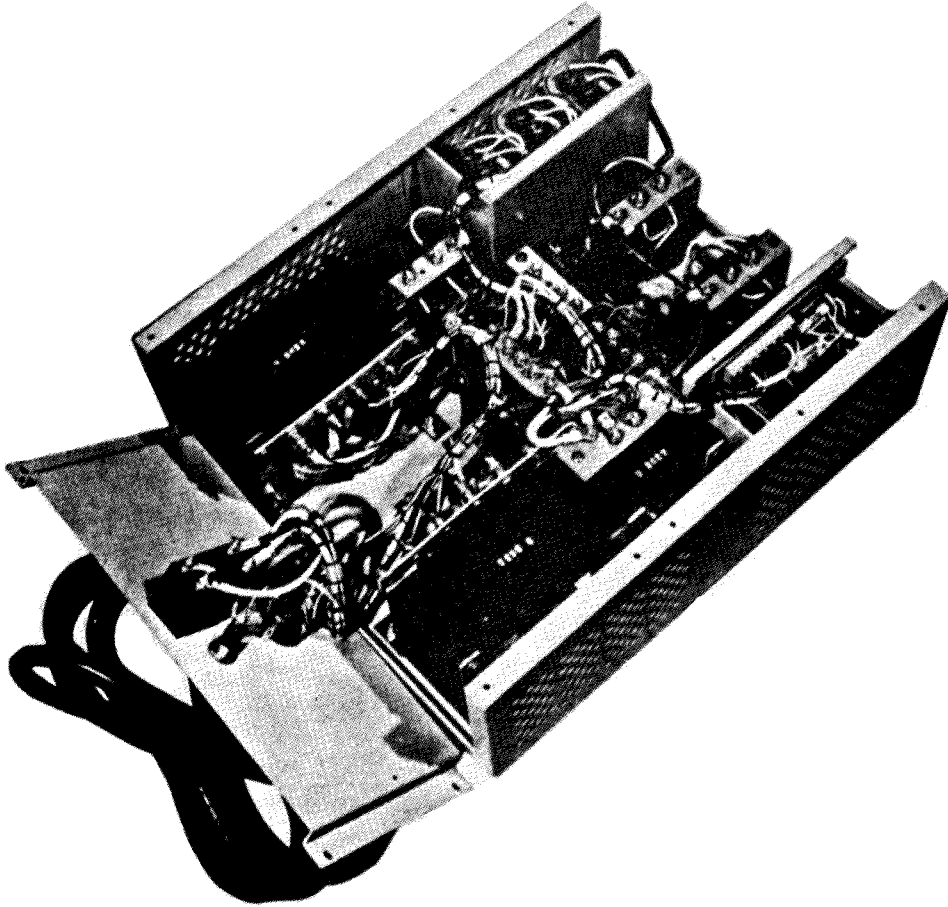

Figure 8-1. Regulator, Voltage, CN-1146/FRC-93, front view (inclosed).



ELOD0022

Figure 8-2. Regulator, Voltage, CN-1146/FRC-93, front view (cover removed)

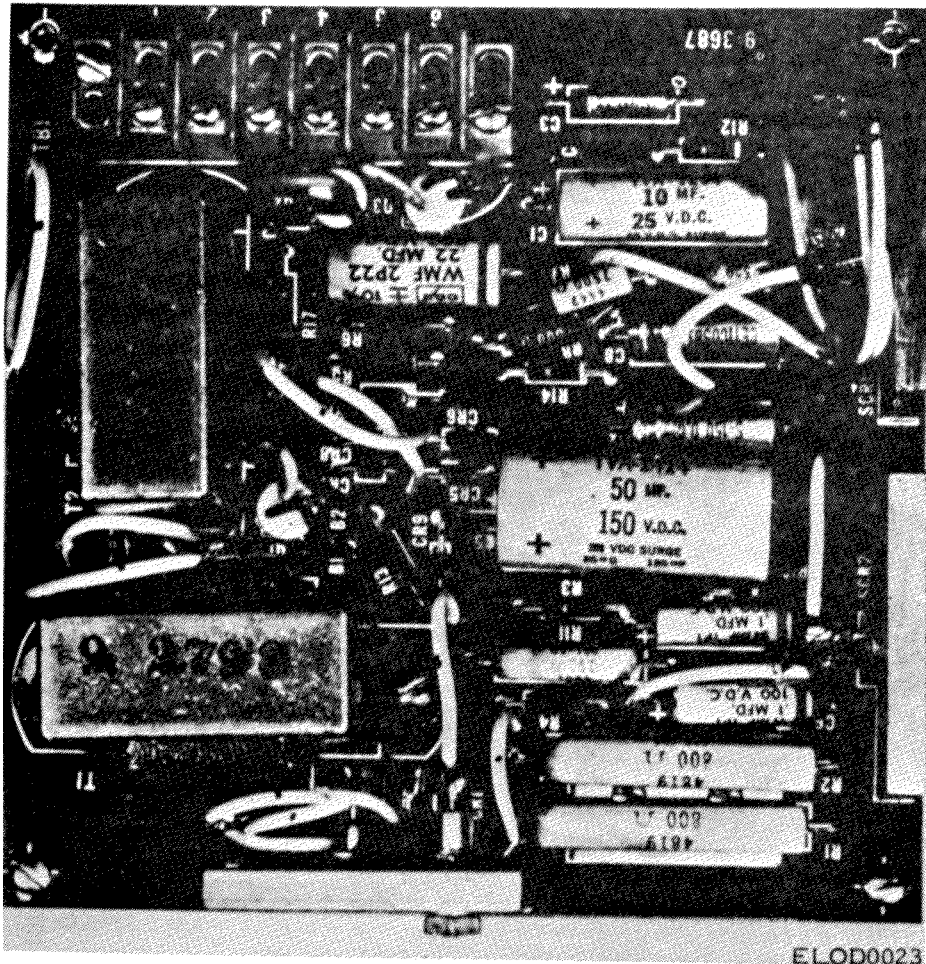

Figure 8-3. Control circuit board (removed and open to show detail).

Section II. INSTALLATION

8-5. Mechanical

The unit must be operated with the carrying handles up. The CN-1146/F RC-93 relies on natural convection cooling only, and this must be considered when mounting the unit. Mounting in a confined or poorly ventilated space should be avoided. Holes are provided in the bottom brackets for permanently mounting the unit.

8-6. Electrical

Connect the black and white leads of the input cable to a power source capable of delivering 30 amperes at a voltage between 60 and 150 volts from 48 to 63 Hz. The green lead on the input cable should be connected to ground. The load may be plugged into the receptacles on the regulator.

Section III. PRINCIPLES OF OPERATION

8-7. General (fig. 8-4)

The output voltage is regulated to ± 5 percent by the solatron autotransformer network in response to a signal applied to the magnetic amplifier control windings by the control amplifier. The control amplifier amplifies the difference between the output voltage signal from the feedback circuit and the reference source signal. This amplified difference voltage is applied to the control windings. The control amplifier is comprised of three main stages: transistor difference amplifier; unijunction transistor firing circuit; and silicon controlled rectifier (scr) power amplifier. Three internal harmonic filters reduce the harmonics in the output to less than 12 percent. The regulated d.c. supply provides operating voltages to the reference source, transistor difference amplifier, and unijunction transistor firing circuit.

8-8. Solatron Autotransformer Network

The solatron autotransformer network is a magnetic assembly which acts as a variable autotransformer. It is controlled by direct current and can either add to, or subtract from, the input voltage. It is comprised of an autotransformer, a linear reactor and a two-component saturable reactor. The load is connected to the output of the autotransformer. One side of the autotransformer is common to both the input power and output loads. The other side of the input line is connected to two taps on the autotransformer. One tap is a step-up which has the saturable reactors connected in series, the other tap is a stepdown and has the linear reactor connected in series. With no d.c. control current, power is applied through the linear reactor and stepdown tap. Increasing the d.c. in the saturable reactors increases the power drawn through them until maximum step-up is reached. In operation, the d.c. in the control windings is controlled by semiconductor circuitry.

8-9. Silicon Controlled Rectifier Circuit

The d.c. control current for the solatron autotransformer network is produced by a transformer and two scr's in a full wave center-tapped rectifier configuration. A silicon controlled rectifier is a four-layer, three-terminal, semiconductor device. It acts both as a rectifier (it carries current in one direction only) and as a latching switch (it will not conduct

current until it is signaled to do so by a pulse on its third terminal gate). It latches on, when the anode-to-cathode current exceeds a certain small value I_h , and turns off when the current falls below this value. When it is off, it will withstand full circuit voltages; when on, its voltage drop is about 1 volt. It will withstand circuit voltages in the reverse direction.

8-10. Unijunction Transistor Firing Circuit

This circuit supplies a pulse to get the scr's in response to a d.c. voltage signal from the difference amplifier. A unijunction transistor (ujt) is a single-junction, three-terminal, silicon semiconductor device.

8-11. Difference Amplifier

The difference amplifier is a two-transistor circuit. Its output is approximately proportional to the difference between its two inputs. Its two outputs are the reference voltage source and the signal voltage from the output voltage feedback circuit.

8-12. Reference Circuit

The reference circuit is comprised of a Zener diode and a resistor. The voltage developed across the Zener diode is very stable because the d.c. voltage supplied to this circuit is preregulated by the main d.c. supply regulator. The reference voltage

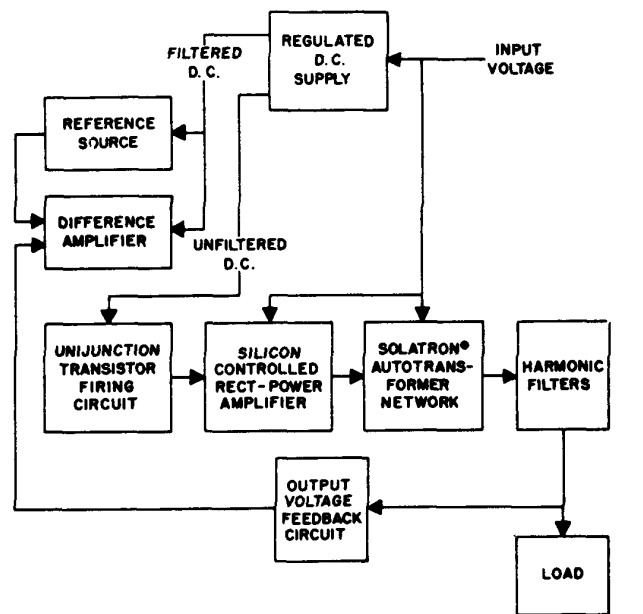

Figure 8-4. Regulator, Voltage , CN-1146/FRC -95, block diagram

EL0D0024

TM 1 1-5820-554-12

developed is connected to one input of the difference amplifier to supply a stable bias point.

8-13. Feedback Circuit

The feedback circuit supplies a d.c. signal voltage, proportional to the output voltage, to the difference amplifier. The voltage level of the feedback signal is adjusted by the potentiometer. This potentiometer is factory-adjusted to give nominal voltage, and should not require further adjustment.

8-14. D.C. Supply for Control Circuits

Unfiltered, regulated d.c. voltage is supplied to

the ujt firing circuit. Filtered, regulated d.c. voltage is supplied to the difference amplifier and reference circuit.

8-15. Harmonic Filter Network

The harmonic distortion in the solatron autotransformer network output is reduced to less than 12 percent by the harmonic filter network. Its output is applied to the load and to the output voltage feedback circuit.

Section IV. OPERATOR'S MAINTENANCE INSTRUCTIONS

8-16. General

Paragraphs 3-19 through 3-22 cover operator's maintenance duties. Paragraph 3-24 covers cleaning.

8-17. Operator's Preventive Maintenance Checks and Service Chart for Regulator, Voltage, CN-1146/FRC-93

Item No.	Interval					Item to be inspected	Procedures	Equipment is not ready/available if:
	B	D	A	W	M			
	•				•	Regulator loading	Apply known load to output of regulator and check for voltage change.	Regulator fails to maintain steady load voltage

Section V. ORGANIZATIONAL MAINTENANCE INSTRUCTIONS

8-18. General

Organizational maintenance instructions are covered in paragraphs 3-25, 3-26, and 3-27. Touchup painting is covered in paragraph 3-29.

8-19. Organizational Preventive Maintenance Checks and Services Chart for Regulator, Voltage CN-1146/FRC-93

W-Weekly		M-Monthly			Q-Quarterly	
Item No.	Interval			Item to be inspected	Procedures	
	W	M	Q			
1	•		•	Regulator stability	Apply known load to regulator and check output voltage stability	
2			•	Change generator output frequency slightly by reducing engine rpm.	Output voltage will remain stable with input power frequency change.	

Change 6 8-6

REGULATOR, VOLTAGE CN-1214/g

Section I. INTRODUCTION

9-1. Description

Regulator, Voltage CN-1214/G (Superior Electric Type IE525001) is mounted in a gray enamel, louvered cabinet. On the recessed front panel are an amber pilot light which indicates that the unit is energized; a control circuit fuse; a double-pole, single-throw circuit breaker to energize and protect the unit; a screwdriver adjustment control to vary the output voltage; and six output connector receptacles to connect the output to the load. The input terminal board is behind an access plate in the lower right-hand corner at the rear of the unit. Components are accessible for authorized repair through the removable top cover, which is fitted with lifting eyebolts at each corner to facilitate lifting by the use of a chain hoist.

9-2. Purpose and Use

a. Purpose. Regulator, Voltage CN-1214/G is designed to maintain an output voltage (115 volts alternating current (a.c.) root mean square (rms)

± 5 percent) for any combination of rated line and for a load from 1.0 to 0.8 power factor lagging.

b. Use. Regulator, Voltage CN-1214/G is intended for use with fixed radio station equipment.

9-3. Tabulated Data

Input voltage	80.5 to 149.5 volts a.c.
Frequency	48 to 63 Hz.
Output voltage	115 volts a.c.
Regulation	±5 percent.
Power factor	1.0 to 0.8 lagging.
Response time	400 milliseconds.
Minimum load	0.675 kilovolt ampere at unity power factor.
Kilowatt efficiency at full-load unit power factor and an input of 115 vac, 60 Hz.	80 percent minimum.
Kilowatt efficiency at all other combinations of rated input line and load.	70 percent minimum.
Distortion	12 percent rms maximum at rated line and load.
Temperature range:	
Operating	0° F. to +125° F.
Nonoperating	-20° F. to +160° F.

9-4. Items Comprising an Operable Regulator, Voltage CN-1214/G

NSN	Item	Qty	Dimensions			Weight (lb)
			Height	Depth	Width	
6110-00-832-4975	Regulator, Voltage CN-1214/G (Superior Electric Type 1ES25001). Running spares:	1	17 1/8	21 5/8	20 7/8	260 (approx)
5920-00-850-6091	Fuse, 1 amp, slo-blow	5				
6240-00-223-9100	Lamp, neon type NE-51	1				

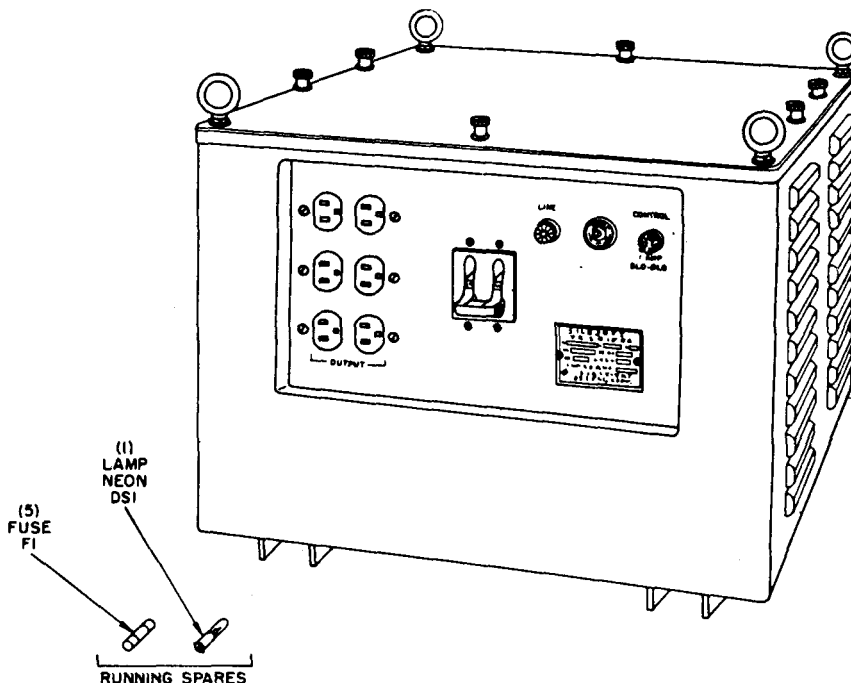

ELOD0025

Figure 9-1. Regulator, Voltage CN-1214/G front panel view.

Section II. INSTALLATION

9-5. Tools and Equipment Required for Installation

The tools and equipment required for installation of Regulator, Voltage CN-1214/G are listed below.

- a. *Tools.* Tool Kit, Electronic Equipment TK101/G.
- b. *Test Equipment.* Multimeter AN/USM-223.

9-6. Installation Procedure

The installation of Regulator, Voltage CN-1214/G consists only of removal of the equipment from the shipping box and hoisting it into a position on a bench

that will provide adequate ventilation, and connecting the input and output cables. Perform the operations listed below.

CAUTION

Provide ventilation for the unit to insure adequate heat dissipation. Avoid installing the unit close to heat-producing equipment such as space heaters.

- a. Hoist the regulator out of the shipping carton, and lower it onto a bench; use a chain hoist attached to the four eyebolts on the top.
- b. Locate the regulator on the bench in accordance with minimum clearances (fig. 9-2)
- c. Complete all external connections (A, fig. 9 3).

9-7. Controls and Indicators (fig. 9-3)

Control

Function

Circuit breaker	Used to turn unit on and off; provides overload protection.
OUTPUT VOLTAGE control	Used to set the desired output voltage.
LINE pilot light (amber)	Indicates when unit is energized
CONTROL circuit fuse.....	Control circuit protection.

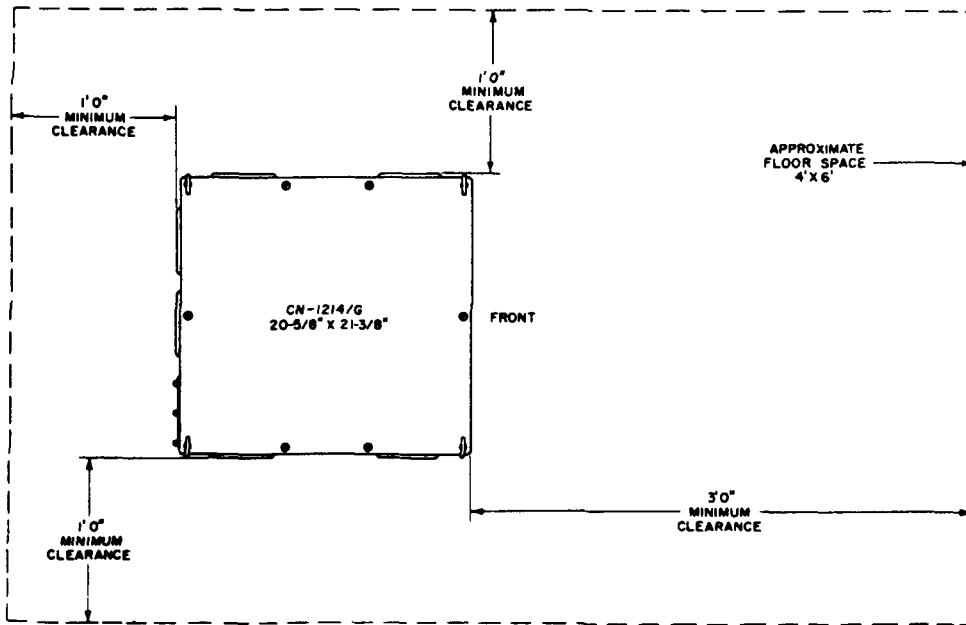

EL0D0026

Figure 9-2. Regulator, Voltage CN-1214/G, installation

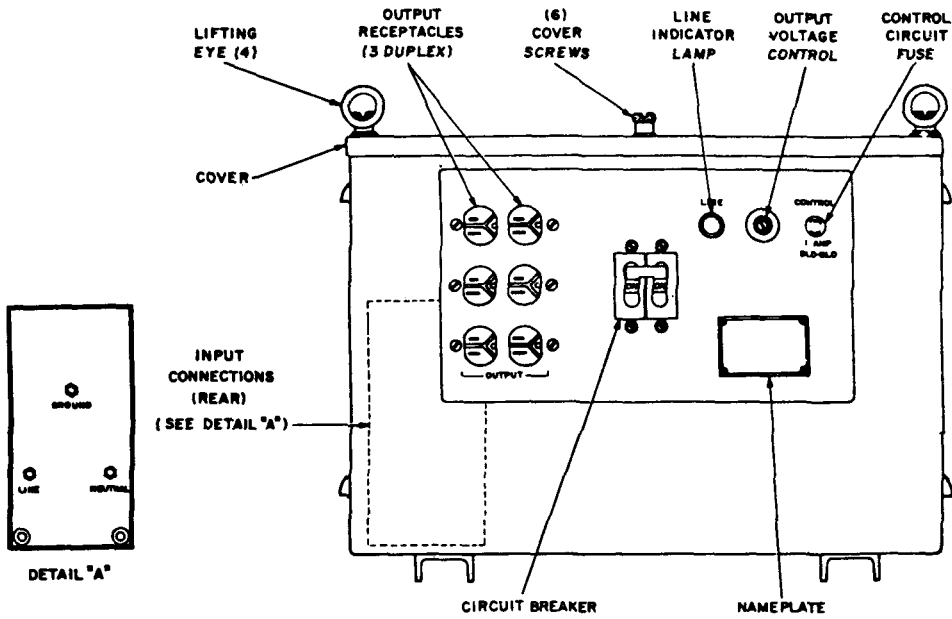

EL0D0027

Figure 9-3. Regulator, Voltage CN-1214/G, operating controls.

Section III. OPERATIONS

9-8. Operating Procedures

After the regulator has been installed and the installation wiring is checked, proceed as follows:

- a. See that the regulator and the equipment connected to it are turned off.
- b. Apply power to the unit; set the circuit breaker to ON (up). The LINE pilot lamp should light.

NOTE

If an abnormal indication is obtained during the starting procedure, higher category maintenance is necessary.

- c. Connect Multimeter AN/USM-223 to the OUTPUT receptacles.
- d. Remove the protective cap on the OUTPUT VOLTAGE control, loosen the locknut, and adjust the control to the desired output voltage with a

screwdriver. Tighten the locknut after adjustment.

NOTE

A 10- to 30-minute warmup period should be allowed before adjustment of output voltage, when a very exact setting is necessary.

- e. Energize the equipment connected to the output receptacles and note that the output voltage remains within the rated accuracy.

9-9. Stopping Procedures (fig. 9-3)

- a. Turn off the equipment by setting the circuit breaker to OFF (down).
- b. Observe that the LINE indicator lamp is extinguished.

Section IV. OPERATOR'S MAINTENANCE INSTRUCTORS

9-10. General

Operator's maintenance instructions are covered in paragraph 3-19 through 3-22. Cleaning is covered in paragraph 3-24.

9-11. Operator's Daily Checks and Services Chart for Regulator, Voltage CN-1214/G

B-Before

Item No.	Interval					Item to be inspected	Procedures	Equipment is not ready/ available if:
	B	D	A	W	M			
•						Taps and settings	Check that all taps and settings match input power and load requirements.-	If equipment fails to perform within the rated operating specifications..

Section V. ORGANIZATIONAL MAINTENANCE INSTRUCTIONS

9-12. General

Organizational maintenance instructions are covered in paragraphs 3-25,, 3-26, and 3-27. Touchup painting is covered in paragraph 3-29.

9-13. Deleted.

9-14. Quarterly Maintenance

Quarterly maintenance checks and services on Regulator, Voltage CN-1214/G are required. Periodic

daily and monthly services are a part of the quarterly preventive maintenance checks and services and must be performed concurrently. All deficiencies or shortcomings will be recorded in accordance with the requirements of TM 38-750. Perform all the checks and services listed in the quarterly preventive maintenance checks and services chart (para 9-15) in the sequence listed.

9-15. Deleted.

Section VI. TROUBLESHOOTING

9-16. Troubleshooting Procedure

Troubleshooting Regulator, Voltage CN-1214/G is based upon the operational check contained in the quarterly maintenance checks and services chart. To troubleshoot the equipment, check the operation as indicated by sequence number 7 in the quarterly pre-

ventive maintenance checks and services chart (para 9-15). Perform the checks and corrective measures indicated in the organizational troubleshooting chart. If the corrective measures indicated do not result in correction of the trouble, higher category maintenance is required.

9-17. Organizational Troubleshooting Chart

<i>Item No.</i>	<i>Trouble symptom</i>	<i>Probable trouble</i>	<i>Checks and corrective measures</i>
1	No input voltage	a. Circuit breaker CB1 tripped b. No Output voltage	a. Reset circuit breaker. b. If circuit breaker is not tripped, check input voltage and connections.
2	High output voltage	a. Input voltage high and/or output voltage incorrectly adjusted. b. Shorted silicon controlled rectifier c. Resistor assembly Z1 defective.	a. Check input voltage; make output voltage adjustment (para 9-18c). b. Higher category maintenance required. c. Higher category maintenance required.
3	Low output voltage	a. Control unit fuse F1 b. Output voltage improperly adjusted. c. Connector J1 improperly installed on printed circuit board A1. d. Connector J1 defective e. Resistors R1, R3, R4, R5, or R8 defective f Transformer T5 defective g. Resistor assembly Z1 defective	a. Replace defective fuse (para 9-18b). b. Adjust output voltage(para 9-18c) c. Press connector board tightly into printed circuit board. d. Higher category maintenance required. e. Higher category maintenance required. f. Higher category maintenance required. g. Higher category maintenance required.
4	LINE lamp does not light, and output voltage is normal.	Defective LINE lamp DS1	Replace LINE lamp (para 9-18a).

9-18. Repairs and Adjustments

a. Replacement of Indicator Lamp.

- (1) Unscrew pilot lamp lens.
- (2) Press in on the pilot lamp and turn it counterclockwise to unlock.
- (3) Pull defective lamp out and replace it with a new one. Push the lamp in and twist it clockwise to lock.
- (4) Reinstall pilot lamp lens.

b. Replacement of Control Circuit Fuse.

- (1) Unscrew fuse cap (front panel).
- (2) Remove fuse from cap.
- (3) Reinstall new fuse and cap, and twist clockwise to lock.

c. Adjustment of Output Voltage.

- (1) Connect Multimeter AN/USM-223 to the OUTPUT receptacle.

(2) Apply power to the unit with the circuit breaker set to OFF.

(3) Energize the unit by setting the circuit breaker to ON (up).

NOTE

Allow a 10- to 30-minute warmup period when a close setting is necessary.

(4) Remove the protective cap on the OUTPUT VOLTAGE control, loosen the locknut, and turn the control until the desired output is observed on Multimeter AN/U S M-223.

(5) Connect a load to the OUTPUT receptacle and energize the load.

(6) Observe that the output voltage remains within the rated accuracy (para 9-3).

(7) Lock the adjustment by tightening the locknut; replace the protective cap.

CHAPTER 10

CONTROL, RADIO SET C-618/FR-93 AND CONTROL, RADIO SET C-7515/FRC-93

Section I. INTRODUCTION

10-1. Description

Control, Radio Set, C 6118/FRC-93 (Collins 312B-4 and Control, Radio Set C-7515/FRC-93 (Collins 312B-5) will be referred to as the Collins 312B-4 and the Collins 312B-5 station controls (fig. 10-1). Each contains a directional coupler, wattmeter, a permanent magnet (pm) speaker, a phone patch, and appropriate switching circuitry. The same types of directional coupler, wattmeter, phone patch, and speaker are used in both the Collins 312B-4 and 312B-5. In addition, the Collins 312B-5 contains a variable-frequency oscillator to provide separate transmit and receive frequencies when used with the Collins KWM-2/2A. The wattmeter indicates power levels within the ranges of 0 to 200 or 0 to 2,000 watts, forward or reflected. It is accurate to within +5 percent over the range of 2

to 30 MHz. The phone patch uses circuitry which allows vox phone patch operation. It may also be switched manually if desired. The vfo used in the Collins 312B-5 is a 70K-2 oscillator which is the same as that used in the Collins KWM-2/2A. Switching circuits are provided to allow the operation of Collins KWM-212A on different transmit and receive frequencies or transmit-receive operation on the same frequency using either vfo. (Fig. 10-2) shows the location of external connections to the Collins 312B-5. The Collins 312B-4 is similar except for the absence of vfo connections. Items furnished with each equipment are listed in table 10-1.

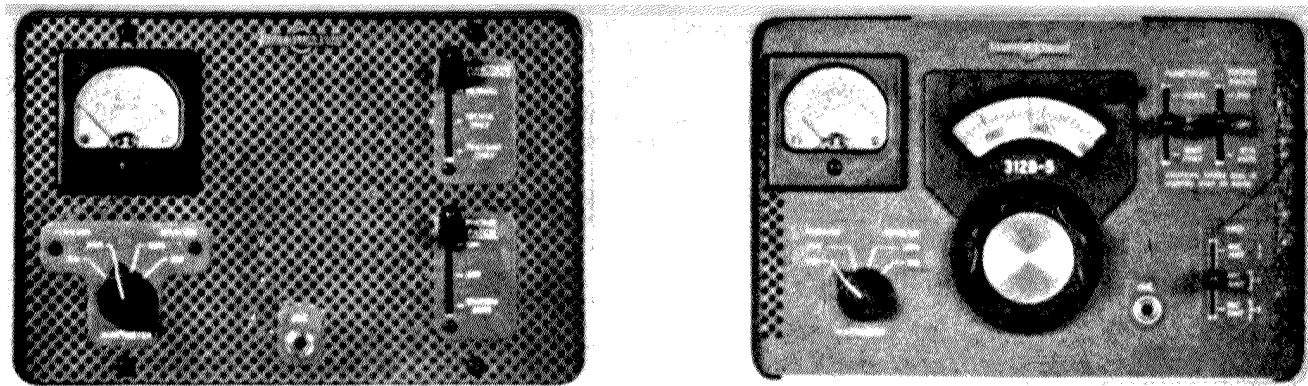

Figure 10-1. Collins 312B-4 and Collins 312B-5 station controls, front panel view operating controls.

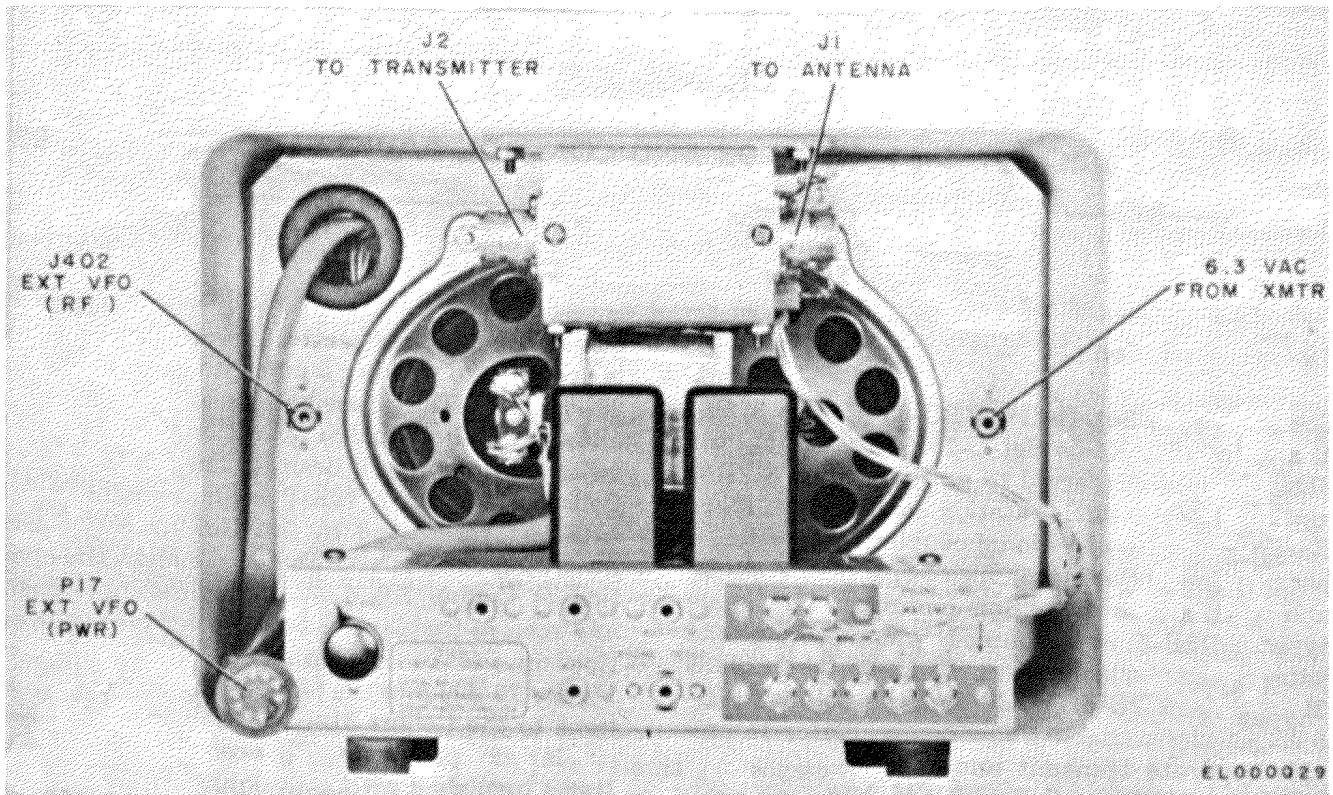

Figure 10-2. Collins 312B-5, external connections.

Table 10-1. Items Furnished With Collins 321B-4 and 312B-5

Quantity	Description	Function	Collins Part No.
1	Right-angle connector, RF type N.....	Antenna connection.....	357-9113-00
1	RG-58C/U cable with phono and N connectors.	Connect transmitter to coupler.....	426-6026-00
5	Audio cables with photo connectors.....	Interconnections.....	426-2027-00
1	Tubular capacitor, 0.5 μ f, 200 volts d.c.....	Install in phone patch, if required.....	931-0169-00
1	RG-58C/U cable with photo connectors.....	External vfo connection.....	426-5076-00

(Collins 312B-5 only)

10-2. Tabulated Data

Directional coupler and wattmeter:		Phone patch:	
Frequency range.....	2 to 30 MHz.	Input impedance.....	600 ohms..
Impedance.....	52 ohms unbalanced.	Output impedance.....	600 ohms
Wattmeter scales.....	200 watts, forward.	PM speaker	
	2,000 watts, forward.	Impedance.....	3 to 4 ohms
	200 watts, reflected	Size.....	5 by 7 inches
	2,000 watts, reflected.	Vfo in Collins 312B-5:	
Maximum power		Frequency range.....	2.5 to 2.7 MHz
Handling capability.....	2,000 watts forward power.	Calibration accuracy.....	Within 1 kHz
Power loss through coupler.....	Less than 0.1 percent.	Drift.....	Less than 100 Hz after 30 minute warm-up
Swr introduced by coupler.....	Less than 1.05:1.	Dial backlash.....	Less than 50 Hz
		Power.....	Supplied by Collins KWM-2/2A power supply.

10-3. Items Comprising an Operable Controls, Radio Set, C 6118/FR-93 and C-7515/FRC-93

NSN	Item	Dimensions			Weight
		Height	Depth	Width	
5820-00-082-4082	Control, Radio Set C-6118/FRC-93 (Collins 312B-4)	7 1/2	11 3/4	10 3/4	8 1/2
5820-00-702-2216	Control, Radio Set C-7515/FRC-93 (Collins 312B-5)	7 1/2	11 3/4	10 3/4	8 1/2

Section II. INSTALLATION

**10-4. Collins 312B-4 Interconnections
With Collins KWM 2/2A**

Make phone patch, speaker, and RF connections to the receiver, exciter, and telephone lines as shown in figure 10-4. If desired, the directional coupler may be removed from the Collins 312B-4 and mounted elsewhere. Figure 10 5 shows the proper way to reconnect the directional coupler to the indicator circuit.

NOTE

Other types of exciters may be used by connecting the PHONE PATCH OUT jack on the Collins 312B-4 to the exciter microphone jack. The output voltage at this jack on the phone patch is approximately equal to that of the average high impedance dynamic microphone.

**10-5. Collins 312B-5 Interconnections
With Collins KWM-2/2A**

Make power, phone patch, speaker, and RF connections to the transceiver and telephone lines as shown in figure 10 3. Use the RG -58C/U cables supplied for the RF connections. These cables are slightly larger in diameter and 2 inches shorter than those supplied for audio and control functions.

CAUTION

Be sure the vfo power plug is plugged into the proper socket on the Collins KWM-2/2A chassis. This socket is J17 which, for normal operation, has a molded jumper plug inserted in it.

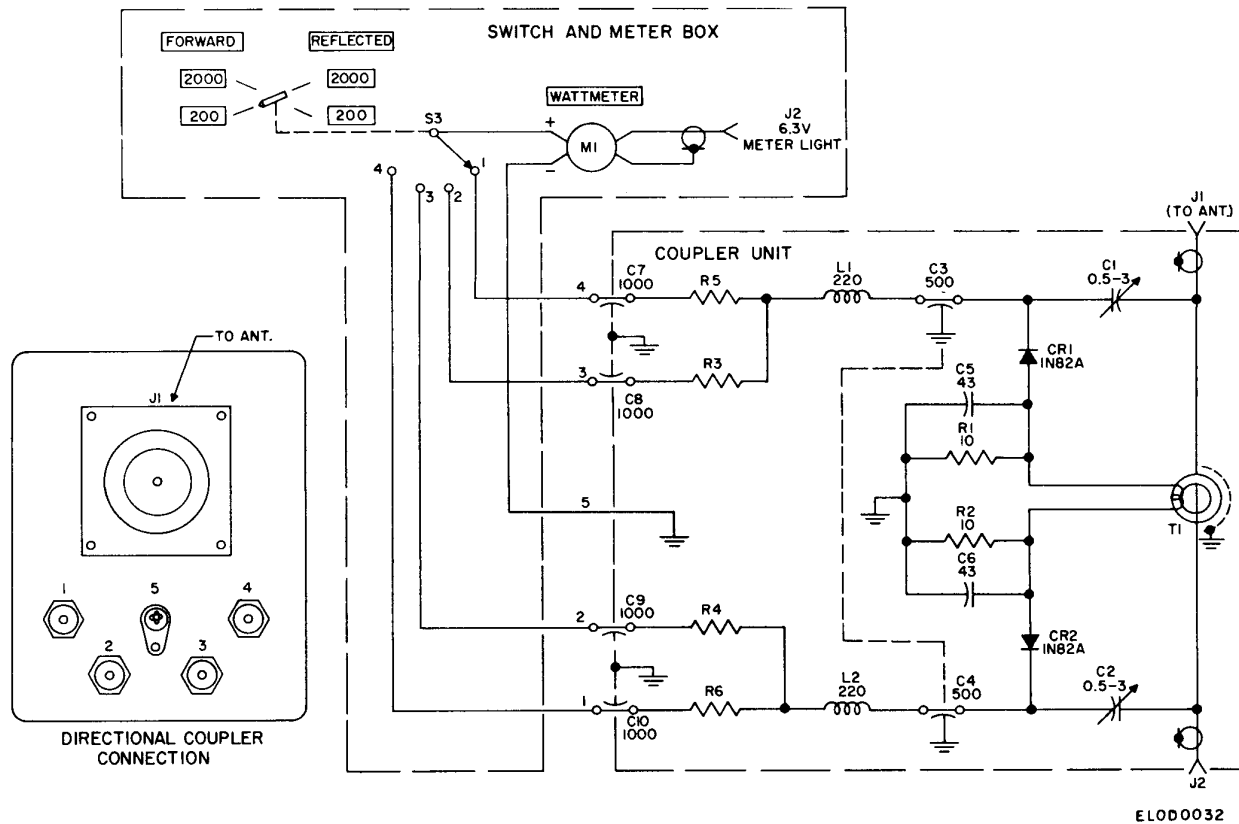

Figure 10-5. Wattmeter Interconnections.

Section III. OPERATION

10-6. Phone Patch Operation of Collins 312B 4/5 With Collins KWM-2/2A

- a. Set the EMISSION switch to LSB, ANTIVOX GAIN at minimum, MIC GAIN at minimum, VOX GAIN at minimum, and RF GAIN and AF GAIN as required for normal operation.
- b. Set the FUNCTION switch to CAL, and tune in the calibrate signal to produce approximately a 900-Hz audio tone.
- c. Set the VOX BAL control on the Collins 312B -4/5 /5 fully counterclockwise.
- d. Lift the telephone handset, and dial a single digit to remove the dial tone.
- e. Set the PHONE PATCH switch to ON.
- f. Advance the VOX GAIN control on the transceiver until the vox relays begin to trip back and forth between receive and transmit positions.

- g. Slowly adjust the VOX BAL control until the relays stop tripping.
- h. Repeat f and g above, until it is no longer possible to advance the VOX GAIN control without causing the relays to trip.

NOTE

1. The phone patch will balance on the average telephone line with the circuit capacities provided. Unusual line conditions may require a change in capacity to compensate for these conditions. If necessary, cut C7 loose, or add the extra capacitor (furnished) in parallel with C6 and C7 to produce a null within the range of the VOX BAL control.
2. More precise balancing may be obtained if an a.c. vtm is used. Connect

the vtm between the PHONE PATCH OUT jack (J4 on the Collins 312B -5) and ground. Slowly adjust the VOX BAL control for a null as indicated by the vtm.

i. Hang up the telephone, turn off the phone patch, and reset all transceiver controls for normal vox ssb operation.

j. The phone patch is now ready for use. The normal procedure is to set the PHONE PATCH switch to ST'N MUTE and call the third party on the telephone. Switch the phone patch on, and adjust the AF GAIN on the transceiver to provide normal telephone line level. If the received signal is strong, the RF GAIN may be decreased to reduce background noise.

k. Depending upon telephone line characteristics and voice volume of the incoming telephone signal, it may be necessary to make slight adjustments of the MIC GAIN and VOX GAIN. In case of extremely weak signals from the telephone line, manually switch the phone patch back and forth from REC ONLY to XMIT ONLY.

10-7. Operation of Directional Coupler and Wattmeter

The transmitter output power that can be handled safely is relative to the swr on the transmission line. If the swr is extremely high, as when the line is open or shorted, it is possible to obtain a forward power indication up to 2 kilowatts with very little power output from the transmitter. To avoid damage to the instrument, carefully observe the following operating procedure:

a. Set the wattmeter switch to the FORWARD 200 position. (If a linear amplifier is being used, set the switch to the FORWARD 2,000 position.)

b. Couple RF into the transmission line using cw emission. The meter should show a forward power indication. Note the reading.

c. Switch to the appropriate REFLECTED scale. Unless the antenna or load is perfectly matched to the transmission line (52 ohms, resistive), the meter will indicate reflected power. Note the reading.

CAUTION

Where doubt exists in regard to expected power output from a transmitter, always select the highest wattmeter scale first and, if necessary, switch to the lower scale. This action will prevent damage to the indicator.

d. The forward and reflected power readings, in conjunction with the chart of figure 10 6, may be

used to compute vswr. In some cases, it may be convenient to multiply the forward and reflected power readings by a factor of 10. The method of reading swr from the chart remains the same. For example, 50 watts forward and 5 watts reflected result in a value of swr slightly less than 2 to 1. Power levels of 500 watts forward and 50 watts reflected produce the same value of swr. If the reflected power is greater than the forward power indication, the coupler unit may have been improperly installed. Check to make sure that the coupler has not been installed backwards in the transmission line. Also make sure that the d.c. meter leads have not been reversed.

e. If forward and reflected power indications are equal, or reflected power is nearly equal to forward power, the swr on the line is extremely high. This usually indicates a shorted, open, or very poorly terminated line. The coupler will respond to harmonic and other spurious output as well as RF output at the desired frequency. If the transmitter output contains a high level of spurious emission, a high swr indication may be obtained even if the transmission line is terminated properly.

10-8. Operation of Station Control Switches

Table 10-2 lists operating conditions for the various settings of the FUNCTION and PHONE PATCH switches in the Collins 312B-4 and 312B-5. Refer to figure 10-1 for switch identification.

10-9. Operation of Vfo in Collins 312B-5 (fig. 10-1)

The switch positions of the VFO switch designate the two oscillators as number 1 and number 2. Number 1 is the vfo in the Collins KWM 2/2A. Number 2 is the vfo in the Collins 312B-5. The vfo switching arrangement allows instant selection of either of two preset frequencies within one band (one for net frequency and one for the frequency), scanning for a clear channel because of severe interference, and checking the local transmitter frequency for interference while making long distance communication.

a. With the VFO selector switch in the REC 1-XMIT 2 position, the receiver frequency is controlled by the dial settings of the Collins KWM-2/ 2A, and the transmitter frequency is controlled by the dial setting of the Collins 312B-5. This allows the transmit circuits to be set within one portion of the band and the receive circuits within another. For example, with the Collins 312B-5 dial

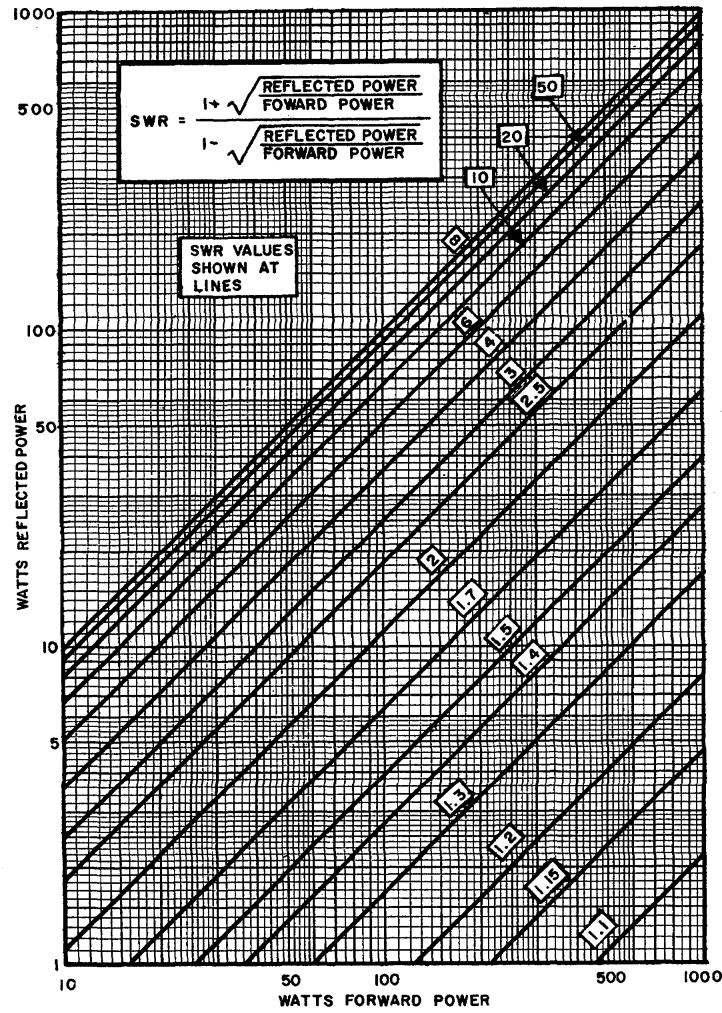

ELOC0033

Figure 10-6. View graph for forward versus reflected power.
 Table 10-2. Operation of Phone Patch and Function Switches

Function switch position	Phone patch switch positions		
	On	Off	Station mute
NORMAL	Speaker dead, MIC dead, PTT operative, VOX operative, patch connected.	Speaker live, MIC live, PTT operative, VOX operative, patch disconnected.	Speaker dead, MIC dead, transmitter input grounded*, PTT inoperative.
RECEIVE ONLY	Speaker dead, transmitter input grounded*, PTT inoperative, MIC dead, patch hears receiver.	Speaker live, PTT inoperative, transmitter input grounded*, patch disconnected.	Same as above.
TRANSMIT ONLY	Speaker dead, PTT operative, MIC dead, antivox voltage grounded.	Speaker dead, PTT operative, MIC live, antivox voltage grounded.	Same as above.

*PHONE PATCH OUT jack (J4) shorted.

set to 14.296 MHz and the EMISSION switch on the KWM-2/2A set to TUNE, the transmit circuits may be peaked and the pa loaded. The EMISSION switch is then set back to the desired sideband or CW, and the Collins KWM-2/2A dial tuned to a desired receiving frequency between 14.3 and 14.350 MHz (table 10-3).

b. With the VFO selector switch in the REC 1-XMIT 1 position, both the receiver and transmitter frequencies are the same and are controlled by the vfo in the transceiver.

c. With the VFO selector switch in the REC 2-XMIT 2 position, both the receiver and transmitter frequencies are the same and are controlled by the vfo in the Collins 312B-5. The vfo dial in the Collins 312B-5 can be calibrated in this position using the crystal calibrator signal and zero set knob as outlined in paragraphs 3-9 through 3-13. With the Collins 312B-5 VFO switch set in REC 1-XMIT 1 position, the Collins KWM-2/2A may be tuned and loaded to one selected frequency within the legal amateur band using the Collins KWM-

2/2A tuning dial. The VFO switch may then be changed to REC 2-XMIT 2 position, and the Collins 312B-5 dial adjusted to another selected frequency within the same band. Transceiver operation may then be changed instantly from one frequency to the other by operating the VFO switch on the Collins 312B-5 back and forth between the two positions marked REC 1-XMIT 1 and REC 2-XMIT 2. This action permits presetting to a net frequency and a net QSY frequency, and the instant selection of either during net operation. Frequency separation limits listed in table 10-3 should not be exceeded by any great extent. If they are exceeded, the result is decreased receiver sensitivity or transmitter pa grid drive (or both) due to the selectivity of the transceiver RF tuned circuits. The best compromise for this tuned circuit attenuation effect is to tune and load the Collins KWM-2/2A at a frequency midway between the two desired frequencies and then set the Collins 312B-2 and Collins KWM-2/2A dials to the required frequencies.

Table 10-3. Collins KWM-2/2A and Collins 312B-5 Approximate Vfo Frequency Separation Limits

	Band (M Hz)				
	3.4-4	7-7.4	14-14.4	21-21.6	28-30
Approximate limit of separation between Collins 312B-5 and Collins KWM-2/2A dials.	15 kHz	30 kHz	50 kHz	75 kHz	100 kHz

Section IV. OPERATOR'S MAINTENANCE INSTRUCTIONS

10-10. General

Operator's maintenance instructions are covered in paragraph 3-19 through 3-22. Cleaning is covered in paragraph 3-24.

10-11. Operator's Preventive Maintenance Checks and Services Chart for Controls, Radio Set C-6118/FRC-93 and C-75151/FRC-93

B-Before
D-During

A-After
W-Weekly

M-Monthly

Item No.	Interval					Item to be inspected	Procedure	Equipment is not ready/available if:
	B	D	A	W	M			
	•					Equipment performance	Check operation of VFO with transmitter on dummy load using frequency counter.	Frequency fails to track or lacks stability once tuned to fixed frequency.

TM 11-5820-55-12

Section V. ORGANIZATIONAL MAINTENANCE INSTRUCTIONS

10-12. General

Organizational maintenance instructions are covered in paragraph 3-25, 3-26, and 3-27. Touchup painting covered in paragraph 3-29.

10-13. Organizational Preventive Maintenance Checks and Services Chart for Controls, Radio Set C6118/FRC-93 and C-7515/FRC-93

W-Weekly

M-Monthly

Q-Quarterly

Item No.	Interval				Item to be inspected	Procedure
	W	M	Q			
		•			VFO stability.	Connect RT-718/FRC-93 with VFO to dummy load. Using freq counter check for freq drift.

CHAPTER 11

AMPLIFIER, RF AM-3979/FR-93

Section I. INTRODUCTION

11-1. General

This chapter describes Amplifier, RF AM-3979/ FRC 93 (Collins 30L-1). This amplifier is used to increase the output of the AN/FRC-93 to 1,000 watts and allows communication over greater distances. It is portable, but can be used in a mobile station by mounting it on a Collins 351E-4 mounting plate. Case, Electrical Equipment CY-6197/ GRC-159 is used for carrying the amplifier in port" able applications.

11-2. Tabulated Data

Frequency range.....	3.6 to 29.7 MHz covering all amateur bands. By retuning input coils as necessary, the following general-coverage bands may be covered:
	<i>Frequency band Total coverage</i>
	3.5 MHz 3.4 to 5.0 MHz
	7.0 MHz 6.5 to 9.5 MHz
	14 MHz 9.5 to 16.0 MHz
	21 MHz 16.0 to 22.0 MHz
	28 MHz 22.0 to 30.0 MHz
Mode.....	Ssb or cw.

Type of service	Ssb-continuous voice modulation. Cw-50 percent duty cycle(continuous keydown conditions not to exceed 30 seconds duration).
Plate power input.....	Cw-1,000 watts. Ssb-nominal pep input of 1,000 watts with speech. Third order distortion products at this level are at least 30 db down from signal.
Drive power requirements	70 watts.
Primary power requirements	230 volts a.c. ±10%, 3 wire, single phase, at 7.5 amperes maximum, or 115 volts a.c. ±10% at 15 amperes maximum, 50 to 400 Hz. Operation from a line frequency other than 50 to 60 Hz requires an auxiliary 60-Hz supply for a fan motor.
Input impedance	52 ohms.
Output impedance	52 ohms unbalanced with vswr not to exceed 20 to 1 on the amateur bands.
Noise level	40 db down from output signal with 1 kilowatt single-tone input.
Harmonic output	All harmonics at least 40 db down from output signal.

11-3. Items Comprising an Operable Amplifier, Radio Frequency AM 3979/FRC-93

NSN	Item	Dimensions			Weight
		Height	Depth	Width	
5820-00-082-4081	Amplifier, Radio Frequency, AM-3979/FRC-93 (Collins 30L-1).....	6 9/16	13 ¾	14 3/4	38

Section II. INSTALLATION

11-4. Unpacking

Carefully remove the packing material. Examine for visible damage. If the amplifier has been damaged in shipment, refer to paragraph 1-3. Check tuning controls and switches for freedom of action. Check the equipment included with the

amplifier against table 11-1. Lift the amplifier cabinet lid. Loosen the 10 screws in the RF compartment cover, slide it forward, and lift it off. Remove the packing material around the tubes. Replace the cover and tighten the screws. Lower the lid.

TM 11-5820-554-12

Table 11-1. Equipment furnished with Collins 30L-1

Quantity	Description	Function	Collins Part No.
2	Shielded cables, 4 feet long, with phono plug on each end	Alc and antenna relay cables	426-2027-00
1	RG-58C/U cable, 4 feet long, with phono plug on each end	RF input cable	426-5079-00
6	Fuses, 8 amperes	Spares	264-4110-00
1	A.c. power plug adapter	A.c. power	368-0138-00
1	UG-21D/U coaxial plug	RF output connector	357-9261-00
1	Number 6 Bristo wrench	Knob removal	024-9730-00
1	Number 8 Bristo wrench	Knob removal	024-0019-00
1	Coaxial plug (Amphenol type 82-838)	Right angle cable plug	357-9113-00

instructions for type N connectors, such as the UG~21D/U, are shown in figure 11-1.

11-5. Power Transformer Connections

The Collins 30L-1 is shipped from the factory with the transformer primary connected for 115 volts a.c. If 230-volt a.c. operation is planned, the primary connections must be changed on terminal board TB1. This board is located at the bottom of the power supply compartment. These connections will be made by direct support personnel.

WARNING

DO NOT BLOCK INTERLOCK SWITCHES. Dangerous voltages are present in this equipment. The high voltage is interlocked with the amplifier covers. NEVER put the amplifier into service until all compartment covers are in place.

11-6. Cabling

Interconnections with other station equipments are described in paragraphs 11-7, 11-8, and 11-9. Assembly

11-7. Portable (Traveling) Station

(fig. 11-2)

The Collins 30L-1 is particularly applicable to traveling station use in conjunction with the Collins KWM-2/2A transceivers. Make sure the transformer primary is connected for proper line voltage.

11-8. Fixed (Home) Station

Connect the Collins 30L-1 to the Collins KWM-21 2A as shown in figure 11-3. Check to see that the transformer primary is properly connected for the input voltage to be used.

11-9. Mobile Station

Connect the Collins 30L-1 to the Collins KWM-2/ 2A as shown in figure 11-2 or 11-3. When the use of Collins 312B-5 is desired, refer to figure 11-3. In a mobile station, Power Supply PP - 4765/GRC-159 or Collins MP-1 is used in place of Power Supply PP -4151/FRC 93.

TM 11-5820-554-12

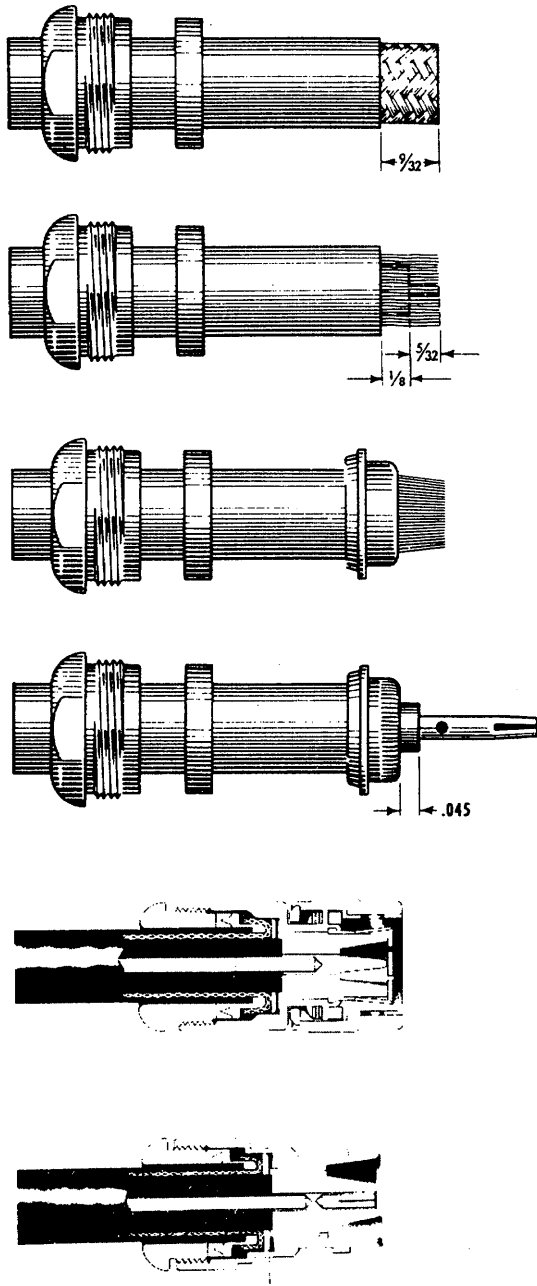
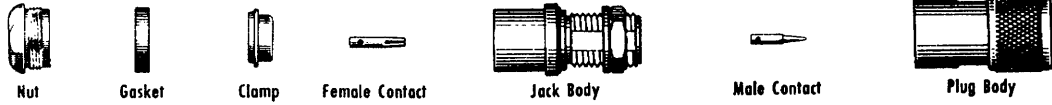

Place nut and gasket over cable and cut off jacket $9/32$ " from end.

Comb out braid and fold out. Cut off cable dielectric flush $1/8$ " from end of jacket.

Pull braid wires forward and taper toward center conductor. Place clamp over braid and push back against cable jacket.

Fold back braid wires as shown, trim to proper length and form over clamp as shown. Solder contact to center conductor.

Insert cable and parts into connector body. Make sure sharp edge of clamp seats properly in gasket. Tighten nut.

Figure 11-1. Connector assembly instructions.

EL000054

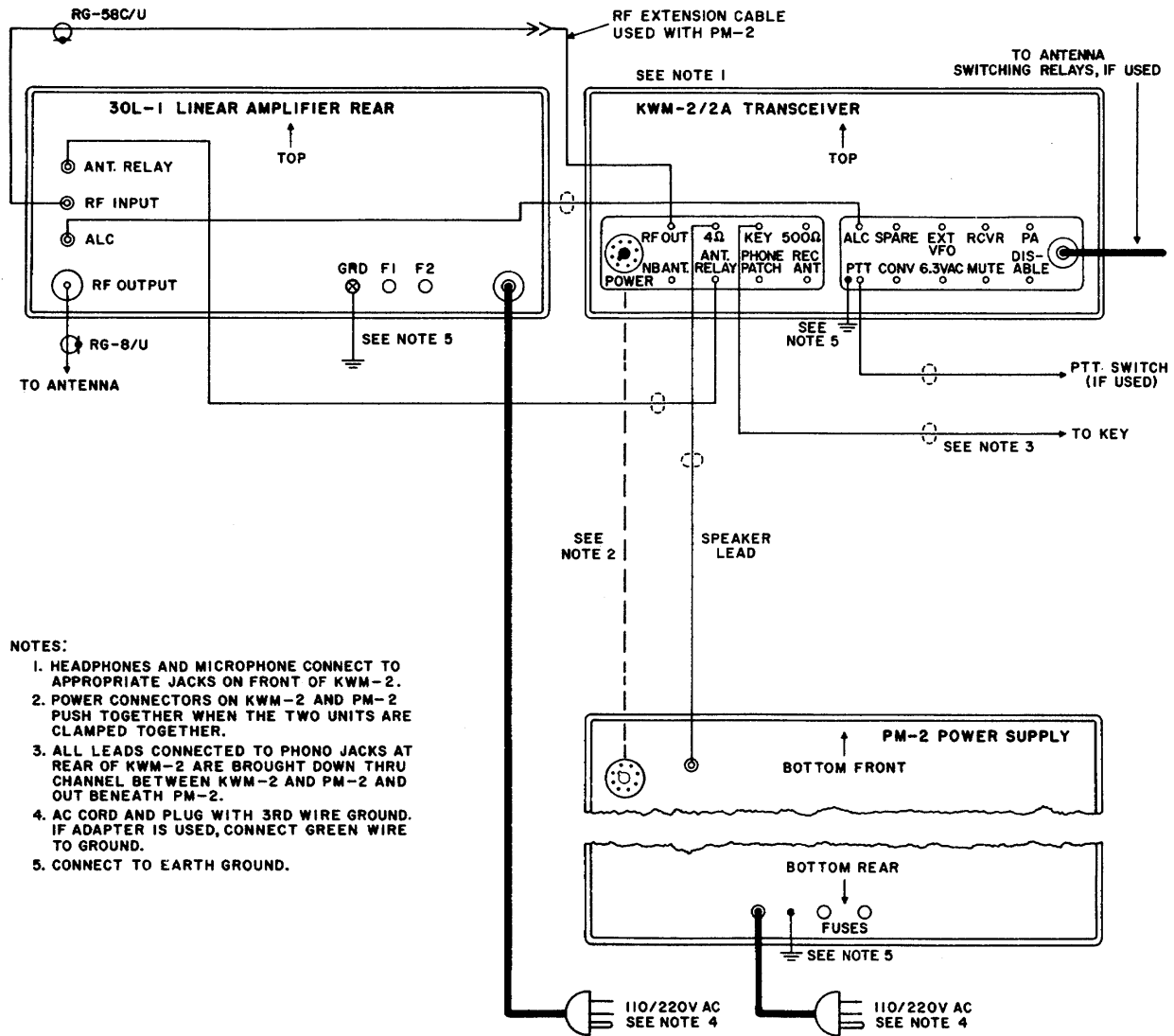

NOTES:

1. HEADPHONES AND MICROPHONE CONNECT TO APPROPRIATE JACKS ON FRONT OF KWM-2.
2. POWER CONNECTORS ON KWM-2 AND PM-2 PUSH TOGETHER WHEN THE TWO UNITS ARE CLAMPED TOGETHER.
3. ALL LEADS CONNECTED TO PHONO JACKS AT REAR OF KWM-2 ARE BROUGHT DOWN THRU CHANNEL BETWEEN KWM-2 AND PM-2 AND OUT BENEATH PM-2.
4. AC CORD AND PLUG WITH 3RD WIRE GROUND. IF ADAPTER IS USED, CONNECT GREEN WIRE TO GROUND.
5. CONNECT TO EARTH GROUND.

ELOD0034

Figure 11-2. Interconnection with Collins KWM-2/2A portable (traveling) station.

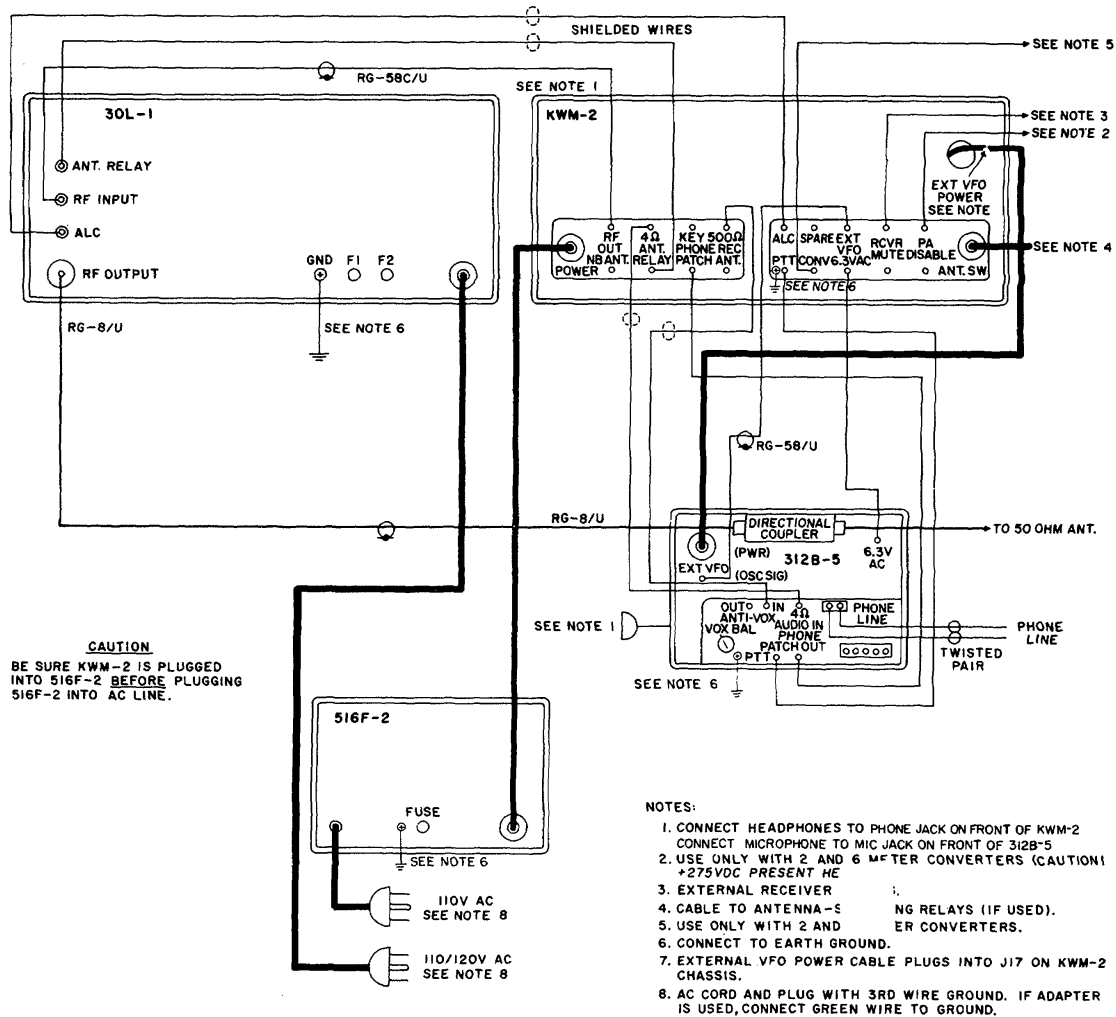

Figure 11-3. Fixed or mobile station interconnections.

ELOD0055

Section III. OPERATION

11-10. Operation in Amateur Bands

Table 11-2 shows normal full-scale meter readings if the exciter is a Collins KWM-2/2A. Set the exciter BIAS ADJUST to produce an idling plate current of 50 ma. Tune and load according to instructions in paragraph 3-12

a. Connect the antenna for the band in use to the RF OUTPUT jack on the Collins 30L-1. (When the ON-OFF switch is in the OFF position, the

transfer relay in the Collins 30L-1 connects the antenna to the exciter.)

b. Be sure the ON-OFF switch in the Collins 30L-1 is in the OFF position (fig. 11-4).

c. Tune and load the Collins KWM-2/2A into the antenna. If the antenna does not present a nearly 50-ohm resistive load, the exciter can be tuned and loaded into a 50-ohm dummy load such as the DA-75/W. When switched to the input of the Col

TM 11-5820-554-12

Collins 30L-1, the Collins KWM-2/2A will then remain in tune.

d. Set the Collins KWM-2/2A EMISSION switch to the TUNE position, and set the MIC GAIN to the OFF position.

e. Set the Collins 30L-1 METER switch to the TUNE position.

f. Set the BAND switch to the same band as that of the Collins KWM-2/2A, the LOADING control to 1 on the dial, and the TUNING control to the white area for the band in use.

g. Press the Collins 30L-1 ON-OFF switch to the ON position.

h. Set the MIC GAIN control to about three-quarter full scale.

i. Immediately adjust the TUNING control for multimeter dip.

j. Alternately adjust the TUNING and LOADING controls for zero multimeter reading. The meter will indicate zero at the dip when the amplifier is properly tuned and loaded. Always make the TUNING adjustment for meter dip the last adjustment.

k. Switch the Collins KWM-2/2A to the desired sideband or to cw, and reduce the MIC GAIN control to normal operating level. The station is now ready to operate at rated power input.

l. Once the equipment has been tuned up on a given frequency, the Collins 30L-1 may be switched into or out of the circuit by operating the ON-OFF switch. Output power from the amplifier is available instantly with no warm-up period required.

CAUTION

DO NOT operate the Collins 30L-1 into a load presenting a vswr greater than 2 to 1. The equipment may not function properly and damage may result. DO NOT operate the amplifier in continuous key-down condition at full input for more than 30 seconds. The power supply may be damaged. DO NOT use the Collins 30L-1 in fsk, am., or fm service. DO NOT use slow-blow fuses or fuses larger than the 8-ampere type supplied.

11-11. Operation Outside Amateur Bands

Operation outside amateur bands requires retuning of the Collins 30L-1 input circuits. This action is necessary to present the proper load impedance to the exciter. Direct support will retune the input circuits (TM 11-5820-55403401).

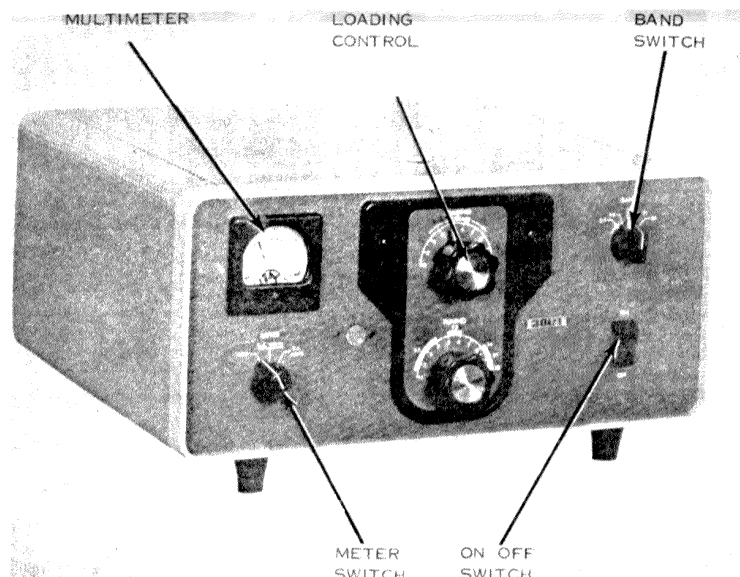

Figure 11-4. Collins 30L-1, operating controls.

Table 11-2. Multimeter Scale Values.

<i>Meter switch setting</i>	<i>Full scale indication</i>	<i>Normal indication</i>
TUNE	Not applicable	Zero when Collins 30L-1 is properly loaded
DC VOLTS	2,000 volts	1,800 volts (no modulation)
		1,600 volts (at rated load)
DC AMPS.....	1.0 amp (1,000 ma)	600 ma (keydown cw)
		300 to 350 ma (ssb voice peaks)
		110 ma (keyed, no excitation)

Section IV. OPERATOR'S MAINTENANCE INSTRUCTIONS

11-12. General

Operator's maintenance instructions are covered in paragraphs 3-19 through 3-22. Cleaning is covered in paragraph 3-24.

11-13. Operator's Preventive Maintenance Checks and Services Chart for Amplifier, RF AM-3979/FRC-93 (Collins 30L-1)

B-Before

Item No.	Interval					Item to be inspected	Procedure	Equipment is not ready/available if:
	B	D	A	W	M			
	•					Multimeter checks	Perform steps in table 11-2.	Equipment meter readings given in table 11-2 are 5% off given values.

Section V. ORGANIZATIONAL MAINTENANCE INSTRUCTIONS

11-14. General

Organizational preventive maintenance instructions are covered in paragraph 3-25, 3-26, and 3-27. Touchup painting is covered in paragraph 3-29.

11-15. Organization Preventive Maintenance Checks and Services Chart for Amplifier, RF AM-3979/FRC-93 (Collins 30L-1)

W-Weekly

M-Monthly

Q-Quarterly

Item No.	Interval			Item to be inspected	Procedure
	W	M	Q		
			•	Equipment performance..	Check meter checks as outlined in table 11-2 above. Check condition of output tank coils and tuning assemblies for evidence of rf damage.

CHAPTER 12

COUPLER, ANTENNA CU-2004/U

12-1. Description

Coupler, Antenna CU-2004/U (Collins 180S-1) referred to as antenna coupler, is basically a 1-kw pi-network for matching various antenna impedances

to a 50-ohm coaxial transmission line in the range of 3 to 30 MHz. It is used as an L-network in most cases, but when the L-network cannot match the desired antenna, the complete pi circuit is used.

12-2. Items Comprising Coupler, Antenna CU-2004/U

NSN	Item	Qty	Dimensions (in)			Weight (lb)
			Height	Depth	Width	
5820-00-034-4241	Coupler, Antenna, CU-2004/U (Collins 180S-1).....	1	7 7/8	12 3/4	10 1/4	

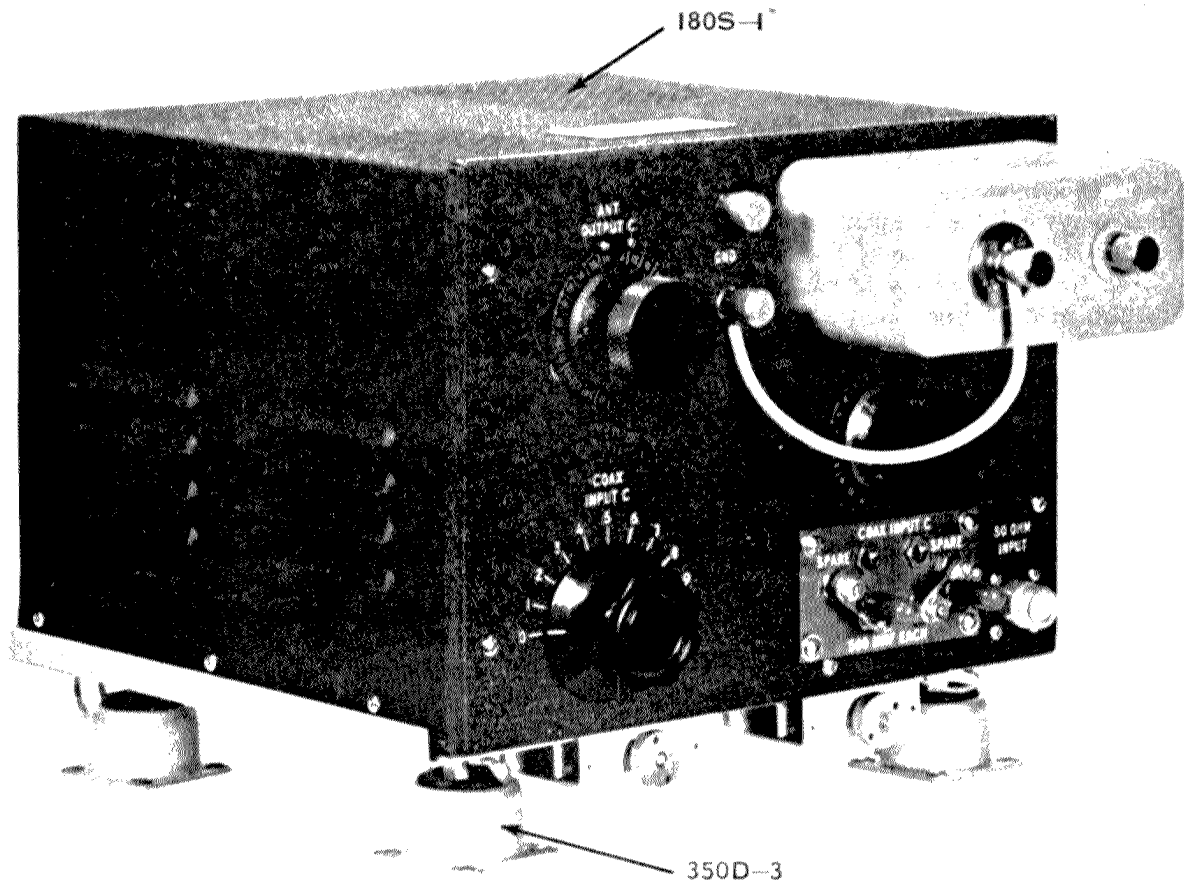

Figure 12-1. Coupler, Antenna CU-2004/U and Collins 350D-3 shockmount

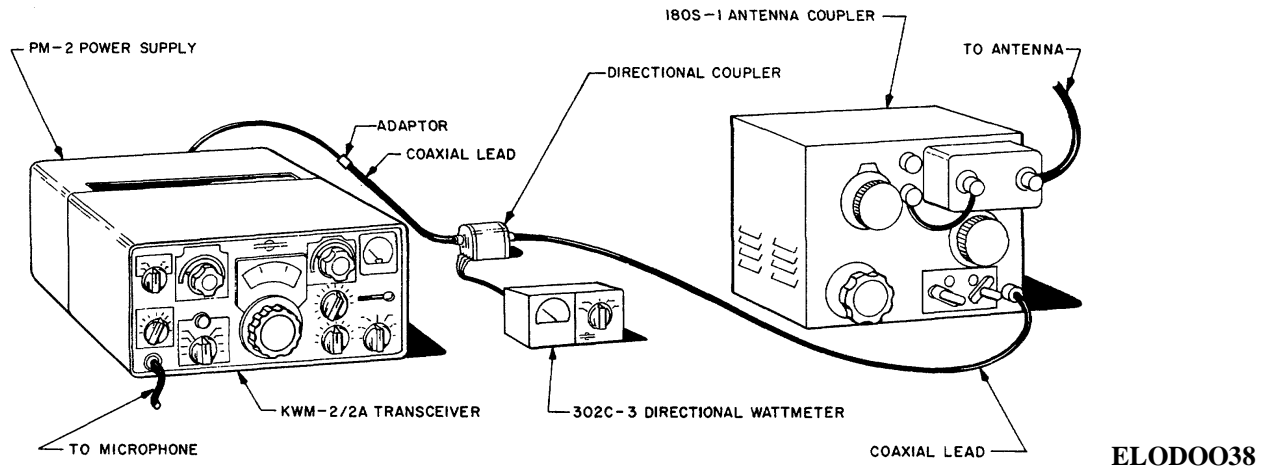

Figure 12-2. CU-2004/U and Collins KWM-2/2A, hookup diagram.

12-3. Installation (fig. 12-2)

Keep the antenna lead-in inside the building as short as possible. If the coupler is used inside an aircraft, the lead-in inside the aircraft should be as short as 12 inches. This lead length influences the selection of a mounting position for the coupler. With a heavy conductor such as shield braid, attach the GROUND terminal of the coupler to a good ground. Ground radials buried below the surface of the ground may be necessary. If the installation is in an aircraft, attach the ground wire to the skin of the aircraft.

12-4. Tuning Procedure

- a. Connect the Collins KWM-2/2A, 302C 3 directional wattmeter and antenna coupler as shown in figure 12-2. Leave the coaxial lead disconnected from the coupler at this time.
- b. Connect a dummy load to the coaxial lead from the directional coupler. Use any 50-ohm load capable of dissipating the power output expected from the transmitter.
- c. Tune and load the Collins KWM-2/2A according to paragraph 3-12.
- d. Remove the dummy load from the circuit, and connect the coaxial lead to the antenna coupler in place of the dummy load.
- e. Put the COAX INPUT C jumpers in the SPARE jacks. Set the COAX INPUT C dial to zero. Connect the wire antenna to the terminal

marked SHUNT. Connect the ground strap from the terminal marked SERIES to the ground terminal. Set the ANT OUTPUT C control to 24-00. Set the SERIES COIL to zero.

- f. Switch the wattmeter to the 200 WATTS REFLECTED position (or use an swr meter).
- g. Set the Collins KWM-2/2A EMISSION switch to LOCK.
- h. With the COAX INPUT C control maintain the Collins KWM-2/2A plate current at maximum, but no higher than 210 ma.
- i. With the SERIES COIL control, find the plate current dip, and watch the reflected power indication at the same time.
- j. When properly tuned, the COAX INPUT C control will maintain loading and should be set for plate current between 200 and 230 ma. The SERIES COIL control maintains antenna resonance and should be used to dip the plate current and the reflected power indications to minimum.
- k. If the COAX INPUT C control reaches maximum (dial reads 10), add in one of the 500- μ f capacitors, using one of the COAX INPUT C jumpers.
- l. If a unity swr still cannot be obtained, connect the antenna to the terminal marked SERIES, and repeat h, i, and k above at the same time adjusting the ANTENNA OUTPUT C along with the controls in h and i above. (Maximum C is obtained when the dial reads 0.)

TM 11-5820-554-12

m. If it is still impossible to obtain a unity swr, connect the antenna to the terminal marked SHUNT, and connect a jumper from the terminal marked SERIES to ground. Then repeat *h*, *i*, and *k* above at the same tune adjusting ANTENNA OUTPUT C along with the controls in *h* and *i* above.

n. If a unity swr cannot be obtained with any of the above combinations, the antenna impedance is probably beyond the range of the antenna coupler. However, the coupler should handle almost any reasonable antenna with the exception of very short antennas at low frequencies (less than 1/8 wavelength below 7 MHz). Where unity swr cannot be obtained, use the minimum Swr that can be obtained. If the swr cannot be made less than 2.5 to 1, the antenna length should be either increased or decreased until a better match can be made.

o. Note that on the higher frequencies (20 to 30 MHz), the setting of the various controls becomes quite critical. When tuning adjustments are made, adjust the controls slowly so that the proper setting will not be passed over too quickly to be noticed.

p. As the transmitter frequency is moved about in normal operating procedures, watch the swr, and if it becomes excessive, begin the tuning procedures again.

q. A combination of ANT OUTPUT C and SERIES COIL settings may optimize the minimum reflected power indication. A number of combinations of settings of the above controls may produce resonance. In general, the highest dial setting for ANT OUTPUT C producing resonance will produce the best results.

r. Make a log of the settings for each frequency. If there are no changes in the antenna system, it should be possible to return to a given frequency by setting up the dial numbers without having to go through the entire tuning procedure.

12-5. Operator's Maintenance Instructions

Operator's maintenance instructions are covered in paragraphs 3-19 through 3-22. Cleaning is covered in paragraph 3-24.

12-6. Operator's Preventive Maintenance Checks and Services Chart for Coupler, Antenna CU-2004/U

B-Before

Item No.	Interval					Item to be inspected	Procedure	Equipment is not ready/available if:
	B	D	A	W	M			
	•					Rf connectors	Check for damage or corrosion.	Connectors cause SWR to be unable to be corrected.

12-7. Organizational Maintenance Instructions

Organizational preventive maintenance instructions are covered in paragraphs 3-26, 3-26, and 3-27. Touchup painting is covered in paragraph 3-29.

12-8. Organizational Preventive Maintenance Checks and Services Chart for Coupler, Antenna CU-2004/U

W-Weekly

M-Monthly

Q-Quarterly

Item No.	Interval				Item to be inspected	Procedure
	W	M	Q			
			•		Tuning unit.	Terminate tuning unit in dummy load. While changing control settings observe VSWR. SWR will remain constant. If not, check tuning unit components.

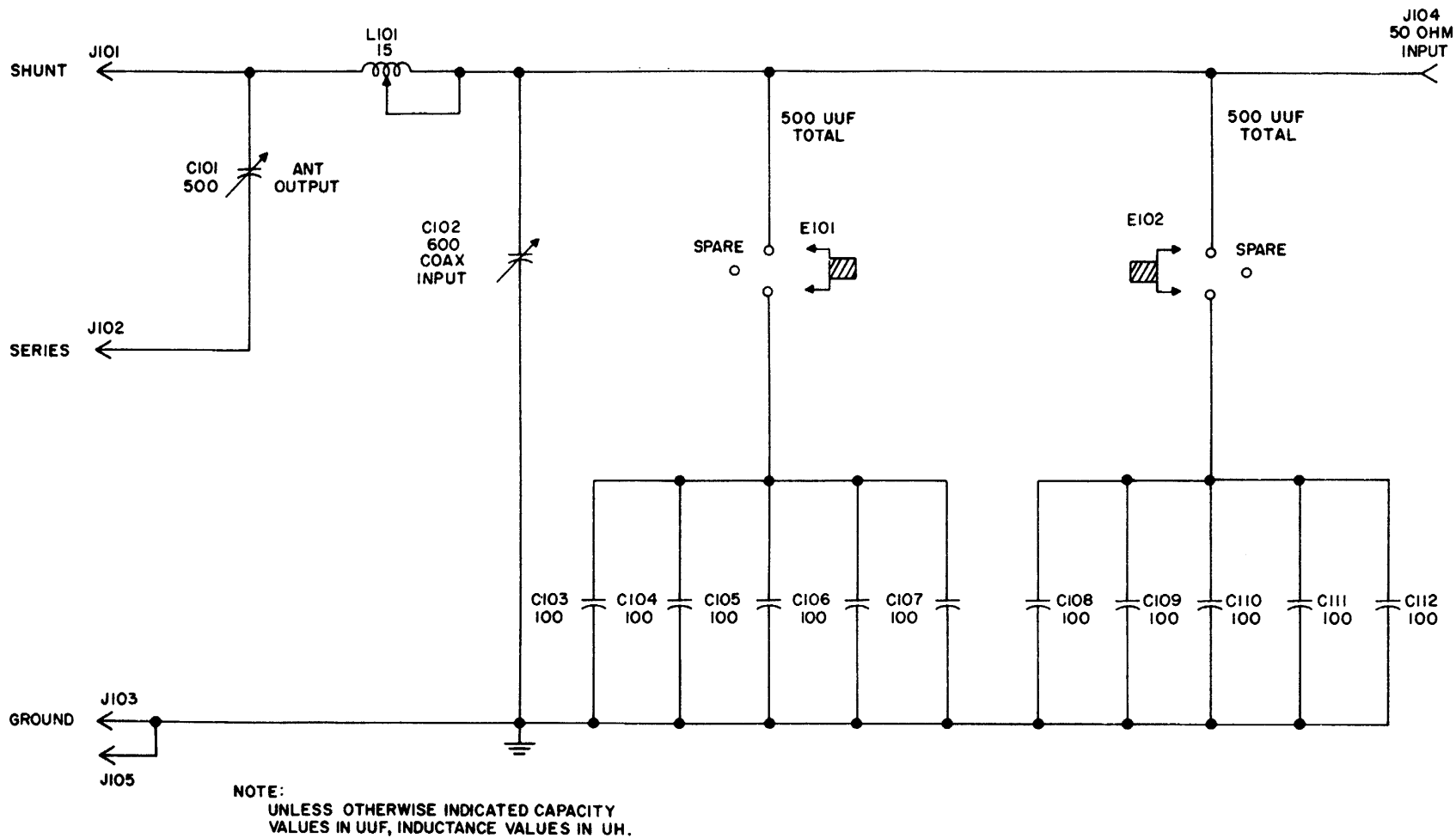

Figure 12-3. Antenna Coupler CU - 2004/U, schematic diagram.

ELOD0039

CHAPTER 13

ANTENNA, TRANSPORTABLE

Section I. INTRODUCTION

13-1. Description

The Transportable antenna (Collins 637T-2) is an adjustable dipole antenna designed for use with portable, tactical, and amateur radio systems. It can also be used effectively as a backup antenna for vehicular and shelter-mounted communication systems. It is capable of operating on communication circuits extending to 1,000 miles. The Collins 637T-2 is operational in the 3.4- to 30-MHz range. At dipole heights of 15 to 40 feet, the Collins 637T2 provides short range skywave

communications at frequencies up to 10 MHz. Operation at higher frequencies provides bidirectional azimuthal coverage for ranges of approximately 300 to 1,000 miles. The phosphor-bronze wire rope radiating elements of the Collins 637T-2 are extremely durable and do not reflect sunlight. The elements can be set to resonate length by observing the dials built into the housing. A ferrite balun in the antenna housing transforms the balanced dipole circuit to 60 ohms unbalanced. The antenna can be deployed by one man in 5 to 20 minutes.

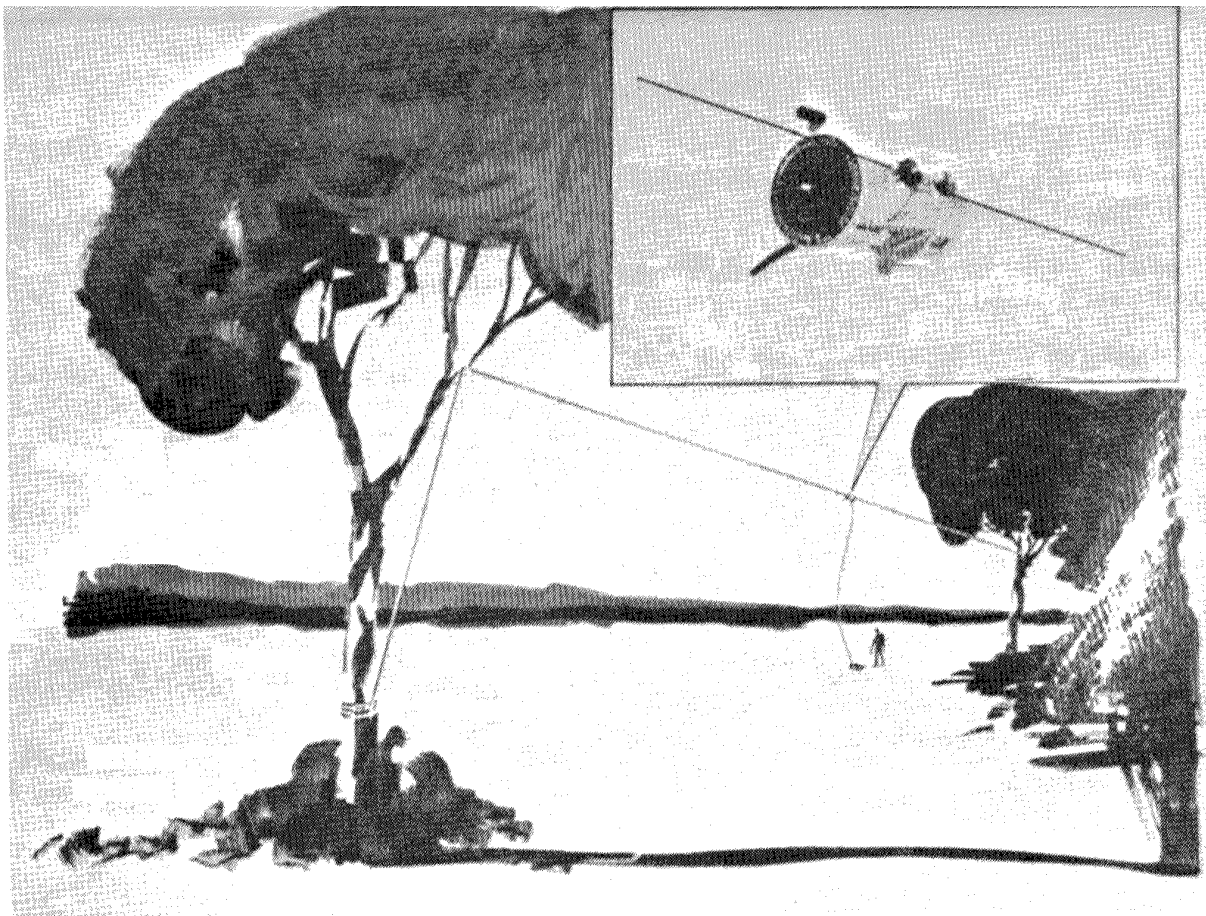

Figure 13-1. Transportable antenna (Collins 637T-2).

TM 11-5820-554-12

13-2. Tabulated Data

Electrical:		Element length (2 ea)	73 feet
Frequency range	3.4 to 30 MHz.	Temperature range	-60°F to 140°F
Polarization	Horizontal	Humidity range	0 to 95%
Impedance	50 ohms unbalanced (coaxial)	Wind and ice conditions	Withstands:
VSWR	Less than 2:1 relative to a 50 ohm source (average dipole height of 25 feet.)		60-mph wind, 1/4 inch radial ice (wires fully extended, housing supported, and wires tied off at ground level.
Power handling capability	1 kw pep or average.		60-mph wind, no ice (wires fully extended and tied off at approximately 25 feet above ground.)
Directive gain	Similar to a half-wave dipole at the same effective height.		40-mph wind, 1/8 inch radial ice (wires fully extended and tied off at approximately 25 feet above ground.)
Radiation characteristics	Similar to a half-wave dipole at the same effective height.		
Physical:			
Input RF connector	Type N receptacle (UG-58A/U)		

13-3. Items Comprising an Operable Antenna, Transportable (Collins 637T-2)

NSN	Item	Dimensions (in)			Weight (lb)_	
		Qty	Height	Depth		Width
5895-00-909-1873	Antenna, transportable, (Collins 637T-2) kit consisting of: Antenna, transportable (Collins 637T-2)(Collins part No. 772-5477-002).	1	5	4	9	4
5895-00-247-0186	50-foot RG-58/U coaxial cable with type N plug on one end and phono plug on other end. (Collins part No. 776-9921-001)	1				

Section II. INSTALLATION

13-4. Site Selection

The Collins 637T-2 is adaptable to a wide variety of physical sites. However, the frequency of operation dictates the length of antenna elements; and this should be considered when selecting a site. For maximum antenna operating efficiency, locate the Collins 637T-2 at the center of a clear area; avoid location near any tall metal objects. After determining the location of the antenna, the erection of the antenna may proceed.

13-5. Erecting Procedure

Erect the antenna as follows:

- a. Be sure that that all wire is wound onto the reels.
- b. Set both wire length indicator pointers to zero by loosening the indicator clamp knobs, positioning the indicators to zero, and retightening the clamp knobs.
- c. Pull both wires out of the housing until the indicators indicate the desired frequency.

NOTE

For proper dipole operation, be sure that both indicators indicate the same frequency.

- d. Secure the wires at the desired length with the wire lock knobs (similar to binding posts) mounted on the antenna housing.

NOTE

The RF path from the transceiver to the antenna is through the coaxial cable, through the balun, to the wire lock knobs, and to the dipole elements.

- e. Connect the coaxial cable to the RF input connector on the antenna housing.

NOTE

The end of each wire is attached through a swivel to a length of nylon rope. This is the insulator as well as the ground stake attachment.

- f. Raise the antenna to the desired height by passing each rope over a tree limb, tower, or other

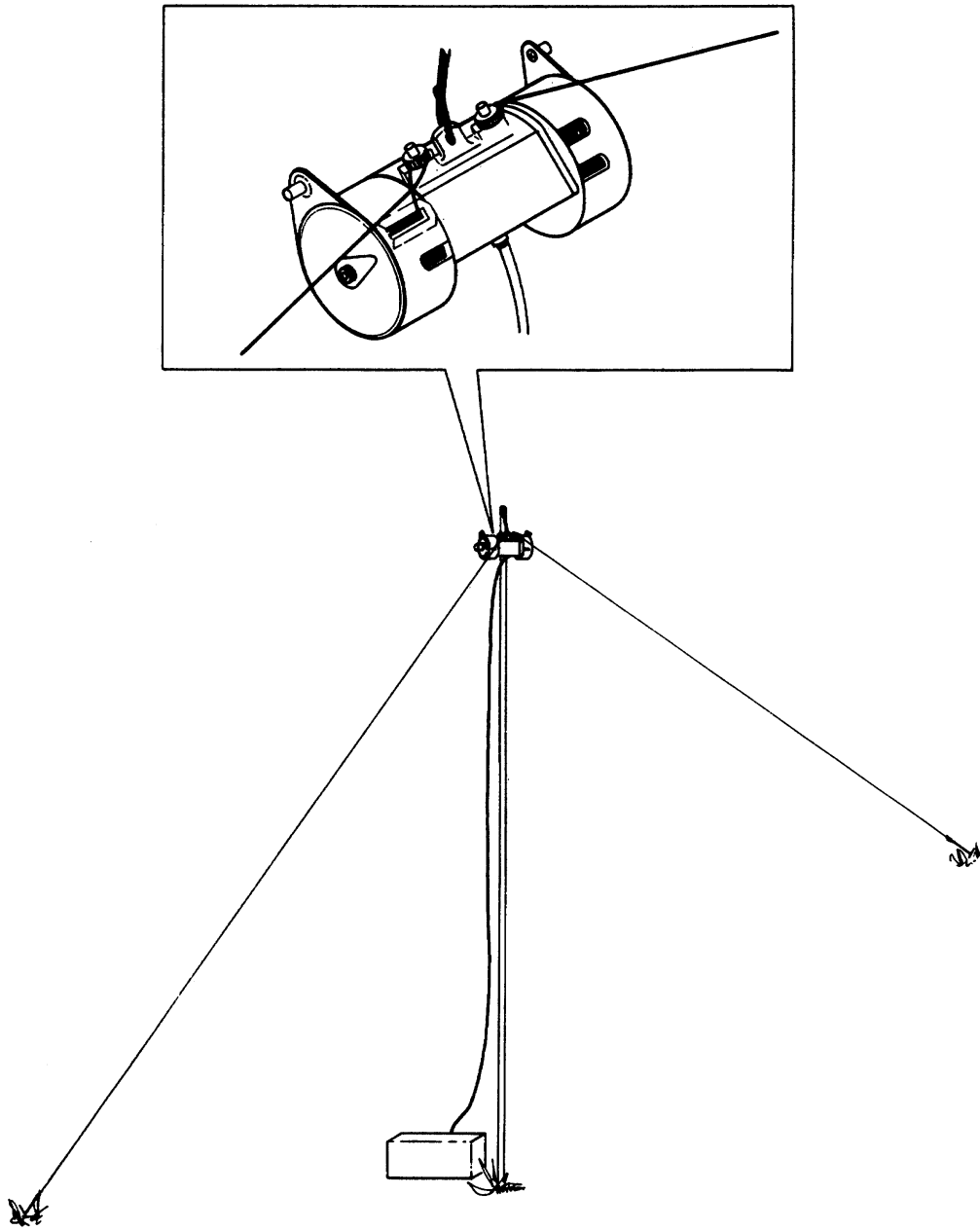

Figure 13-2. Antenna supported at housing.

TM 11-5820-554-12

vertical structure. Making a small coil of the rope will facilitate throwing it over the vertical structure.

NOTE

The antenna reel housing may also be secured to a single vertical support structure, and the elements tied off at ground level with the guy ropes (fig. 13-2). Under certain environmental conditions, such as high wind and/or heavy ice loading, this method is more desirable.

13-6. Lowering Procedure

Lower the antenna as follows:

- a. Untie the ropes and lower the antenna to the ground.
- b. Disconnect the coaxial cable from the antenna housing.
- e. Loosen the wire lock knobs and free the wires.

WARNING

- Keep fingers clear of the wire as it is wound on to the reels.
- d. Wind the wires onto the reels.
 - e. Coil and tie the ropes.

Section III. OPERATION

13-7. General

The Collins 637T-2 consists of two reels of phosphor-bronze wire stored in a cylindrical housing. Prior to unreeling the wires, set both wire length indicator pointers to zero.

13-8. Operating Frequency Selection

For operation at a particular frequency, each wire is pulled out of the housing to the correct length as

indicated by a dial that is calibrated in frequency. Figure 13-3 shows frequency versus per side wire length. The wires are secured at the desired length with the wire lock knobs mounted in the housing. The end of each wire is attached through a swivel to a length of nylon rope. The antenna is then raised to the desired height by passing each rope over a tree limb, tower, or other vertical structure. Connection to the equipment is made with standard 50-ohm coaxial cable (before raising).

Section IV. OPERATING PRINCIPLES

13-9. General

The Collins 637T-2 operates as a conventional half-wave dipole (fig. 13-4). The radiation characteristics of a dipole antenna are dependent on its height above ground. Figure 13-5 shows calculated elevation plane patterns at an average height of 25 feet.

13-10. Impedance Matching The 50-ohm unbalanced transmission line is matched into the

balanced dipole circuit by a ferrite balun contained in the antenna housing. Figure 13-4 shows the balun and antenna connections.

13-11. Gain

The Collins 637T-2 provides good gain on path lengths varying from 0 to approximately 1,000 miles. Longer paths require multiple hops. Figure 13-5 shows the field intensity radiation patterns to be expected for the various frequencies.

Section V. MAINTENANCE

13-12. General

The Collins 637T-2 requires a minimum of maintenance. Periodically, the antenna should be disassembled, and all gears washed with soap and water.

13-13. Disassembly Procedure (fig. FO-2)

To disassemble the antenna, refer to the exploded view in figure FO 2 and proceed as follows:

- a. Remove the retaining ring (9) from the rod assembly (12) at either end of the antenna.
- b. Remove the three flat washers (10).
- c. Unscrew and remove the clamp indicator knob (11).
- d. Remove the dial indicator assembly (13, 14).
- e. Remove the dial assembly (21, 22).

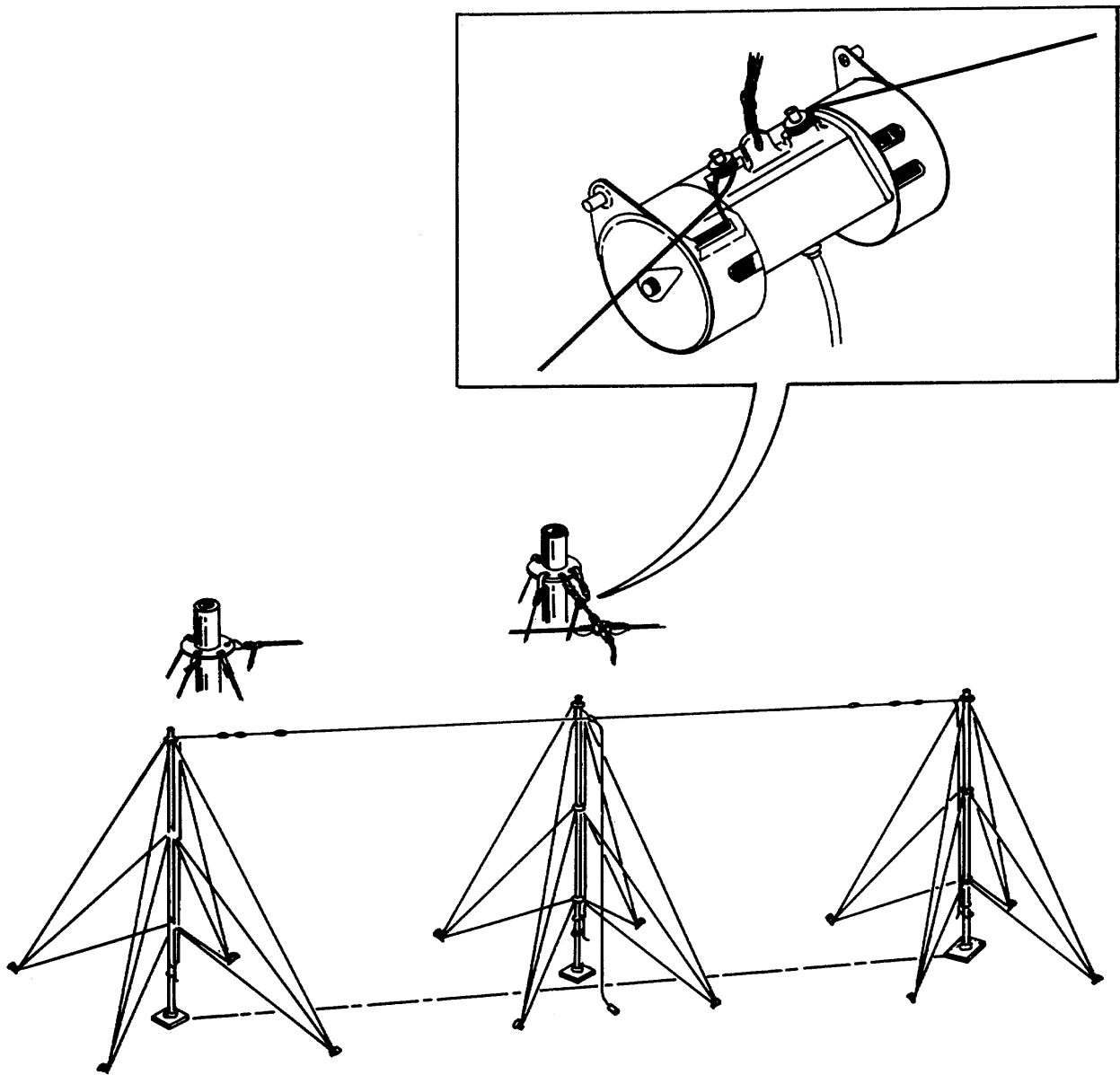

NOTE: REFER TO TM-5820-256-10 FOR DETAILS ON INSTALLATION OF MAST ASSEMBLIES.

ELOD060

Figure 13-2.1. Typical Three Mast Installation Collins 637T-2 2 Antenna Assembly.

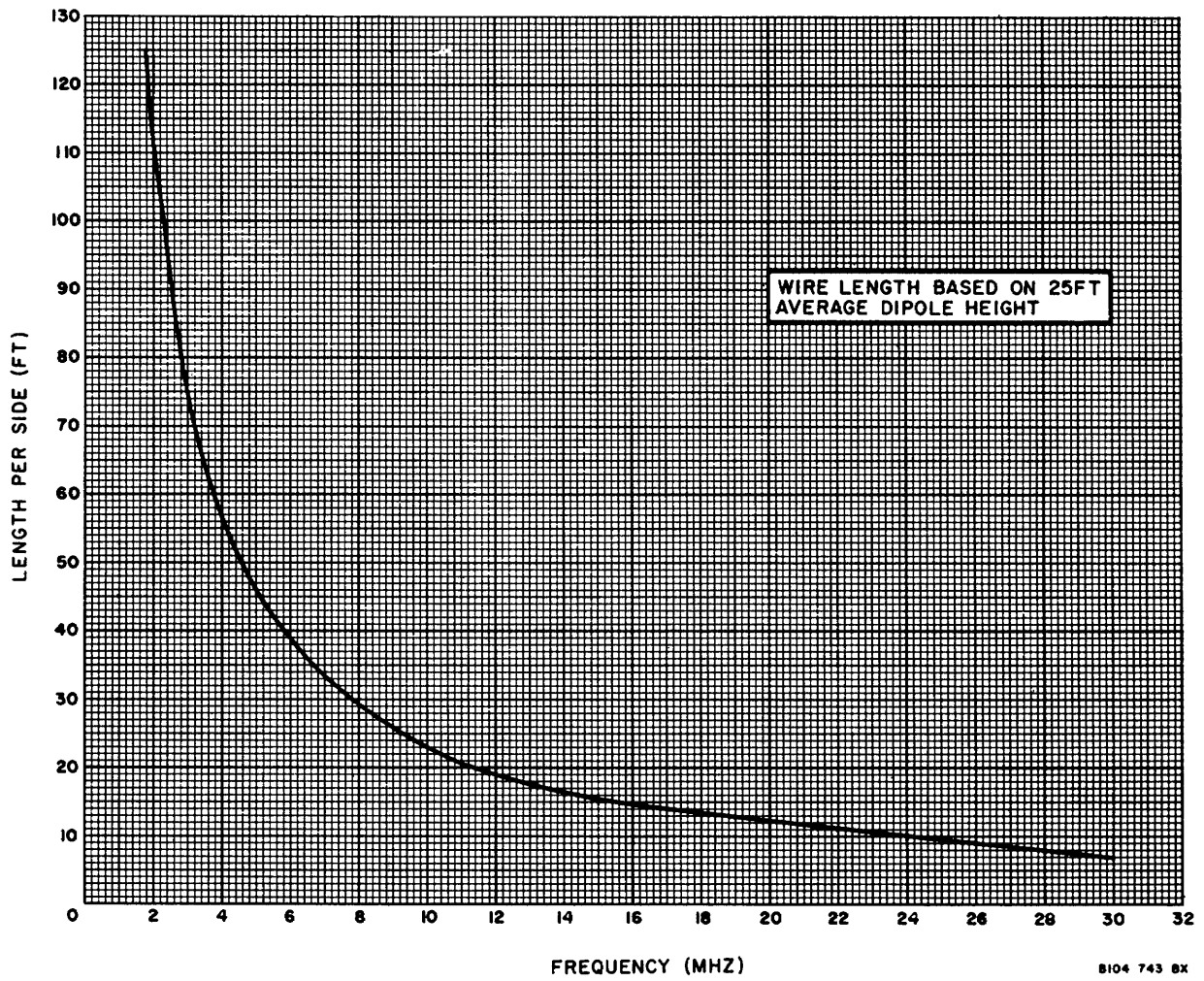

B104 743 BX

ELOD0042

Figure 13-3. Frequency versus per side wire length.

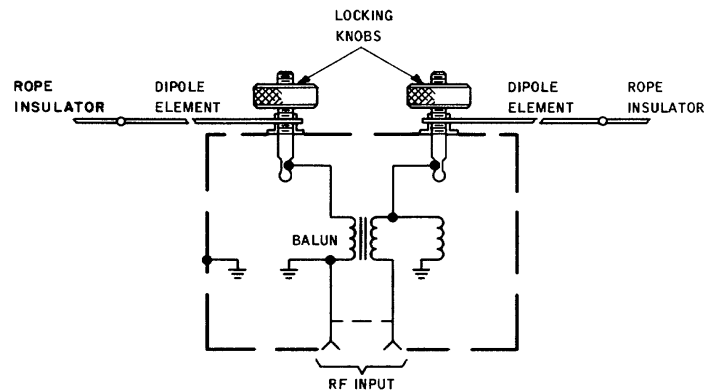

ELOD0043

Figure 13-4. Collins 637T-2 schematic diagram.

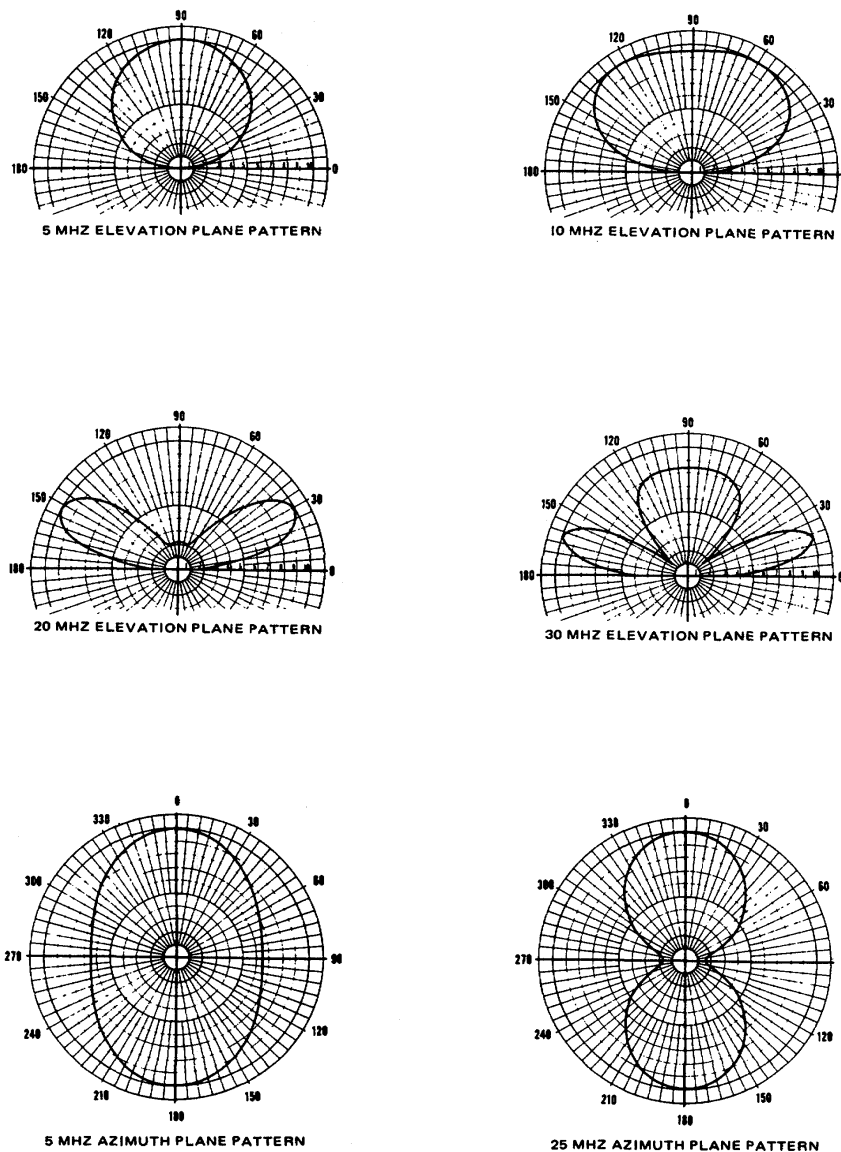

EL000044

Figure 13-5. Collins 637T-2 field intensity radiation patterns, average ground.

f. Remove the spur gear (18, 19) and pinion gear (25) from the antenna reel (26).

g. Lift the antenna reel free of the molded housing (27).

h. Remove the two nuts (7 and 8) securing the molded housing to the antenna and remove the molded housing.

NOTE

The other antenna reel assembly may be disassembled by repeating *a* through *h* above.

i. Remove the four screws (49) that hold the electrical connector (53) to the balun cover (54).

j. Remove the four screws (47) that secure the balun to the balun cover.

k. Remove the balun from the terminal studs (36) by unsoldering the two wires from the terminal studs.

13-14. Reassembly Procedure

Reassemble the antenna by performing the disassembly procedure in reverse. Reset the dial indicators to zero.

14-1. Microphone, Dynamic M-127/FRC-93 (Collins MM-1)

The M-127/FRC-93 is a pressure-operated dynamic microphone. It has a frequency response from 200 to 10,000 Hz. A dashboard bracket is supplied with the microphone. When the microphone is removed from the dashboard bracket, it is in position for instant transmission. It has an output level of -48 db.

14-2. Microphone Headset (Collins MM-)

The Collins MM-2 is comprised of a high impedance reluctance microphone and a single earphone which can be used in either a fixed station installation or with a mobile unit. It has a frequency response from 100 to 7,000 Hz and an output level of -50 db. It weighs 3 1/2 ounces and is built to withstand the strenuous demands of daily mobile operation. The microphone boom has a 360-degree adjustment, making it possible to angle the mike to the best pickup position. It is equipped with both mike and phone

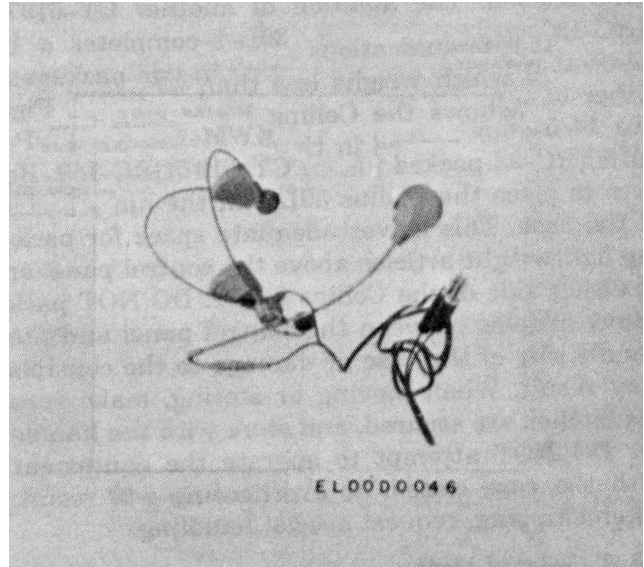

Figure 14-2. Collins MM-2 microphone headset.

14-3. Power Cable (Collins 440E-1)

The Collins 440E-1 is similar to the cable supplied with the Collins 351D-2. This cable is used to connect the Collins KWM-2/2A with the PP - 4765/GRC-159(V) or the Collins MP-1, when the mobile mount is not used.

14-4. Case, Electrical Equipment CY-6197/ GRC-159 (Collins CC-2)

a. *Description and Use.* The CY - 6197/GRC-159 is an especially built carrying case for the compo-
POWER CABLE XXX
(COLLINS MODEL 440E -I)

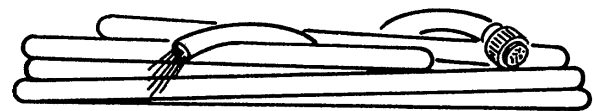

EL0D0047

Figure 14-3. Power cable Collins 440E-1.

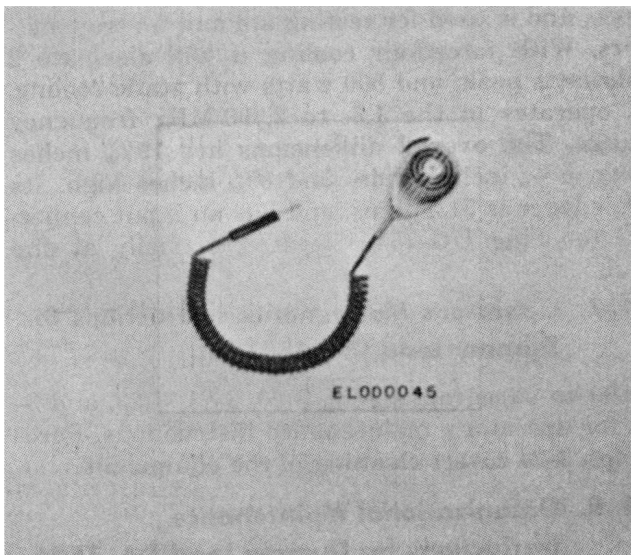

Figure 14-1. Microphone, Dynamic M-127/FRC - 9 (Collins MM-1).

TM 11-5820-554-12

nents of a portable ssb or cw station. It will accommodate either the Collins 30L-1 or the Collins KWM-2/2A with the PP-3990/FRC-93. Adequate space is included for a coiled antenna, a microphone, a headset, and a key. Also a loudspeaker is included in the PP-3990/FRC - 93. The complete package (CY-6197/GRC-159, Collins KWM-2/2A, and PP-990/FRW93) makes up a highly portable, 100-watt ssb or cw communications station. The addition of another CY-6197/ GRC-159 with the Collins 30L-1 completes a 1-kilowatt communications station in two packages, either of which weighs less than 50 pounds. Figure 14-5 shows the Collins KWM-2/2A and PP-3990/FRC-93 packed in the CY - 6197/GRC-159. Be sure to place the Collins 30L-1 in the hinged side of the case. This leaves adequate space for packing lightweight articles above the control panel or at either side of the Collins 30L-1. DO NOT pack heavy articles between the control panel and the handle side of the case or damage to the controls may result. When moving or storing, make sure the latches are secured, and store with the handle up. DO NOT attempt to operate the equipment with the case closed, or overheating will result. When shipping, request special handling.

b. Tabulated Data.

Overall dimensions	21.5 inches long by 21
..... i	inches deep by 9.5 inches
.....	high.
Weight (empty)	9.5 lb.
Weight (packed with Collins	42 lb (approx).
KWM-2/2A and PP-3990/ FRC-93).	
Weight (packed with Collins	47.5lb(approx)
30-L)	

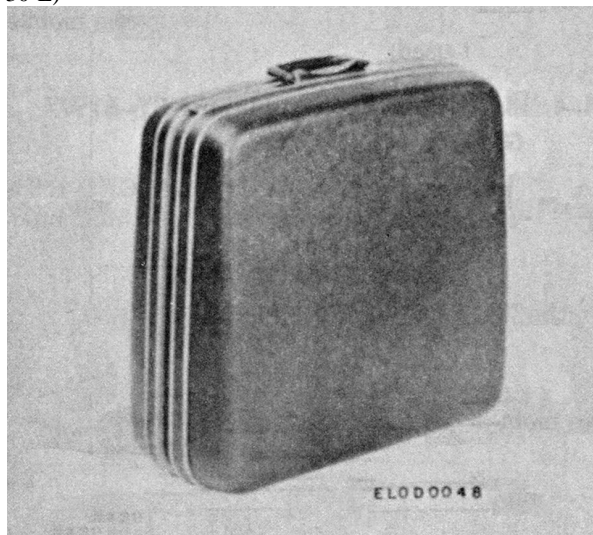

Figure 14-4. Case ,Electrical Equipment CY-6197/GRC-159.

14-5. Case, Electrical Equipment (Collins 3)

a. Description and Use. The Collins CC 3 is specially built carrying case for accessory components of a portable ssb or cw station. It will accommodate Control, Radio Set C -6118/FR-93 or C- 7515/FRC-93, Power Supplies PP-4765/GRC- 159 or Collins MP-1, a dipole antenna, and a 90- day supply of spare tubes, fuses, etc. This carrying case, packed with the desired selection of accessories, the CY - 6197/GRC - 159 (C CC- 2) with KWM-2/ 2A/PP-3990/FRC-93 combination, and the Collins CC- with the Collins 30L-1, makes up a completely versatile 1-kw station arrangement. Either fixed portable operation with complete station facilities or any kind of mobile operation may be planned. The total weight of any one of the three cases, packed in any choice of equipment, is less than 50 pounds. Figures 14 6 and 14-7 show the Collins CC-2 packed with Control, Radio Set 7515/FR C- 93 (Collins 312B-5) and either Power Supply PP 4765/GRC-159 or the Collins MP-1.

b. Tabulated Data.

Overall dimensions	21.5 inches long by 21
.....	inches deep by 9.5 inches
.....	high.
Weight (empty)	10 pounds.
Weight (packed with Collins	41 pounds (approx).
312B - 15, PP - 4765/GRC-,	
antenna, and 90-day spares).	
Weight (packed with Collins	36 pounds (approx).
312B-4/5, Collins MP-1, antenna,	
and 90-day spares).	

14-6. Load, Dummy DA-75/U

Load, Dummy DA-75/U employs resistive impedance, and is used for testing am and fm transmitters. With forced-air cooling it will dissipate 2 kilowatts peak, and 500 watts with static cooling. It operates in the 1.3- to 2, 700-MHz frequency range. The overall dimensions are 19 7/16 inches long, 5 5/16 inches wide, and 8 7/16 inches high. Its impedance is 51.5 ohms, and has an input connector for Plug UG-154/U located coaxially at one end.

14-7.Operator's Maintenance Instructions for Dummy Load DA-75/U

Refer to paragraphs 3-19. 3-20, 3-21, 3-23, and 24 for operator's maintenance instructions. Paragraph 3-24 covers cleaning of the equipment.

14-8. Organizational Maintenance Instructions for Dummy Load DA-75/U

Refer to paragraph 3-25 through 3-28 for organizational maintenance instructions. Paragraph 29 covers touchup painting.

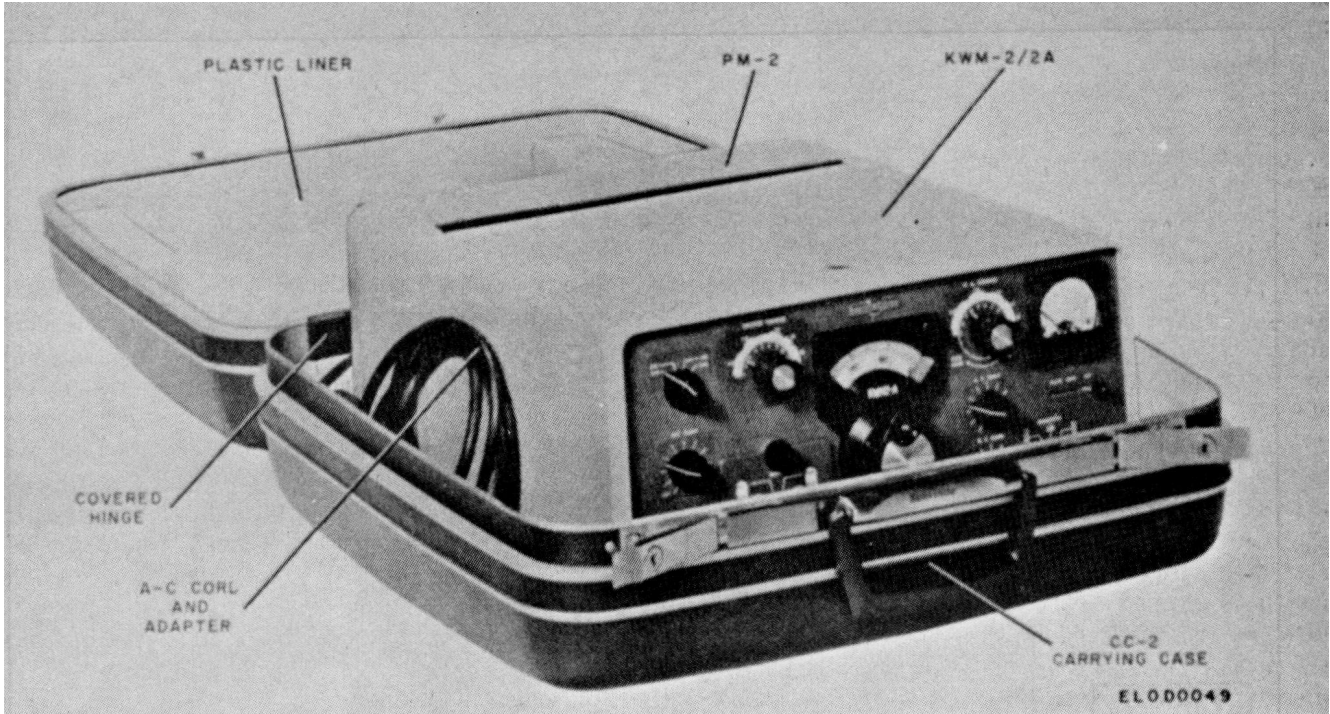

Figure 14-5. Collins KWM-2/2A and PP- 3990/FRC-93 packed in CY-6197/GRC-159.

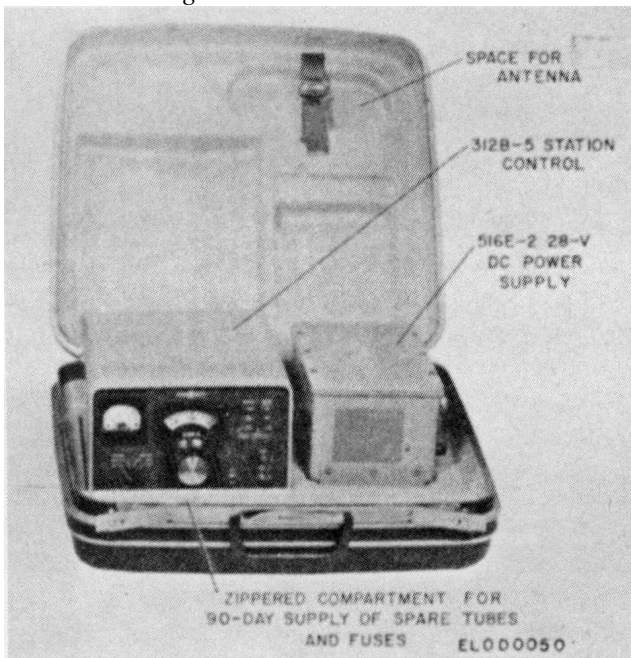

Figure 14-6. Collins CC-3 packed with Collins 312B-5 and PP-4765/GRC-159.

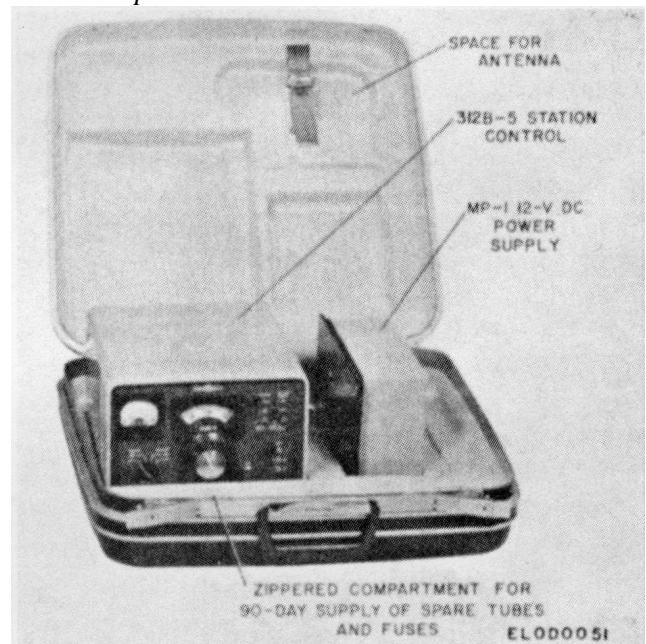

Figure 14-7. Collins CC-3 packed with Collins 312B-5 and PP-4765/GRC-159. Collins MP-1.

APPENDIX A REFERENCES

DA Pam 310-1	Consolidated Index of Army Publications and Blank Forms.
SB 38-100	Preservation, Packaging, Packing and Marking Materials, Supplies and Equipment Used by the Army.
TB 43-0118	Field Instructions for Painting and Preserving Electronics Command Equipment Including Camouflage Pattern Painting of Electrical Equipment Shelters.
TB SIG 222	Solder and Soldering.
TB SIG 291	Safety Measures to be Observed when Installing and Using Whip Antennas, Field Type Masts, Towers, Antennas, and Metal Poles that are used with Communications, Radar, and Direction Finder Equipment.
TB SIG 355-3	Depot Inspection Standard for Moisture and Fungus Resistant Treatment.
TM 11-5820-554-34-1	Direct Support and General Support Maintenance for Amplifier, Radio Frequency AM-3979/FRC-93 (Collins Model 30L-1) (NSN 5820-00-082-4081).
TM 11-5820-554-34-2	Direct Support and General Support Maintenance Manual: Control, Radio Set C-61181FRC-93 (NSN 5820-00-082-4082) and Control, Radio Set C-7515/FRC-93 (NSN 5820-00-702-2216).
TM 11-5820-554-34-3	Direct Support Maintenance Manual: Receiver-Transmitter, Radio RT-718/FRC-93 (Collins KWM-2/2A) (NSN 5820-00-082-4080).
TM 11-5820-554-34-4	Direct Support and General Support Maintenance Manual Power Supply PP-3990/FRC-93 (Collins PM-2) (NSN 5820-00-985-8171) Power Supply PP-4151/FRC-93 (Collins 516F2) (NSN 5820-00-034-4239) Power Supply PP-4765/GRC-159(V) (Collins 516E2) (NSN 6130-00-926-7805) and 12-Volt Input (Collins MP-1) (NSN 5820-00-034-4233).
TM 11-5820-554-34-5	Direct Support and General Support Maintenance Manual: Waters Q. Multipler Notch Filter, Model-340A (NSN 5915-00-911-2333).
TM 11-5820-554-34-6	Direct Support and General Support Maintenance Manual Regulator, Voltage CN-1146/FRC-93 (Sola Electric 36-189) (NSN 6110-00-930-0400).
TM 11-5820-554-34-7	Direct Support and General Support Maintenance Manual: Regulator, Voltage CN-1214/G (NSN 6110-00-832-4975).
TM 11-5820-554-34-8	Direct Support and General Support Maintenance Manual Filter, Radio Interference-1139/GRC-159(V) (NSN 5820-00-960-8526).
TM 11-5820-554-34-9	Direct Support and General Support Maintenance Manual for Coupler, CU-2004/U (Collins 180S-1) (NSN 5820-00-034-4241).
TM 11-6625-274-12	Operator's and Organizational Maintenance Manual: Test Sets, Electron Tube TV-7/U, TV-7A/U, TV-7B/U, and TV-7D/U.
TM 11-6625-654-14	Operator's, Organizational, Direct Support and General Support Maintenance, Repair Parts and Special Tools List (Including Depot Repair Parts and Special Tools List) for Multimeter AN/USM-223.
TM 38-750	The Army Maintenance Management Systems (TAMMS).
TM 750-244-2	Procedures for Destruction of Electronics Materiel to Prevent Enemy Use (Electronics Command).

APPENDIX C

MAINTENANCE ALLOCATION

SECTION I. INTRODUCTION

C-1. General

This appendix provides a summary of the maintenance operations for AN/FRC 93. It authorizes categories of maintenance for specific maintenance functions on repairable items and components and the tools and equipment required to perform each function. This appendix may be used as an aid in planning maintenance operations.

C-2. Maintenance Function.

Maintenance functions will be limited to and defined as follows:

a. Inspect. To determine the serviceability of an item by comparing its physical, mechanical, and/or electrical characteristics with established standards through examination.

b. Test. To verify serviceability and to detect incipient failure by measuring the mechanical or electrical characteristics of an item and comparing those characteristics with prescribed standards.

c. Service. Operations required periodically to keep an item in proper operating condition, i.e., to clean (decontaminate), to preserve, to drain, to paint, or to replenish fuel, lubricants, hydraulic fluids, or compressed air supplies.

d. Adjust. To maintain, within prescribed limits, by bringing into proper or exact position, or by setting the operating characteristics to the specified parameters.

e. Align. To adjust specified variable elements of an item to bring about optimum or desired performance.

f. Calibrate. To determine and cause corrections to be made or to be adjusted on instruments or test measuring and diagnostic equipment used in precision measurement. Consists of comparisons of two instruments, one of which is a certified standard of known accuracy, to detect and adjust any discrepancy in the accuracy of the instrument being compared.

g. Install. The act of emplacing, seating, or fixing into position an item, part, module (component or assembly) in a manner to allow the proper functioning of the equipment or system.

h. Replace. The act of substituting a serviceable like type part, subassembly, or module (component or assembly) for an unserviceable counterpart.

i. Repair. The application of maintenance services (inspect, test, service, adjust, align, calibrate, replace) or other maintenance actions (welding, grinding, riveting, straightening, facing, remachining, or resurfacing) to restore serviceability to an item by correcting specific damage, fault, malfunction, or failure in a part, subassembly, module (component or assembly), end item, or system.

j. Overhaul. That maintenance effort (service/action) necessary to restore an item to a completely serviceable/operational condition as prescribed by maintenance standards (i.e., DM. WR) in appropriate technical publications. Overhaul is normally the highest degree of maintenance performed by the Army. Overhaul does not normally return an item to like new condition.

k. Rebuild. Consists of those services/actions necessary for the restoration of unserviceable equipment to a like new condition in accordance with original manufacturing standards. Rebuild is the highest degree of material maintenance applied to Army equipment. The rebuild operation includes the act of returning to zero those age measurements (hours, miles, etc.) considered in classifying Army equipments/components.

C-3. Column Entries.

a. Column 1, Group Number. Column 1 lists group numbers, the purpose of which is to identify components, assemblies, subassemblies, and modules with the next higher assembly.

b. Column 2, Component/Assembly. Column 2 contains the noun names of components, assemblies, subassemblies, and modules for which maintenance is authorized.

c. Column 3, Maintenance Functions. Column 3 lists the functions to be performed on the item listed in column 2. When items are listed without maintenance functions, it is solely for purpose of having the group numbers in the MAC and RPSTL coincide.

d. Column 4, Maintenance Category. Column 4 specifies, by the listing of a "work time" figure in the

appropriate subcolumn(s), the lowest level of maintenance authorized to perform the function listed in column 3. This figure represents the active time required to perform that maintenance function at the indicated category of maintenance. If the number or complexity of the tasks within the listed maintenance function vary at different maintenance categories, "work time" figures will be shown for each category. The number of task-hours specified by the "work time" figure represents the average time required to restore an item (assembly, subassembly, component, module, end item or system) to a serviceable condition under typical field operating conditions. This time includes preparation time, troubleshooting time, and quality assurance/quality control time in addition to the time required to perform the specific tasks identified for the maintenance functions authorized in the maintenance allocation chart. Sub columns of column 4 are as follows:

- C—Operator/Crew
- O—Organizational
- F—Direct Support
- H—General Support
- D—Depot

e. Column 5, Tools and Equipment. Column 5 specifies by code, those common tool sets (not individual tools) and special tools, test, and support equipment required to perform the designated function.

f. Column 6, Remarks. Column 6 contains an alphabetic code which leads to the remark in section IV, Remarks, which is pertinent to the item opposite the particular code.

C-4. Tool and Test Equipment Requirements (Sec III).

a. Tool or Test Equipment Reference Code. The numbers in this column coincide with the numbers used in the tools and equipment column of the MAC. The numbers indicate the applicable tool or test equipment for the maintenance functions.

b. Maintenance Category. The codes in this column indicate the maintenance category allocated the tool or test equipment.

c. Nomenclature. This column lists the noun name and nomenclature of the tools and test equipment required to perform the maintenance functions.

d. National/NATO Stock Number. This column lists the National/NATO stock number of the specific tool or test equipment.

e. Tool Number. This column lists the manufacturer's part number of the tool followed by the Federal Supply Code for manufacturers (5- digit) in parentheses.

C-5. Remarks (Sec IV).

a. Reference Code. This code refers to the appropriate item in section II, column S.

b. Remarks. This column provides the required explanatory information necessary to clarify items appearing in Sec II.

(Next printed page is C-3.)

TM 11-5820-554-12

**SECTION II. MAINTENANCE ALLOCATION CHART
FOR
RADIO SET AN/FRC-93(V)**

(1) GROUP NUMBER	(2) COMPONENT/ASSEMBLY	(3) MAINTENANCE FUNCTION	(4) MAINTENANCE CATEGORY					(5) TOOLS AND EQPT	(6) REMARKS
			C	O	F	H	D		
00	RADIO SET AN/FRC-93 COLLINS CFP-101 P/N 522-3864-00								

**SECTION III. MAINTENANCE ALLOCATION CHART
FOR
AMPLIFIER, RF AM-3979/FRC-93**

(1) GROUP NUMBER	(2) COMPONENT ASSEMBLY	(3) MAINTENANCE FUNCTION	(4) MAINTENANCE CATEGORY					(5) TOOLS AND EQUIPMENT	(6) REMARKS
			C	O	F	H	D		
00	AMPLIFIER, RF AM-3979/FRC-93 Collins Model 30L-1.), P/N 522-2375-00 NOTE Direct Support (F) level maintenance operations for fixed plant equipment located OCONUS, will be performed by off-site (Area Maintenance and Supply Facility, AMSF) personnel.	Inspect Test Test Service Adjust Align Replace Re pair Repair Overhaul		0.2 0.2 0.2 1.0 1.0	0.5 0.5 2.0			1,2 1 thru 12 2 1 thru 12 1 thru 12 1,2 1,3 1 thru 12 1 thru 12	A B

**SECTION IV. TOOL AND TEST EQUIPMENT
REQUIREMENTS
FOR
AMPLIFIER. RF AM-3979/FRC-93**

TOOL OR TEST EQUIPMENT REF CODE	MAINTENANCE CATEGORY	NOMENCLATURE	NATIONAL/NATO STOCK NUMBER	TOOL NUMBER
1	O,F,H,D	MULTIMETER AN/USM-223	6625-00-999-7465	
2	O,F,H,D	TOOL KIT, ELECTRONIC EQUIPMENT TK-101/G	5180-00-064-5178	
3	F,H,D	TOOL KIT, ELECTRONIC EQUIPMENT TK-105/G	5180-00-610-8177	
4	F,H,D	DUMMY LOAD, ELECTRICAL DA-75/U	6625-00-177-1639	
5	F,H,D	TEST SET, RADIO AN/URM-120	6625-00-813-8430	
6	F,H,D	OSCILLOSCOPE AN/USM-281(*)	6625-00-053-3112	
7	F,H,D	TEST "T. RADIO AN/GRM-33A	6625-00-893-4913	
8	F,H,D	MULTIMETER NE-26(*)/U	6625-00-913-9781	
9	F,H,D	TRANSCEIVER RT-718/FRC-93	5820-00-082-4080	
10	F,H,D	POWER SUPPLY PP-4151/FRC-93	5820-00-034-4239	
11	F,H,D	CONTROL, RADIO SET C-6118/FRC-93	5820-00-082-4082	
12	F,H,D	TOOL KIT, ELECTRONIC EQUIPMENT TK-100/G	5180-00-605-0079	

SECTION V. REMARKS

REFERENCE CODE	REMARKS
A B	Equipment operation, continuity checks, and transconductance of tubes. Repair shorts, opens, replace tubes.

**SECTION VI. MAINTENANCE ALLOCATION CHART
FOR
CONTROL, RADIO SET C-6118/FRC-93**

(1) GROUP NUMBER	(2) COMPONENT ASSEMBLY	(3) MAINTENANCE FUNCTION	(4) MAINTENANCE CATEGORY					(5) TOOLS AND EQPT	(6) REMARKS
			C	O	F	H	D		
00	<p>CONTROL, RADIO SET -6118/FRC-93 Collins Model 312B-4, P/N 522-1167-00</p> <p>Direct Support (F) level maintenance operations for fixed plant equipment ;Repair0.5 located OCONUS, will be performed by off-site (Area Maintenance and Supply Facility, A F) personnel.</p>	<p>Inspect Test Test Service Replace Repair Repair Overhaul</p>		<p>0.2 0.2 0.2 05</p>	<p>1.0 2.0</p>			<p>3.0</p>	<p>2.5 1 thru 13 5 2.5 2.5 1 thru 13 1 thru 13</p> <p>A B</p>

**SECTION VII. TOOL AND TEST EQUIPMENT REQUIREMENTS
FOR
CONTROL, RADIO SET C-6118/FRC-93**

TOOL OR TEST EQUIPMENT REF CODE	MAINTENANCE CATEGORY	NOMENCLATURE	NATIONAL/NATO STOCK NUMBER	TOOL NUMBER
1	F,H,D	COUNTER, ELECTRONIC, DIGITAL READOUT AN/USM-207A	6625-00-044-3228	
2	O,F,H,D	MULTIMETER AN/USM-223	6625-00-999-7465	
3	F,H,D	MULTIMETER ME-26(*)/U	6625-00-913-9781	
4	F,H,D	TOOL UT, ELECTRONIC EQUIPMENT TK-100/G	5180-00-605-0079	
5	O,F,H,D	TOOL KIT, ELECTRONIC EQUIPMENT TK-101/G	5180-00-064-5178	
6	F,H,D	TEST SEJ, RADIO AN/URM-120	6625-00-813-8430	
7	F,H,D	DUMMY LOAD, ELECTRICAL DA-75/U	6625-00-177-1639	
8	F,H,D	TRANSCEIVER RF-718/FRC-93	5820-00-082-4080	
9	F,H,D	POWER SUPPLY PP-4151/FRC-93	5820-00-034-4239	
10	F,H,D	VOLTMETER, ELECTRONIC ME-30(*)/U	6625-00-643-1670	
11	F,H,D	AMPLIFIER, RF AM-3979/FRC-93	5820-00-082-4081	
12	F,H,D	TEST SET, RADIO AN/OR - GRM-33A	6625-00-893-4913	
13	F,H,D	TOOLKIT,ELECTRONICEQUIPMENT TK-105/G	5180-00-610-8177	

SECTION VIII. REMARKS

REFERENCE CODE	REMARKS
A B	Continuity checks. Repair shorts, opens, replace running spare parts.

**SECTION IX. MAINTENANCE ALLOCATION CHART
FOR
CONTROL, RADIO SET C-7515/FRC-93**

(1) GROUP NUMBER	(2) COMPONENT ASSEMBLY	(3) MAINTENANCE FUNCTION	(4) MAINTENANCE CATEGORY					(5) TOOLS AND EQPT	(6) REMARKS		
			C	O	F	H	D				
00	CONTROL, RADIO SET C-7515/PRC-93, COLLINS MODEL 312B-5, P/N 522-1668-00	Inspect		0.2							
		Test		0.2							
		Test				1.0			2,4,5 1 thru 16	A	
		Service		0.1					5		
		Replace		0.3					2,5		
01	DIRECTIONAL COUPLER, P/N 543-8118-004	Repair		0.5					2,4,5 1 thru 16	B	
		Repair				2.0			1 thru 16		
		Overhaul					4.0		1 thru 16		
02	OSCILLATOR, VARIABLE FREQUENCY 70 kHz, P/N 522-1093-00 NOTE Direct Support (F) level maintenance operations for fixed plant equipment located OCONUS, will be performed by off-site (Area Maintenance and Supply Facility, AMSF) personnel.	Inspect		0.2							
		Test		0.2							
		Test				0.5				2,5 1 thru 16	A
		Replace				0.1				2,5 1 thru 16	
02		Repair				3.0					
		Inspect				0.5					
		Test				0.5				1 thru 16	
02		Replace				1.0				1 thru 16	
		Repair						3.0		1 thru 16	C

TM 11-5820-554-12

**SECTION X. TOOL AND TEST EQUIPMENT REQUIREMENTS
FOR
CONTROL, RADIO SET C-7515/FRC-93**

TOOL OR TEST EQUIPMENT REF CODE	MAINTENANCE CATEGORY	NOMENCLATURE	NATIONAL/NATO STOCK NUMBER	TOOL NUMBER
1	F,H,D,	COUNTER, ELECTRONIC, DIGITAL READOUT AN/USM-207A	6625-00-044-3228	
2	O,F,H,D	MULTIMETER AN/USM-223	6625-00-999-7465	
3	F,H,D	MULTIMETER NE-26(*)/U-	6625-00-913-9781	
4	O,F,H,D	TEST SET, ELECTRON TUBE TV-7D/U	6625-00-820-0064	
5	F,H,D	TOOL KIT, ELECTRONIC EQUIPMENT TK-101/G	5180-00-064-5178	
6	F,H,D	TOOL KIT, EEELECTRONIC EQUIPMENT TK-100/G	5180-00-605-0079	
7	F,H,D	TEST SET, RADIO AN/URM-120	6625-00-813-8430	
8	F,H,D	TRANSCEIVER RT-718/FRC-93	5820-00-082-4276	
9	F,H,D	POWER SUPPLY PP-4151/FRC-93	5820-00-031-4239	
10	F,H,D	VOLTMETER ELECTRONIC ME-30(*)/U	6625-00-643-1670	
11	F,H,D	AMPLIFIER RF AM-3979/FRC-93	5820-00-082-4081	
12	F,H,D	TEST SET, RADIO AN/GRM-33A	6625-00-893-4913	
13	F,H,D	DUMMY BY LOAD, ELECTRICAL DA-75/U	6625-00-177-1639	
14	F,H,D	CONTROL, RADIO SET C-6118/FRC-93	5820-00-082-4082	
15	F,H,D	RF, LOAD 51.5 OHM, BIRD 888		
16	F,H,D	TOOL KIT,ELECTRONICEQUIPMENT TK-105/G	5180-00-610-8177	

SECTION XI. REMARKS

REFERENC E CODE	REMARKS
A B C	Continuity checks, transconductance, and equipment operation. Repair shorts, opens, Replace running spare parts. Return to manufacturer for repair.

**SECTION XIII. TOOL AND TEST EQUIPMENT REQUIREMENTS
FOR
CONTROL, RADIO SET C-7515/FRC-93**

TOOL OR TEST EQUIPMENT REF CODE	MAINTENANCE CATEGORY	NOMENCLATURE	NATIONAL/NATO STOCK NUMBER	TOOL NUMBER
1	O,F,H,D	MULTIMETER AN/USM-223	6625-00-999-7465	
2	F,H,D	OSCILLOSCOPE AN/USM-281(*)	6625-00-053-3112	
3	F,H,D	TOOL KIT, ELECTRONIC EQUIPMENT TK-100/G	5180-00-605-0079	
4	O,F,H,D	TOOL KIT, ELECTRONIC EQUIPMENT TK-101/G	5180-00-064-5178	
5	F,H,D	TOOL KIT, ELECTRONIC EQUIPMENT - TK-105/G	5180-00-610-8177	

SECTION XIV. REMARKS

REFERENCE CODE	REMARKS
A B	Continuity checks, Repair opens, shorts Replace running spares

**SECTION XV. MAINTENANCE ALLOCATION CHART
FOR
POWER SUPPLY PP-4151/FRC-93**

(1) GROUP NUMBER	(2) COMPONENT ASSEMBLY	(3) MAINTENANCE FUNCTION	(4) MAINTENANCE CATEGORY					(5) TOOLS AND EQPT	(6) REMARKS
			C	O	F	H	D		
00	POWER SUPPLY PP-4151/FRC-93.COLLINS MODEL 516F-2,P/N 522-1170-00 NOTE Direct Support (F) level maintenance operations for fixed plant equipment located OCONUS, will be performed by off-site (Area maintenance and Supply Facility, AMSF) personnel.	Inspect Teat Test Service Adjust Replace Repair Repairs Overhaul		0.2 0.2 0.2 0.1 0.2 0.2	1.0			1,3,5 1 thru 4 5 1,3,5 1, 3, 5 1,3,5 1 thru 6 1 thru 6	A B

**SECTION XVI. TOOL AND TEST EQUIPMENT REQUIREMENTS
FOR
POWER SUPPLY PP-4151/FRC-93**

TOOL OR TEST EQUIPMENT REF CODE	MAINTENANCE CATEGORY	NOMENCLATURE	NATIONAL/NATO STOCK NUMBER	TOOL NUMBER
1	O,F,H,D	MULTIMETER AN/USM-223	6625-00-999-7465	
2	F,H,D	OSCILLOSCOPE AN/USM-281(*)	6025-00-053-3112	
3	O,F,H,D	TEST SET, ELECTRON TUBE TV-7D/U	6625-00-820-0064	
4	F,H,D	TOOL KIT, ELECTRONIC EQUIPMENT TK-100/G	5180-00-605-0079	
5	O,F,H,D	TOOL KIT, ELECTRONIC EQUIPMENT TK-101/G	5180-00-064-5178	
6	F,H,D	TOOL KIT, ELECTRONIC EQUIPMENT TK-105/G	5180-00-610-8177	

SECTION XVII. REMARKS

REFERENCE CODE	REMARKS
A B	Continuity checks. Repair shorts, opens. Replace running spares parts.

**SECTION XIX. MAINTENANCE ALLOCATION CHART
FOR
POWER SUPPLY, COLLINS MODEL MP-1**

TOOL OR TEST EQUIPMENT REF CODE	MAINTENAN CE CATEGORY	NOMENCLATURE	NATIONAL/NATO STOCK NUMBER	TOOL NUMBER
1	O,F,H,D	MULTIMETER AN/USM-223	6625-00-999-7465	
2	F,H,D	OSCILLOSCOPE AN/USM-281(*)	6625-00-053-3112	
3	F,H,D	TEST SET, SEMICONDUCTOR DEVICE TS-1836(*)/U	6625-00-159-2263	
4	F,H,D	TOOL KIT, ELECTRONIC EQUIPMENT TK-100/G	5180-00-605-0079	
5	O,F,H,D	TOOL KIT, ELECTRONIC EQUIPMENT TK -101/G	5180-00--064-5178	
6	F,H,D	TOOL KIT,ELECTRONIC EQUIPMENT TK-105/G	5100-00-610-8177	

SECTION XX. REMARKS

REFERENCE CODE	REMARKS
A B	Continuity checks, Repair shorts, opens. Replace running spares.

**SECTION XIX. MAINTENANCE ALLOCATION CHART
FOR
POWER SUPPLY, COLLINS MODEL MP-1**

TOOL OR TEST EQUIPMENT REF CODE	MAINTENANCE CATEGORY	NOMENCLATURE	NATIONAL/NATO STOCK NUMBER	TOOL NUMBER
1	O,F,H,D	MULTIMETER AN/USM-223	6625-00-999-7465	
2	F,H,D	OSCILLOSCOPE AN/USM-281(*)	6625-00-053-3112	
3	F,H,D	TEST SET, SEMICONDUCTOR DEVICE TS-1836(*)/U	6625-00-159-2263	
4	F,H,D	TOOL KIT, ELECTRONIC EQUIPMENT TK-100/G	5180-00-605-0079	
5	O,F,H,D	TOOL KIT, ELECTRONIC EQUIPMENT TK -101/G	5180-00--064-5178	
6	F,H,D	TOOL KIT,ELECTRONIC EQUIPMENT TK-105/G	5100-00-610-8177	

SECTION XXIII. REMARKS

REFERENCE CODE	REMARKS
A	Continuity checks.
B	Repair opens, shorts. Replace running spare parts.

TM 11-5820-534-12

SECTION XXIV. MAINTENANCE ALLOCATION CHART
FOR
RECEIVER-TRANSMITTER, RADIO RT-718/FRC-93

(1) GROUP NUMBER	(2) COMPONENT ASSEMBLY	(3) MAINTENANCE FUNCTION	(4) MAINTENANCE CATEGORY					(5) TOOLS AND EQPT.	(6) REMARKS	
			C	O	F	H	D			
00	RECEIVER-TRANSMITTER, RADIO RT-718/FRC-93 COLLINS MODEL KWM 2 AND KWM-2A, P/N522-1792-00	Inspect Test Test Service Adjust Align Replace Repair Overhaul		0.1 0.3 0.3 1.0					9,14,18 1 thru 16 19,20,21 9,18 2,3,5,10, 13,17,18, 20 2,3,5,10, 13,17,18, 20 9,18 1 thru 22 1 thru 22	A
01	CABINET, RECEIVER 1A1 P/N 544-9745-005									
02	CHASSIS, SUBASSEMBLY P/N 544-9697-000 OR 545-9114-000									
0201	CABLE ASSEMBLY, TRANSCEIVER 1A2A1, P/N 544-9702-000									
0202	CHASSIS ELECTRICAL, BONDED 1A2A2 P/N 545-9113-000									
0203	OSCILLATOR, RADIO FREQUENCY 1A2A3, P/N 522-1093-000	Test Replace Repair			0.5 0.5			2.0	1 thru 22 18 1 thru 22	B
020301	SOCKET, ELECTRON TUBE ASSEMBLY 1A2A3A1, P/N 543-7322-000									
0204	RACK, SLUG ASSEMBLY 1A2A4, P/N 757-6574-001									
	NOTE Direct Support (F) level maintenance operations for fixed plant equipment located OCONUS will be performed by off-site (Area Maintenance and Supply Facility, AMSF) personnel.									

**SECTION XXV. TOOL AND TEST EQUIPMENT REQUIREMENTS
FOR**

RECEIVER-TRANSMITTER, RADIO RT-718/FRC-93

TOOL OR TEST EQUIPMENT REF CODE	MAINTENANCE CATEGORY	NOMENCLATURE	NATIONAL/NATO STOCK NUMBER	TOOL NUMBER
1	F, H, D	COUNTER, ELECTRONIC DIGITAL READOUT AN/USM-207A	6625-00-044-3228	
2	F, H, D	DUMMY LOAD ELECTRICAL DA-75/U	6625-00-177-1639	
3	F, H, D	GENERATOR, SIGNAL AN/GRM-50C	6625-00-003-3238	
4	F, H, D	GENERATOR SIGNAL AN/URM-127	6625-00-783-5965	
5	F, H, D	GENERATOR, SIGNAL AN/USM-205	6625-00-788-9672	
6	F, H, D	HEADSET, ELECTRICAL H-113/U	5965-00-504-6370	
7	F, H, D	LOUDSPEAKER, PERMANENT MAGNET LS-116/U	5965-00-179-2398	
8	F, H, D	MICROPHONE, DYNAMIC M-127/PRC-93	5965-00-034-4249	
9	O, F, H, D,	MULTIMETER AN/USM-223	6625-00-999-7465	
10	F, H, D	MULTIMETER ME-26D/U	6625-00-913-9781	
11	F, H, D	OSCILLOSCOPE AN/USM-281C	6625-00-106-9622	
12	F, H, D	POWER SUPPLY PP-4151/FRC-93	5820-00-034-4239	
13	F, H, D	RECEIVER, RADIO R-390A/URR	5820-00-538-7555	
14	O, F, H, D	TEST SET, ELECTRON TUBE TV-7D/U	6625-00-820-0064	
15	F, H, D	TEST SET, RADIO AN/GRM-33A	6625-00-893-4913	
16	F, H, D	TEST SET, RADIO AN/URM-120	6625-00-813-8430	
17	F, H, D	TOOL KIT, ELECTRONIC EQUIPMENT TK-105/G	5180-00-610-8177	
18	O, F, H, D	TOOL KIT, ELECTRONIC EQUIPMENT TK-101/G	5180-00-064-5178	
19	F, H, D	VOLTMETER, ELECTRONIC AN/URM-145	6625-00-973-3986	
20	F, H, D	VOLTMETER , ELECTRONIC ME-30E/U	6625-00-643-1670	
21	F, H, D	PAD, FORTY DECIBEL CN-248A/U		
22	F, H, D	TOOL KIT, ELECTRONIC EQUIPMENT TK-100/G	5180-00-605-0079	

TM 11-5820-554-12

SECTION XXVI. REMARKS

REFERENCE CODE	REMARK
A	Continuity checks.
B	Return to vendor for repair.

**SECTION XXVII. MAINTENANCE ALLOCATION CHART
FOR
FILTER, NOTCH/Q-MULTIPLIER, WATERS MODEL 340A**

(1) GROUP NUMBER	(2) COMPONENT ASSEMBLY	(3) MAINTENANCE FUNCTION	(4) MAINTENANCE CATEGORY					(5) TOOLS AND EQPT.	(6) REMARKS	
			C	O	F	H	D			
00	FILTER, NOTCH /Q-MULTIPLIER, WATERS MODEL 340A	Inspect Test Test Service Adjust Replace Repair Repair Overhaul		0.1 0.2 0.1 0.5 1.0 0.5	0.5 0.5 1.0 2.0			8.0	1, 2, 4 1 thru 9 1 1, 2, 4 1, 2, 4 1, 2, 4 1 thru 9 1 thru 9	A B C
	NOTE Direct Support (F) level maintenance operations for fixed plant equipment located OCONUS, will be performed by off-site (Area Maintenance and Supply Facility, AMSP) personnel.									

**SECTION XXVIII. TOOL AND TEST EQUIPMENT REQUIREMENTS
FOR**

FILTER, NOTCH/Q-MULTIPLIER, WATERS MODEL 340A

TOOL OR TEST EQUIPMENT REF CODE	MAINTENANCE CATEGORY	NOMENCLATURE	NATIONAL/NATO STOCK NUMBER	TOOL NUMBER
1	O, F, H, D	TOOL KIT, ELECTRONIC EQUIPMENT TK-101/G	5180-00-064-5178	
2	O, F, H, D	MULTIMETER AN-USM-223	6625-00-999-7465	
3	F, H, D	OSCILLOSCOPE AN/USM-281(*)	6625-00-053-3112	
4	O, F, H, D	TEST SET, ELECTRON TUBE TV-7D/U	6625-00-820-0064	
5	F, H, D	TOOL KIT, ELECTRONIC EQUIPMENT TK-100/G	5180-00-605-0079	
6	F, H, D	TOOL KIT, ELECTRONIC EQUIPMENT TK-105/G	5180-00-610-8177	
7	F, H, D	TRANSCIVER RT-718/FRC-93	5820-00-082-4080	
8	F, H, D	LOUDSPEAKER, PERMANENT MAGNET LS-116/U	5985-00-179-2398	
9	F, H, D	POWER SUPPLY PP-4151/FRC-93	5820-00-034-4239	

SECTION XXIX. REMARKS

REFERENCE CODE	REMARK
A	Equipment operation tube test.
B	Perform emergency wiring, repair as part of end item.
C	Tube replacement.

**SECTION XXIV. MAINTENANCE ALLOCATION CHART
FOR
RECEIVER-TRANSMITTER, RADIO RT-718/FRC-93**

(1) GROUP NUMBER	(2) COMPONENT ASSEMBLY	(3) MAINTENANCE FUNCTION	(4) MAINTENANCE CATEGORY					(5) TOOLS AND EQPT.	(6) REMARKS
			C	O	F	H	D		
00	REGULATOR, VOLTAGE CN-1146/FRC-93-, (SOLAR 36-18G)t	Inspect Test Test Service Replace Repair		0.2 0.3 0.1 0.3	1.0 1.5			1, 2 1 thru 9 2 1, 2 1 thru 9, 12 thru 14 1 thru 9	A
01	CIRCUIT BOARD ASSEMBLY (9-3687)	Overhaul Test Replace Repair			0.5 0.5	2.0	3.0	1 thru 9 1 thru 9 1 thru 11	
	NOTE								
	Direct Support (F) level maintenance for fixed plant equipment located OCONUS, will be performed by off-site (Area Maintenance and Supply Facility, A AM F) personnel.								

**SECTION XXXI. TOOL AND TEST EQUIPMENT REQUIREMENTS
FOR
REGULATOR, VOLTAGE CN-1146/FRC-93**

TOOL OR TEST EQUIPMENT REF CODE	MAINTENANCE CATEGORY	NOMENCLATURE	NATIONAL/NATO STOCK NUMBER	TOOL NUMBER
1	O, F, H, D	MULTIMETER AN/USM-223	6625-00-999-7465	
2	O, F, H, D	TOOL KIT, ELECTRONIC EQUIPMENT TK-101/G	5180-00-064-5178	
3	F, H, D	MULTI METER ME-26D/U	6625-00-913-9781	
4	F, H, D	OSCILLOSCOPE AN/USM-281(*)	6625-00-053-3112	
5	F, H, D	TOOL KIT, ELECTRONIC EQUIPMENT TK-105/G	5180-00-610-8177	
6	F, H, D	VOLTMETER (0-150 NON VA NE) IS-185	6625-00-405-6608	
7	F, H, D	ANALYZER, SPECTRUM TS-723C/U	6625-00-668-9418	
8	F, H, D	TEST SET, SEMICONDUCTOR DEVICES TS-1836(*)/U	6625-00-159-2263	
9	F, H, D	TOOL KIT, ELECTRONIC EQUIPMENT TK-100/G	5180-00-605-0079	
10	H, D	REPAIR KIT PRINTED WRING BOARD MK-772/U	5999-00-757-7042	
11	H, D	WISE, HOLDING PRINTED CIRCUIT BOARD		
12	F, H, D	TRANSFORMER, VARIABLE (VARIAC)	5950-00-235-2086	
13	F, H, D	LIGHT ASSEMBLY MX-1292/PAQ	6210-00-299-7480	
14	F, H, D	AMMETER ME-65A/U	6625-00-985-5251	

SECTION XXXII. REMARKS

REFERENCE CODE	REMARK
A	Continuity checks.

**SECTION XXXII. MAINTENANCE ALLOCATION CHART
FOR
REGULATOR, VOLTAGECN-1214/G**

(1) GROUP NUMBER	(2) COMPONENT ASSEMBLY	(3) MAINTENANCE FUNCTION	(4) MAINTENANCE CATEGORY					(5) TOOLS AND EQPT.	(6) REMARKS
			C	O	F	H	D		
00	REGULATOR, VOLTAGE CN-1214/G, SUPERIOR ELEC IE S25001	Inspect		0.2					A
		Test		0.2				1, 2	
		Test			1.0			1 thru 8	
		Service		0.1				1, 2	
		Replace		0.2				1, 2	
		Repair			1.5			1 thru 8	
		Overhaul					4.0	1 thru 12	
		Repair		0.5				1, 2	B
01	CIRCUIT BOARD ASSEMBLY (806046G1)			0.5				1 thru 8	
		Replace			0.5				
		Repair				1.0		1 thru 9	
	NOTE								
	Direct Support (F) level maintenance operations for fixed plant equipment located OCONUS, will be performed by off-site (Area. Maintenance and Supply Facility, AMSF) personnel.								

SECTION XXXIV. TOOL AND TEST EQUIPMENT REQUIREMENTS
FOR

REGULATOR, VOLTAGE CN-1214/G

TOOL OR TEST EQUIPMENT REF CODE	MAINTENANCE CATEGORY	NOMENCLATURE	NATIONAL/NATO STOCK NUMBER	TOOL NUMBER
1	O, F, H, D	MULTIMETER AN/USM-223	6625-00-999-7465	
2	O, F, H, D	TOOL KIT, ELECTRONIC EQUIPMENT TK-101/G	5180-00-064-5178	
3	F, H, D	MULTIMETER ME-25D/U	6625-00-913-9781	
4	F, H, D	OSCILLOSCOPE AN/USM-281(*)	6625-00-228-2201	
5	F, H, D	TOOL KIT, ELECTRONIC E QUIPMENT TK-105/G	5180-00-610-8177	
6	F, H, D	VOLT METER (0-150 V NON VANE IS-185	6625-00-405-6608	
7	F, H, D	ANALYZER, SPECTRUM TB-723C/U	6625-00-668-9418	
8	F, H, D	TEST SET, SEMICONDUCTOR DEVICES TS-1836(*)/	6625-00-159-2263	
9	H, D	REPAIR KIT, PRINTED WIRING BOARD MK -772/U	5999-00-757-7042	
10	D	AMMETER ME-65A/U	6625-00-985-5251	
11	F, H, D	TOOL KIT, ELECTRONIC EQUIPMENT TK-100/G	5180-00-605-0079	
12	F, H, D	VARIABLE TRANSFORMER	5950-00-235-2086	

SECTION XXV. REMARKS

REFERENCE CODE	REMARK
A	Continuity checks.
B	By replacement of fuses, lamps, and lenses.

**SECTION XXXVI. MAINTENANCE ALLOCATION CHART
FOR
Coupler, Antenna CU-2004/U**

(1) GROUP NUMBER	(2) COMPONENT ASSEMBLY	(3) MAINTENANCE FUNCTION	(4) MAINTENANCE CATEGORY					(5) TOOLS AND EQPT.	(6) REMARKS
			C	O	F	H	D		
00	Coupler, Antenna CU-2004/U, Collins Model 180S-1, P/N 522-0651-00	Inspect Test Test Service Replace Repair Repair Overhaul		0.2 0.2 0.1 0.2 0.5	1.0 1.5			2, 5 1 thru 11 5 2, 5 2, 5 1 thru 11 1 thru 12	A B
	Note Direct Support (F) level Maintenance operations for fixed plant equipment located OCONUS, will be performed by off-site (Area Maintenance and Supply Facility, AMSF) personnel								

**SECTION XXXVII. TOOL AND TEST EQUIPMENT REQUIREMENTS
FOR**

COUPLER, ANTENNA CU-2004/U

TOOL OR TEST EQUIPMENT REF CODE	MAINTENANCE CATEGORY	NOMENCLATURE	NATIONAL/NATO STOCK NUMBER	TOOL NUMBER
1	F, H, D	BRIDGE, CAPACITANCE-INDUCTANCE-RESISTANCE AN/URM-90	6625-00-534-7458	
2	O, F, H, D	MULTIMETER AN/USM-223	6625-00-999-7465	
3	F, H, D	MULTIMETER ME-26(*)/U	6625-00-913-9781	
4	F, H, D	TOOL KIT, ELECTRONIC EQUIPMENT TK-100/G	5180-00-605-0079	
5	O, F, H, D	TOOL KIT, ELECTRONIC E EQUIPMENT TK-101/G	5180-00-064-5178	
6	F, H, D	DUMMY LOAD, ELECTRICAL DA-487/U		
7	F, H, D	TEST BET, RADIO AN/URM-120	6625-00-813-8430	
8	F, H, D	TOOL KIT, ELECTRONIC EQUIPMENT TK-105/G	5180-00-610-8177	
9	F, H, D	TRANSCIVER RT-718/FR C- 93	5820-00-082-4080	
10	F, H, D	POWER SUPPLY PP-4151/FRC-93	5820-00-034-4239	
11	F, H, D	CONTROL, RADIO SET C-6118/FRC-93	5820-00-082-4082	

TM 11-5820-554-12

SECTION XXXVIII. REMARKS

REFERENCE CODE	REMARK
A	Continuity checks.
B	Repair shorts, opens. Replace running spare parts.

**SECTION XXXIX. MAINTENANCE ALLOCATION CHART
FOR
NOISE BLANKER F-1139/GRC-159**

(1) GROUP NUMBER	(2) COMPONENT ASSEMBLY	(3) MAINTENANCE FUNCTION	(4) MAINTENANCE CATEGORY					(5) TOOLS AND EQPT.	(6) REMARKS	
			C	O	F	H	D			
00	NOISE BLANKER, F-1139/ORC-159, COLLINS MODEL 136B-2, P/N 522-1661-00	Inspect Test Test Service Adjust Align Install Replace Repair Overhaul		0.2 0.3 0.2 1.0 1.0 1.5 1.5	1.0 1.0 2.5			3.0	2, 5, 6 1 thru 11 6 1 thru 11 1 thru 11 2, 5, 6 2, 5, 6 1 thru 11 1 thru 11	A
	NOTE Direct Support (F) level maintenance operations for fixed plant equipment located OCONUS, will be performed by off-site (Area Maintenance and Supply Facility (AMSF) personnel.									

TM 11-5820-554-12
SECTION XL. TOOL AND TEST EQUIPMENT REQUIREMENTS
FOR
NOISE BLANKER F-1139/GRC-159

TOOL OR TEST EQUIPMENT REF CODE	MAINTENANCE CATEGORY	NOMENCLATURE	NATIONAL/NATO STOCK NUMBER	TOOL NUMBER
1	F, H, D	GENERATOR, SIGNAL AN/GRM-50C	6625-00-003-3238	
2	O, F, H, D	MULTIMETER AN/USM-223	6625-00-999-7465	
3	F, H, D	MULTIMETER ME-26(*)/U.	6625-00-913-9781	
4	F, H, D	POWER SUPPLY PP-4151/FRC-93	5820-00-034-4239	
5	O, F, H, D	TEST SET, ELECTRON TUBE TV-7D/U	6625-00-820-0064	
6	O, F, H, D	TOOL KIT, ELECTRONIC EQUIPMENT TK-101/G	5180-00-064-5178	
7	F, H, D	TOOL KIT, ELECTRONIC EQUIPMENT TK-100/C	5180-00-605-0079	
8	F, H, D	TRANSCEIVER RT-718/FRC-93	5820-00-082-4080	
9	F, H, D	COUNTER, ELECTRONIC, DIGITAL READOUT AN/USM-207A	6625-00-044-3228	
10	F, H, D	DUMMY LOAD, ELECTRICAL DA-75/U	6625-00-177-1639	
11	F, H, D	TOOL KIT, ELECTRONIC EQUIPMENT TK-105/G	5180-00-610-8177	

SECTION XLI. REMARKS

REFERENCE CODE	REMARK
A	Continuity checks, and equipment operations.

**SECTION XLII. MAINTENANCE ALLOCATION CHART
FOR
CRYSTAL UNIT SET, QUARTZ CK-31/FRC-93**

(1) GROUP NUMBER	(2) COMPONENT ASSEMBLY	(3) MAINTENANCE FUNCTION	(4) MAINTENANCE CATEGORY					(5) TOOLS AND EQPT.	(6) REMARKS
			C	O	F	H	D		
00	<p>CRYSTAL UNIT SET, QUARTZ CK-31/FRC-93, COLLINS CP-1, P/N 597-0404-00</p> <p align="center">NOTES</p> <p>Test crystals in equipment operation, and repair by replacement Or individual items.</p> <p>No tools and/or test equipment are required</p>	<p>Inspect Test Replace Repair</p>		<p>0.2 0.5 0.2 0.5</p>					

TM 11-5820-554-12

**SECTION XLIII. MAINTENANCE ALLOCATION CHART
FOR
ANTENNA, TRANSPORTABLE COLLINS 637T-2**

(1) GROUP NUMBER	(2) COMPONENT ASSEMBLY	(3) MAINTENANCE FUNCTION	(4) MAINTENANCE CATEGORY					(5) TOOLS AND EQPT.	(6) REMARKS
			C	O	F	H	D		
00	ANTENNA, TRANSPORTABLE COLLINS 637T-2, P/N 772-5477-002	Inspect Test Service Replace		0.1 0.1 0.1 0.5					
	NOTE No tools and/or test equipment are required								

TM 11-5820-554-12

INDEX

	Paragraph	Page		Paragraph	Page
Adjustment, Q-Multiplier/notch filter (Waters 340A).....	5-3	5-1	Antenna, transportable (Collins 637T-2):		
Amplifier, Radio Frequency AM-3979/FRC 93.....	11-1	11-1	Operation.....	13-7	13-4
Antenna, transportable (Collins 637T-2).....	13-1	13-1	Operating principles.....	13-9	13-4
Block diagram, Receiver-Transmitter RT 718/FRC-93.....	3-14	3-15	Maintenance.....	13-12	13-4
Case, electrical equipment:			Controls, Radio Set C-6118/FRC-93 and C-7515/FRC-93:		
CY-6197/GRC-159.....	14-4	14-1	Operator's maintenance instructions.....	10-10	10-9
Collins CC-3.....	14-5	14-2	Organizational maintenance instructions.....	10-12	10-7
Circuit functioning:			Power supply, 12 volt d.c. input:		
Filter, Radio Interference F-1139/GRC 159(V).....	6-6	6-2	Operator's maintenance instructions.....	7-26	7-11
Receiver-Transmitter RT-718/FRC-93.....	3-14	3-15	Organizational maintenance instructions.....	7-28	7-11
Cleaning.....	3-24	3-17	Q-multiplier/notch filter (Waters 340-A):		
Configurations, Radio Set AN/FRC-93:			Operator's maintenance instructions.....	5-6	5-2
Fixed station 100-watt, 115-volt, 50- to 60-Hz.....	2-7	2-2	Organizational maintenance instructions.....	5-8	5-2
Fixed station 1-Kw, 115/230-volt a.c.....	2-8	2-2	Regulator, Voltage CN-1146/FRC-93:		
Mobile 100-watt, 24-volt d.c.....	2-5	2-2	Principles of operation.....	8-7	8-5
Mobile 100-watt 28-volt d.c.....	2-6	2-6	Operator's maintenance instructions.....	8-16	8-6
Portable 100-watt 14-volt d.c.....	2-2	2-1	Organizational maintenance instructions.....	8-18	8-6
Portable 100-watt, 110/220-volt a.c.....	2-3	2-1	Regulator, Voltage CN-1214/G:		
Portable 1,000-watt 110/220-volt a.c.....	2-4	2-1	Operator's maintenance instructions.....	9-10	9-4
Controls, radio sets:			Organizational maintenance instructions.....	9-12	9-4
C-6118/FRC-93.....	10-1	10-1	Impedance matching (Antenna, transportable Collins 637T-2).....	13-10	13-4
C-7515/FRC-93.....	10-1	10-1	Indexes of publications.....	1-2	1-1
Controls and indicators:			Initial checks:		
Regulator, Voltage CN-1214/G.....	9-7	9-2	Power supply, 12-volt d.c. input (Collins MP-1).....	7-23	7-9
Description:			Receiver-Transmitter RT-718/FRC-93.....	3-8	3-6
Antenna, transportable (Collins 637T-2).....	13-1	13-1	Installation:		
Controls, Radio Set C- 6118/FRC-93 and C-7515/FRC-93.....	10-1	10-1	Amplifier, Radio Frequency AM-3979/FR-93.....	11-4	11-1
Coupler, Antenna CU-2004/U.....	12-1	12-1		11-9	11-2
Crystal Unit Set, Quartz CK-31/FRC-93.....	4-1	4-1	Antenna, transportable(Collins 637T-2)	13-4	13-2
Power supplies:			Controls, Radio Set, C-6118/FRC-93 and C-7615/FRC-93:	13-6	13-4
PP-3990/FRC-93.....	7-1	7-1	(Collins 312B-4).....	10-4	10-3
PP-4151/FR-93.....	7-5	7-7	(Collins 312B-5).....	10-5	10-3
PP-4765/GRC-159(V).....	7-13	7-7	Coupler, Antenna, CU-2004/U.....	12-3	12-4
12-volt d.c. input (Collins MP-1).....	7-19	7-8	Power supplies:		
Q-multiplier/notch filter (Waters 340A).....	5-1	5-1	PP-3990/FRC-93.....	7-4	7-2
Regulators, voltage:			PP-4151/FRC-93.....	7-10	7-6
CN-1146/FRC-93.....	8-1	8-1	PP-4765/GRC-159(V).....	7-16	7-8
CN-1214/G.....	9-1	9-1	12-volt d.c. input (Collins MP-1).....	7-22	7-9
Disassembly procedure (antenna, transportable, Collins 637T-2).....	13-13	13-4	Receiver-Transmitter RT-718/FRC-93	3-6, 3-7, 3-2	3-6
Erecting procedure (antenna, transportable, Collins 637T-2).....	13-5	13-2	Regulators, voltage:		
Forms and records.....	1-3	1-1	CN-1146/FRC-93.....	8-5, 8-6, 8-4	
Gain (antenna, transportable, Collins 637T-2).....	13-11	13-4	CN-1214/G.....	9-5, 9-6, 9-7, 9-2	
General:					
Amplifier RF AM-3997/FRC-93:					
Introduction.....	11-1	11-1			
Operator's maintenance.....	11-12	11-7			
Organizational maintenance.....	11-14	11-7			

TM 11-5820-554-12

	Paragraph	Page
Items comprising an operable equipment:		
Amplifier, RF AM-3979/FRC-93	11-3	11-1
Antenna, transportable (Collins 637T-2)	13-3	13-2
Controls, Radio Set C-6118/FRC-93 and C-7515/FRC-93	10-3	10-2
Coupler, Antenna CU-2004/U	12-2	12-1
Filter, Radio Interference, F-1139/GRC-159(V)	6-4	6-1
Power Supplies:		
PP-3990/FRC-93	7-3	7-2
PP-4151/FRC-93	7-9	7-5
PP-4765/GRC-159(V)	7-15	7-8
12-volt d.c. input (Collins MP-1)	7-21	7-9
Receiver-Transmitter RT-718/FRC-93	3-5	3-2
Regulator, voltage:		
CN-1146/FRC-93	8-4	8-1
CN-1214/G	9-4	9-1
Q-Multiplier/notch filter (Waters 340-A)	5-2	5-1
Items required for maintenance	3-20	3-17
Limitations (Filter, Radio Interference, F-1139/GRC-159 (V))		
Load, Dummy DA-75/U	6-7	6-2
Lowering procedure (antenna, transportable Collins 637T-2)	14-6	14-2
Lowering procedure (antenna, transportable Collins 637T-2)	13-6	13-4
Maintenance (antenna, transportable Collins 637T-2)		
	13-12, 13-13, 13-14	13-4, 13-16
Microphone, Headset, (Collins MM-2)	14-2	14-1
Microphone, Dynamic M-127/FRC-93 (Collins MM-1)	14-1	14-1
Mounting and cabling (RT-718/FRC-93)	3-7	3-2
Operating frequency selection (antenna, transportable Collins 637T-2)	13-8	13-4
Operating procedures (Regulator, Voltage CN-1214/G)	9-8	9-4
Operation:		
Controls, Radio Set C 6118/FRC-93 and C-7515/FRC-93:		
Directional coupler and wattmeter	10-7	10-3
Station control switches	10-8	10-7
Vfo in Collins 312B-5	10-9	10-7
Filter, Radio Interference F-1139/GRC-159(V)	6-5	6-1
In amateur bands (AM-3979/FRC-93)	11-10	11-5
Outside amateur bands:		
Amplifier, RF, AM-3979/FRC-93	11-11	11-6
Receiver-Transmitter RT-718/FRC-93	3-13	3-11
Power supplies:		
PP-3990/FRC-93	7-5	7-4
PP-4151/FRC-93	7-11	7-6
PP-4765/GRC-159(V)	7-17	7-8
12-volt d.c. input (Collins MP-1)	7-24	7-10
Receiver-Transmitter RT-718/FRC-93	3-9	3-6
	3-13	3-7
Operator's daily preventive maintenance checks and services chart for:		
Amplifier, RF AM-3979/FRC-93	11-13	11-7
Controls, Radio Set C-6118/FRC-93 and C-7515/FR C-93	10-11	10-9
Coupler, Antenna, CU-2004/C	12-6	12-3
Power supplies	7-27	7-11
Q-Multiplier/notch filter (Waters 340-A)	5-7	5-2
Receiver-Transmitter RT-718/FRC-93	3-23	3-17
Regulators, voltage:		
CN-1146/FRC-93	8-17	8-4
CN-1214/G	9-11	9-4
Organizational quarterly preventive maintenance checks and services chart		

for:

Amplifier, RF AM-3979/FRC-93	11-15	11-7
Controls, Radio Sets C-6118/FRC-93 and C-7515/FRC-93	10-13	10-10
Coupler, Antenna CU-2004/U	12-8	12-3
Crystal Unit Set, Quartz CK-31/FRC-93	4-4	4-1
Filter, Radio Interference F-1139/GRC-159(V)	6-9	6-2
Power supplies	7-29	7-12
Q-multiplier/notch filter (Waters 340-A)	5-9	5-2
Receiver-Transmitter RT-718/FRC-93	3-28	3-18
Regulators, voltage:		
CN-1146/FRC-93	8-19	8-6
CN-1214/G	9-16	9-5
Oscillators (RT-718/FRC-93)	3-17	3-16
Preventive maintenance	3-21	3-17
Preventive maintenance checks and services periods	3-22	3-17
Q-multiplier/notch filter effectiveness	5-4	5-2
Quarterly preventive maintenance	3-27	3-18
Reassembly procedure (antenna, transportable, Collins 637T-2)	13-14	13-6
Receiver:		
Circuits	3-16	3-15
Tuning	3-11	3-7
Requirements for operation (RT-718/FRC-93)	3-3	3-1
Scope	1-1	1-1
Scope of:		
Operator's maintenance	3-19	3-16
Organizational maintenance	3-25	3-18
Selecting Collins KWM-2/2A operating frequency	3-10	3-6
Site selection (antenna, transportable, Collins 637T-2)	13-4	13-2
Starting procedure (RT-718/FRC-93)	3-9	3-6
Stopping procedure (Regulator, Voltage, CN-1214/G)	9-9	9-4
Tabulated data:		
Amplifier, RF AM-3979/FRC-93	11-2	11-1
Antenna, transportable (Collins 637T-2)	13-2	13-2
Controls, Radio Set C-6118/FRC-93 and C-7515/FRC-93	10-2	10-2
Filter, Radio Interference F-1139/GRC-159(V)	6-2	6-1
Power supplies:		
PP-3990/FR C- 93	7-2	7-1
PP-4151/FRC-93	7-2	7-5
PP-4765/GRC-159(V)	7-14	7-7
12-volt input (Collins MP-1)	7-20	7-8
Receiver-Transmitter RT-718/FRC-93	3-4	3-1
Regulators, voltage:		
CN-1146/FRC-93 8-3	8-3	8-1
CN-1214/G 8-3	9-3	9-1

TM 11-5820-554-12

	Paragraph Page			Paragraph Page	
Tools, materials, and test equipment required.....	3-26	3-18	Tuning procedure (Coupler, Antenna CU 2004/U)	12-4	12-2
Touchup painting.....	3-29	3-18	Use (Crystal Unit Set, Quartz C K-31/F R C 93)	4-2	4-1
Transmitter:			Vox and antivoix circuits	3-18	3-16
Circuits	3-15	3-15			
Tuning	3-12	3-7			

By Order of the Secretary of the Army:

FRED C. WEYAND
General, United States Army
Chief of Staff

Official:

PAUL T. SMITH

Major General, United States Army
The Adjutant General

Distribution:

To be distributed in accordance with DA Form 12-50, (qty rqr block No. 186) Operator Maintenance requirements for AN/FRC-93.

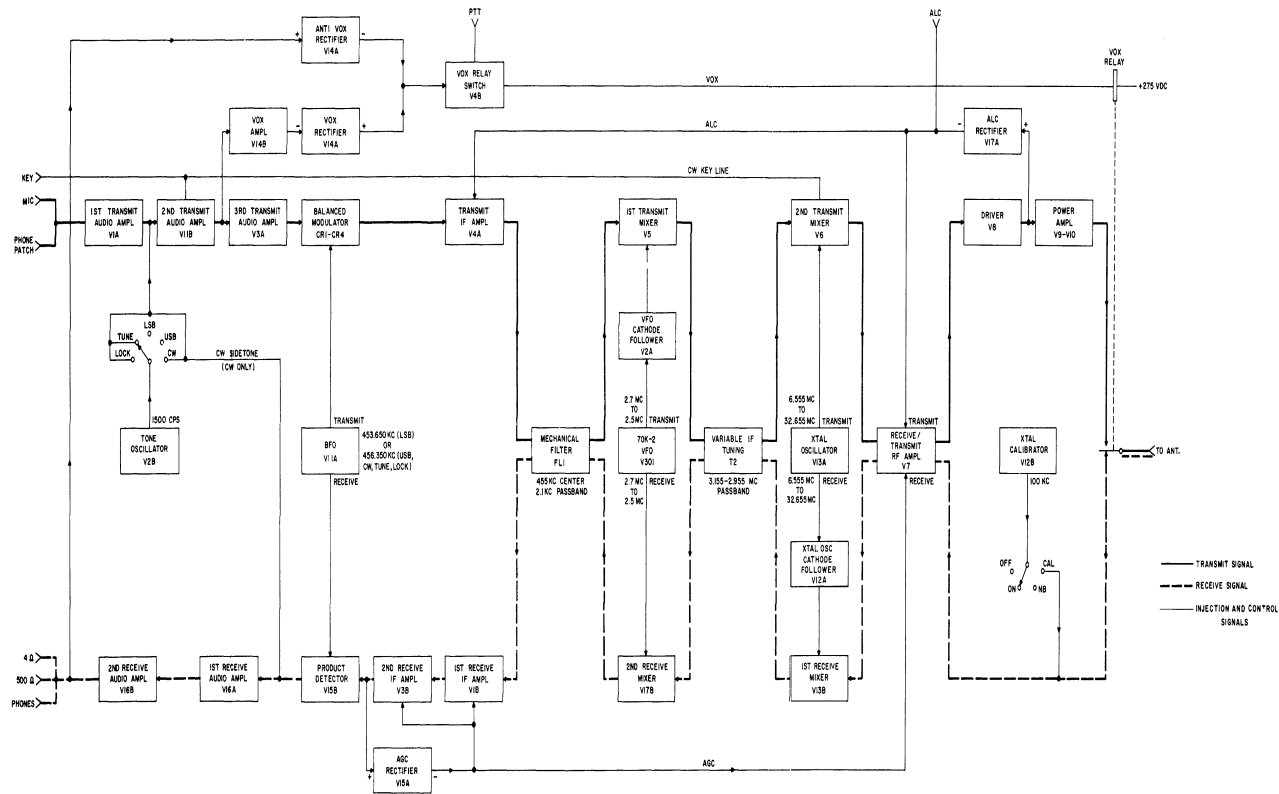
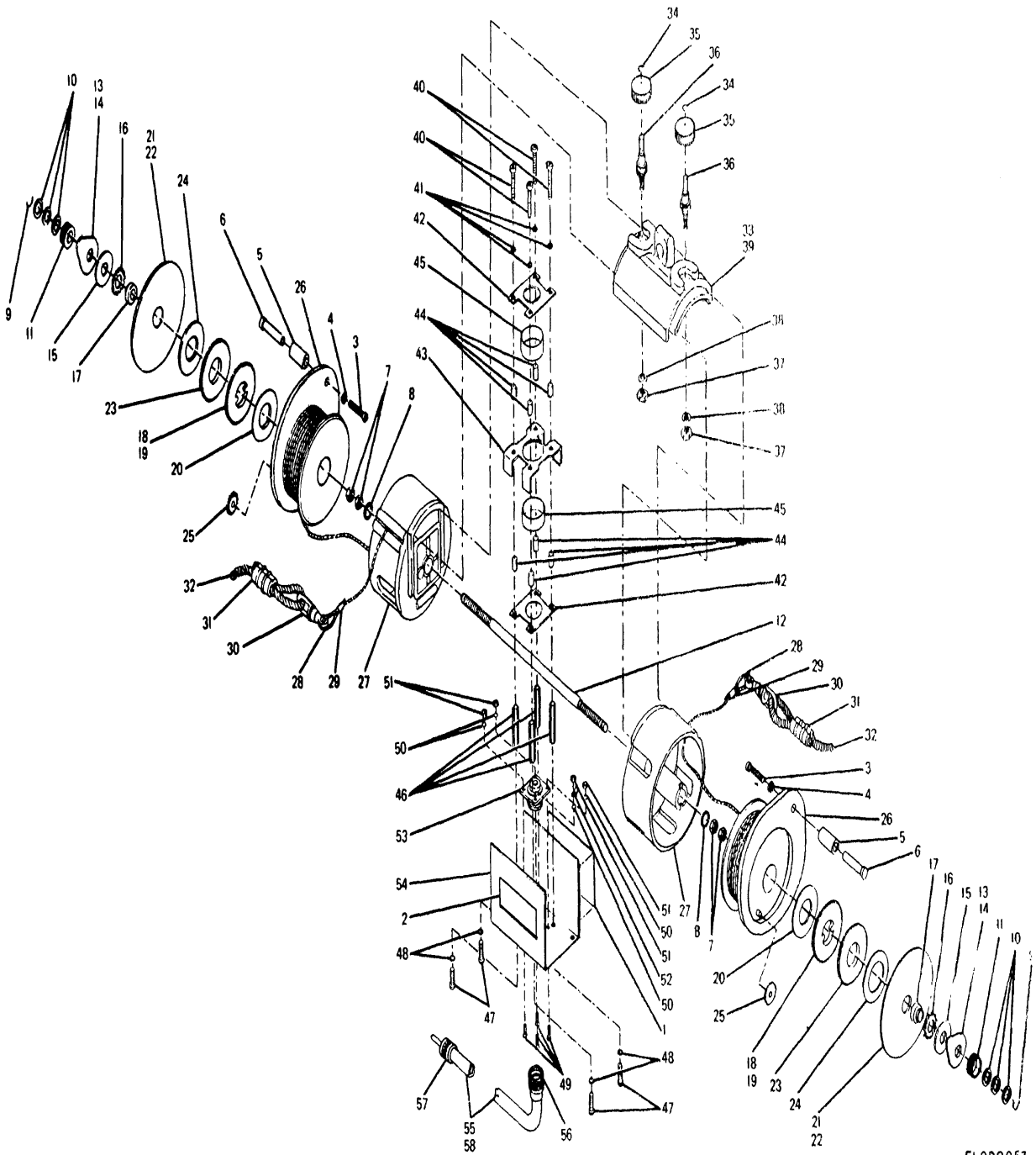

Figure FO-1. Receiver-Transmitter RT-718/FRC-93, block diagram

1 Plate, identification
2 Plate, instruction
3 Screw, machine
4 Washer, flat
5 Sleeve
6 Handle
7 Ring, retaining
8 Lockwasher
9 Ring, retaining
10 Washer, flat
11 Knob, clamp indicator
12 Rod assembly
13 Dial indicator assembly
14 Dial indicator
15 Washer, adhesive
16 Lockwasher
17 Insert
18 Spur gear
19 Spur gear
20 Washer, tape
21 Dial assembly
22 Dial
23 Spur gear
24 Washer
25 Gear, pinion
26 Reel, antenna
27 Housing, molded
28 Rope, bronze wire
29 Sleeve, wire rope
30 Swivel, eye
31 Sleeve, wire rope
32 Rope, polypropylene
33 Balun
34 Ring, retaining
35 Knob, clamp
36 Stud, terminal
37 Nut, hexagonal
38 Lockwasher
39 Block, terminal
40 Screw, machine
41 Washer, spring
42 Spacer, balun
43 Spacer, balun
44 Sleeve, spacing
45 Core, ferrite
46 Post, hexagonal
47 Screw, machine
48 Washer, spring
49 Screw, machine
50 Lockwasher
51 Nut, hexagonal
52 Terminal, lug
53 Connector, electrical, single-contact
54 Cover, balun



EL000053

Figure FO-2. Antenna, transportable, Collins G37T-2, exploded view

RECOMMENDED CHANGES TO EQUIPMENT TECHNICAL PUBLICATIONS



THEN...JOT DOWN THE DOPE ABOUT IT ON THIS FORM. CAREFULLY TEAR IT OUT, FOLD IT AND DROP IT IN THE MAIL.

SOMETHING WRONG WITH PUBLICATION

FROM: (PRINT YOUR UNIT'S COMPLETE ADDRESS)

DATE SENT

PUBLICATION NUMBER

PUBLICATION DATE

PUBLICATION TITLE

BE EXACT PIN-POINT WHERE IT IS

PAGE NO.	PARA-GRAPH	FIGURE NO.	TABLE NO.

IN THIS SPACE, TELL WHAT IS WRONG AND WHAT SHOULD BE DONE ABOUT IT.

TEAR ALONG PERFORATED LINE

PRINTED NAME, GRADE OR TITLE AND TELEPHONE NUMBER

SIGN HERE

DA FORM 1 JUL 79 2028-2

PREVIOUS EDITIONS ARE OBSOLETE.

P.S.--IF YOUR OUTFIT WANTS TO KNOW ABOUT YOUR RECOMMENDATION MAKE A CARBON COPY OF THIS AND GIVE IT TO YOUR HEADQUARTERS.

PIN: 015523-000