

★

HANDBOOK OF
OPERATING INSTRUCTIONS

for

RADIO SETS

SCR-522-A and SCR-542-A

This handbook replaces AN 08-40SCR522-2
dated 9 May 1944.

(For Official Use Only)

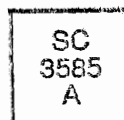

★
Approved 30 DECEMBER 1944

Published under joint authority of the United States War and Navy
Departments and the Air Council of the United Kingdom.

SECURITY NOTICE

FOR U. S. PERSONNEL: This document contains information affecting the national defense of the United States within the meaning of the Espionage Act, 50 U.S.C., 31 and 32, as amended. Its transmission or the revelation of its contents in any manner to an unauthorized person is prohibited by law. (AR 380-5) (ARTS 75½ & 76, U.S.N. REGS-1920.)

The information contained in restricted documents and the essential characteristics of restricted materiel will not be communicated to the public or to the press, but may be given to any

person known to be in the service of the United States and to persons of undoubted loyalty and discretion who are cooperating in Government work.

FOR BRITISH PERSONNEL: For Official Use Only—Not to be communicated to anyone outside His Majesty's Service. Not to be published. The information given in this document is not to be communicated, either directly or indirectly, to the press or to any person not holding an official position in His Majesty's Service.

LIST OF REVISED PAGES ISSUED

NOTE: A heavy black vertical line, to the left of the text on revised pages, indicates the extent of the revision. This line is omitted where more than 50 percent of the page is revised.

ADDITIONAL COPIES OF THIS PUBLICATION MAY BE OBTAINED AS FOLLOWS:

AAF ACTIVITIES.—In accordance with T.O. No. 00.25-3, base Air Inspectors, Technical, will submit requisitions (AAF Form 104B) to the Commanding General, Fairfield Air Technical Service Command, Patterson Field, Fairfield, Ohio. Attention: Publications Distribution Branch.

NAVY ACTIVITIES.—Submit requests to the Chief, Bureau of Aeronautics, Navy Department, Washington, D. C.

BRITISH ACTIVITIES.—Submit requirements on Form 294A, in duplicate, to the Air Publications and Forms Store, New College, Leadhall Lane, Harrogate, Yorkshire, England.

TABLE OF CONTENTS

<i>Section</i>	<i>Page</i>	<i>Section</i>	<i>Page</i>
Safety Notice	ii	8. Transmitter Tuning (Using Test Equipment IE-36)	2-16
Destruction of Abandoned Materiel in the Combat Zone	iii	<i>a.</i> Equipment Required	2-16
Unsatisfactory Report	iii	<i>b.</i> Initial Procedure	2-16
I. GENERAL DESCRIPTION	1-1—1-4	<i>c.</i> Tuning Channel "A"	2-16
1. General	1-1	<i>d.</i> Adjusting Remaining Channels	2-17
2. Power Supply	1-1	<i>e.</i> Current Checks	2-17
<i>a.</i> Radio Set SCR-522-A	1-1	<i>f.</i> Final Modulation Check	2-18
<i>b.</i> Radio Set SCR-542-A	1-1	<i>g.</i> Tuning One Channel Only	2-18
3. Temperature Limitations	1-1	<i>b.</i> Transmitter "GAIN" Control Adjustment	2-18
4. Transmission-Reception Range	1-2	<i>i.</i> Significance of Meter Readings	2-18
5. Principal Components	1-2	9. Testing Radio Receiver BC-624-A, BC-624-AM or BC-624-C (Using Test Equipment IE-36)	2-19
<i>a.</i> Equipment Supplied	1-2	10. Receiver Tuning (Using Test Equipment IE-19())	2-19
<i>b.</i> Equipment Required But Not Supplied (Installation)	1-3	<i>a.</i> Equipment Required	2-19
<i>c.</i> Equipment Required But Not Supplied (Testing and Aligning)	1-4	<i>b.</i> Initial Procedure	2-19
II. INSTALLATION AND ADJUSTMENT	2-0—2-24	<i>c.</i> Crystal Selection	2-19
1. Preliminary Tests	2-0	<i>d.</i> Adjustment of Signal Generator I-130-A	2-20
<i>a.</i> Using Test Equipment IE-19-()	2-0	<i>e.</i> Tuning Channel "A"	2-20
<i>b.</i> Using Test Equipment IE-36	2-1	<i>f.</i> Tuning Remaining Channels	2-21
2. Installation	2-5	<i>g.</i> Tuning Single Channel Out of Adjustment	2-22
<i>a.</i> Transmitter-Receiver Assembly	2-5	<i>b.</i> Tuning Checks	2-22
<i>b.</i> Dynamotor Unit PE-94-()	2-5	<i>i.</i> Receiver "AUDIO" Control Adjustment	2-22
<i>c.</i> Jack Box BC-629-B or BC-631-B	2-5	<i>j.</i> Receiver "RELAY" or "SQUELCH" Control Adjustment	2-22
<i>d.</i> Radio Control Box BC-602-B or BC-602-D	2-6	11. Receiver Tuning (Using Test Equipment IE-36 and a Suitable Headset)	2-23
<i>e.</i> Antenna Mast AN-104-A or AN-104-B	2-6	<i>a.</i> Tuning Channel "A"	2-23
<i>f.</i> Microphones	2-6	<i>b.</i> Tuning Remaining Channels	2-23
3. Making of Cables	2-8	<i>c.</i> Tuning One Channel Only	2-24
<i>a.</i> Disassembly of Plugs	2-8	<i>d.</i> Receiver "AUDIO" Control Adjustment	2-24
<i>b.</i> Wiring and Reassembly of Plugs	2-8	<i>e.</i> Receiver "RELAY" or "SQUELCH" Control Adjustment	2-24
4. Cable Connections	2-9	12. Testing Remote (Press-to-Talk) Operation (Using Test Equipment IE-36)	2-24
5. Circuit Protection Devices	2-9	III. OPERATION	3-1—3-2
6. Testing Radio Transmitter BC-625-A or BC-625-AM (Using Test Equipment IE-36)	2-9	1. General	3-1
7. Transmitter Tuning (Using Test Equipment IE-19-())	2-13	2. Starting and Stopping the Equipment	3-1
<i>a.</i> Equipment Required	2-13	3. Normal Operation	3-1
<i>b.</i> Initial Procedure	2-13	<i>a.</i> Transmission	3-1
<i>c.</i> Tuning of First Channel	2-14	<i>b.</i> Reception	3-2
<i>d.</i> Tuning Remaining Channels	2-14	<i>c.</i> Press-to-Transmit (Press-to-Talk) Operation	3-2
<i>e.</i> Adjusting Antenna Coupling Control	2-14		
<i>f.</i> Final Tuning	2-15		
<i>g.</i> Tuning Checks	2-15		
<i>h.</i> Tuning Single Channel Out of Adjustment	2-15		
<i>i.</i> Transmitter "GAIN" Control Adjustment	2-15		

TABLE OF CONTENTS (Continued)

<i>Section</i>	<i>Page</i>	<i>Section</i>	<i>Page</i>
4. Defense Against Radio Jamming	3-2	2. Failure of Transmitter and Receiver to Operate	4-0
<i>a.</i> General	3-2		
<i>b.</i> Procedure	3-2	V. SUPPLEMENTARY DATA	5-1—5-5
IV. EMERGENCY ADJUSTMENT OR REPAIR	4-0	1. Modification of Receiver and Transmitter. 5-1	
1. Replacement of Pilot Lamps in Radio Control Box BC-602-B and BC-602-D	4-0	<i>a.</i> Radio Transmitter BC-625-AM	5-1
		<i>b.</i> Radio Receiver BC-624-C	5-1
		2. Types of Radio Jamming	5-1
		3. Tables	5-1

**LIST OF TABLES**

<i>Table</i>	<i>Page</i>	<i>Table</i>	<i>Page</i>
5-1. Tube Complement	5-1	5-4. VHF Airborne Command Set, Crystal vs Carrier Frequencies	5-3
5-2. Pilot Lamp Complement	5-2		
5-3. Modifications of Major Assemblies of Radio Set SCR-522-A	5-2		

**LIST OF ILLUSTRATIONS**

<i>Figure</i>	<i>Page</i>	<i>Figure</i>	<i>Page</i>
1-1. Radio Set SCR-522-A—Principal Components iv		2-6. Radio Control Box BC-602-B— Front and Side Views	2-7
1-2. Radio Set SCR-522-A in Case CS-80-A (left) and Dynamotor Unit PE-94-A or PE-94-B (right)	1-1	2-7. Radio Control Box BC-602-B— Outline Dimensions	2-7
1-3. Radio Set SCR-522-A in Case CS-80-C with Mounting FT-488 (left) and Dynamotor Unit PE-94-C with Mounting FT-498 (right) 1-2		2-8. Antenna Mast AN-104-A— Outline Dimensions	2-8
2-1. Radio Set SCR-522-A—Transmitter- Receiver Assembly in Rack FT-244-A	2-2	2-9. Microphone Adapter M-299— Outline Dimensions	2-9
2-2. Transmitter-Receiver Assembly in Case CS-80-C—Installation Dimensions	2-3	2-10. Cable Assembly with Plug PL-P173	2-10
2-3. Dynamotor Unit PE-94-C— Installation Dimensions	2-4	2-11. Cable Assembly with Plug PL-Q173	2-10
2-4. Jack Boxes BC-629-B (left) and BC-631-B (right)	2-5	2-12. Radio Set SCR-522-A— Typical Wiring Diagram	2-11
2-5. Jack Box BC-629-B or BC-631-B— Outline Dimensions	2-6	2-13. Jack Box BC-631-B— Typical Wiring Diagram	2-12
		2-14. Test Equipment IE-36	2-16
		2-15. Control Unit BC-1303 (Part of Test Equipment IE-36)	2-17

SAFETY NOTICE

This equipment may employ high voltages which are dangerous and may be fatal if contacted by operating personnel. Exercise extreme caution when working with the equipment.

Destruction of Abandoned Materiel in the Combat Zone

In case it should become necessary to prevent the capture of this equipment and when ordered to do so, DESTROY IT SO THAT NO PART OF IT CAN BE SALVAGED, RECOGNIZED, OR USED BY THE ENEMY. BURN ALL PAPERS AND BOOKS.

Means:—

1. Explosives, when provided.
2. Hammers, axes, sledges, machetes, or whatever heavy object is readily available.
3. Burning by means of incendiaries such as gasoline, oil, paper, or wood.
4. Grenades and shots from available arms.
5. Burying all debris or disposing of it in streams or other bodies of water, where possible and when time permits.

Procedure:—

1. Obliterate all identifying marks. Destroy nameplates and circuit labels.
2. Demolish all panels, castings, switch- and instrument-boards.
3. Destroy all controls, switches, relays, connections, and meters.
4. Rip out all wiring and cut interconnections of electrical equipment. Smash gas, oil, and water-cooling systems in gas-engine generators, etc.
5. Smash every electrical or mechanical part, whether rotating, moving, or fixed.
6. Break up all operating instruments such as keys, phones, microphones, etc.
7. Destroy all classes of carrying cases, straps, containers, etc.
8. Bury or scatter all debris.

DESTROY EVERYTHING!



Unsatisfactory Report

For U. S. Army Air Force Personnel:

In the event of malfunctioning, unsatisfactory design, or unsatisfactory installation of any of the component units of this equipment, or if the material contained in this book is considered inadequate or erroneous, an Unsatisfactory Report, AAF Form No. 54, or a report in similar form, shall be submitted in accordance with the provisions of Army Air Force Regulation No. 15-54, listing:

1. Station and organization.
2. Nameplate data (type number or complete nomenclature if nameplate is not attached to the equipment).
3. Date and nature of failure.
4. Radio model and serial number.
5. Remedy used or proposed to prevent recurrence.
6. Handbook errors or inadequacies, if applicable.

For U. S. Navy Personnel:

Report of failure of any part of this equipment during its guaranteed life shall be made on Form N. Aer. 4112, "Report of Unsatisfactory or Defective Material," or a report in similar form, and forwarded in accordance with the latest instructions of the Bureau of Aeronautics. In addition to other distribution required, one copy shall be furnished to the inspector of Naval Materiel (location to be specified) and the Bureau of Ships. Such reports of failure shall include:

1. Reporting activity.
2. Nameplate data.
3. Date placed in service.
4. Part which failed.
5. Nature and cause of failure.
6. Replacement needed (yes—no).
7. Remedy used or proposed to prevent recurrence.

For British Personnel:

Form 1022 procedure shall be used when reporting failure of radio equipment.

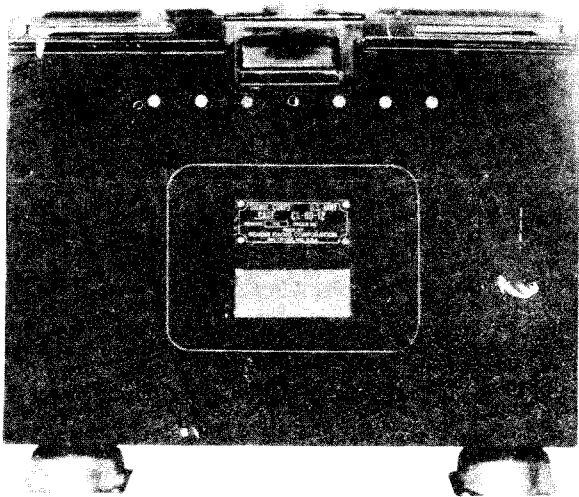

RADIO TRANSMITTER BC-625-A,
RADIO RECEIVER BC-624-A AND
RACK FT-244-A IN CASE CS-80-A

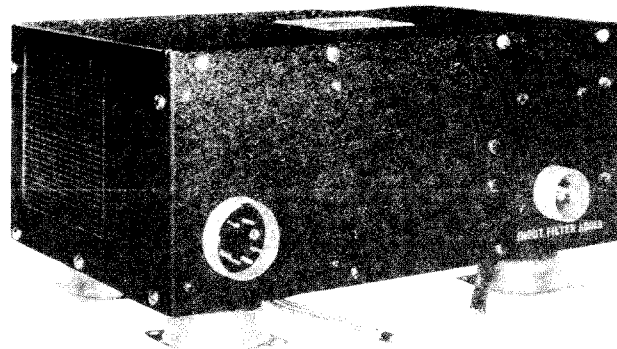

DYNAMOTOR UNIT PE-94-A
OR
DYNAMOTOR UNIT PE-94-B

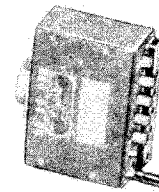

RADIO CONTROL
BOX BC-602-B

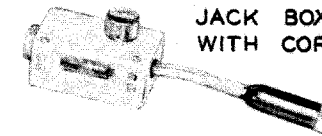

JACK BOX BC-629-B
WITH CORD CD-495

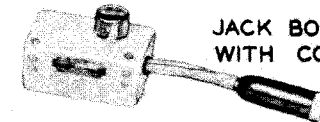

JACK BOX BC-631-B
WITH CORD CD-495

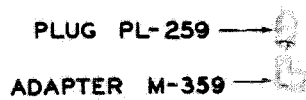

PLUG PL-259

ADAPTER M-359

ANTENNA MAST AN-104-A



PLUG
PL-Q173

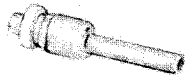

PLUG
PL-P173



PLUG
PL-167



PLUG
PL-172



PLUG
PL-171



PLUGS
PL-169



PLUG
PL-170

Figure 1-1. Radio Set SCR-522-A—Principal Components

SECTION I

GENERAL DESCRIPTION

SPECIAL NOTICE

Radio Set SCR-522-A differs from Radio Set SCR-542-A only in the primary power supply voltage and the dynamotor unit used. This handbook applies to both radio sets except as otherwise noted in the text.

1. GENERAL.

a. Radio Set SCR-522-A or SCR-542-A (see fig. 1-1) is airborne equipment providing two-way radio telephone communication between aircraft in flight and between aircraft and ground stations.

b. Operation may take place on any one of four crystal-controlled channels lying within the frequency range of 100 to 156 megacycles. Only remote control is provided. Continuous tone transmission on any channel on which the equipment is operating is provided by the action of Contactor Unit BC-608-A for Radio Transmitter BC-625-AM (a later model of the transmitter) while continuous tone transmission on channel D only is provided by the action of the contactor unit for Radio Transmitter BC-625-A

2. POWER SUPPLY.

a. RADIO SET SCR-522-A.—The power required to operate Radio Set SCR-522-A is 11.5 amperes total input current at 28 volts for transmission, and 11.1 amperes total input current at 28 volts for reception. The radio

set uses Dynamotor Unit PE-94-()* (see figs. 1-2 and 1-3) which is supplied with power from the 28-volt battery of the airplane.

Note

The equipment will operate satisfactorily from an ungrounded power source, but a grounded negative power source is preferable.

b. RADIO SET SCR-542-A.—The power required to operate Radio Set SCR-542-A is 23 amperes total input current at 14 volts for transmission, and 22.2 amperes total input current at 14 volts for reception. This radio set uses Dynamotor Unit PE-98-A which is supplied with power from the 14-volt battery of the airplane.

3. TEMPERATURE LIMITATIONS.

The equipment is designed to operate satisfactorily in the temperature range from -58°F (-50°C) to $+122^{\circ}\text{F}$ ($+50^{\circ}\text{C}$). A small percentage of all equipments manufactured have been subjected, as a type test, to a humidity of 90 to 100 percent with the temperature held at $+122^{\circ}\text{F}$ ($+50^{\circ}\text{C}$) for a period of 24 hours and then checked for satisfactory operation.

* Any reference to Dynamotor Unit PE-94-() applies to Dynamotor Units PE-94-A, PE-94-B, and PE-94-C.

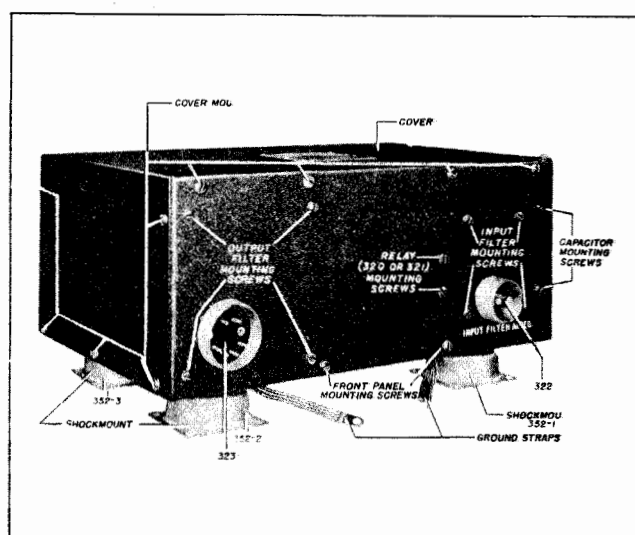
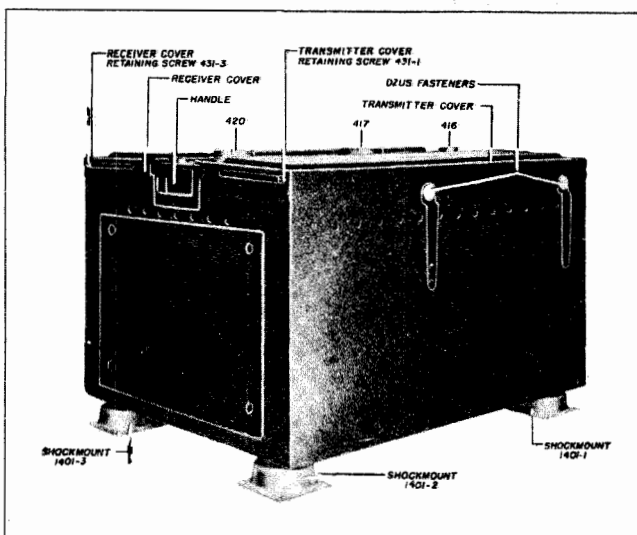

Figure 1-2. Radio Set SCR-522-A in Case CS-80-A (left) and Dynamotor Unit PE-94-A or PE-94-B (right)

Section I

Paragraphs 4-5

AN 16-40SCR522-2

4. TRANSMISSION-RECEPTION RANGE.

The following table lists the approximate range of transmission and reception during communication between an aircraft and a ground station over level country.

Altitude of Airplane Above Terrain (feet)	Approximate Range (miles)
1,000	30
3,000	70
5,000	80
10,000	120
15,000	150
20,000	180

5. PRINCIPAL COMPONENTS.

a. EQUIPMENT SUPPLIED.—Principal components supplied with the radio set are listed in the table below.

Quantity	U. S. Signal Corps Description	British Air Ministry Description	British Ref. No.	Over-all Dimensions (inches)	Weight (pounds)
1	Radio Transmitter BC-625-A or BC-625-AM*	1 Radio Transmitter Unit, Type T.5017	110D/146		
1	Radio Receiver BC-624-A or BC-624-AM, or BC-624-C†	1 Radio Receiver Unit, Type R.5019	110D/147		
1	Rack FT-244-A	1 Rack, Type 5009	110D/148		
1	Case CS-80-A or CS-80-C	Case, Type TR.5043	110D/145	16 ⁵ / ₃₂ x 12 ¹¹ / ₁₆ x 10 ¹¹ / ₁₆	49
1	Mounting FT-488 (used with Case CS-80-C)			19 ⁷ / ₆₄ x 12 ¹¹ / ₁₆ x 1/2	.25
8	Crystal Unit DC-11-A, or DC-16 or DC-26 or CR-1A/AR	Crystal Unit	110XN/	11 ³ / ₁₆ x 1 ⁹ / ₁₆ x 1 ¹ / ₁₆ 1 ¹ / ₈ x 1 ³ / ₁₆ x 7 ¹ / ₁₆	0.13 Each .024 Each
1	Dynamotor Unit PE-94-A or PE-94-B or PE-94-C	Dynamotor Unit, Type 5016	110K/248	12 ²⁵ / ₃₂ x 8 ²⁷ / ₃₂ x 6 ¹⁵ / ₆₄	37
1	Dynamotor Unit PE-98-A‡	Dynamotor Unit, Type 5015	110K/247	12 ²⁵ / ₃₂ x 8 ²⁷ / ₃₂ x 6 ¹⁵ / ₆₄	37
1	Mounting FT-498 (used with Dynamotor Unit PE-94-C)			8 ¹ / ₄ x 12 ²⁵ / ₃₂ x 1/2	.25

*Radio Transmitter BC-625-A and BC-625-AM are electrically and physically interchangeable.

†Radio Receiver BC-624-A, BC-624-AM and BC-624-C are electrically and physically interchangeable.

‡This dynamotor unit used with Radio Set SCR-542-A.

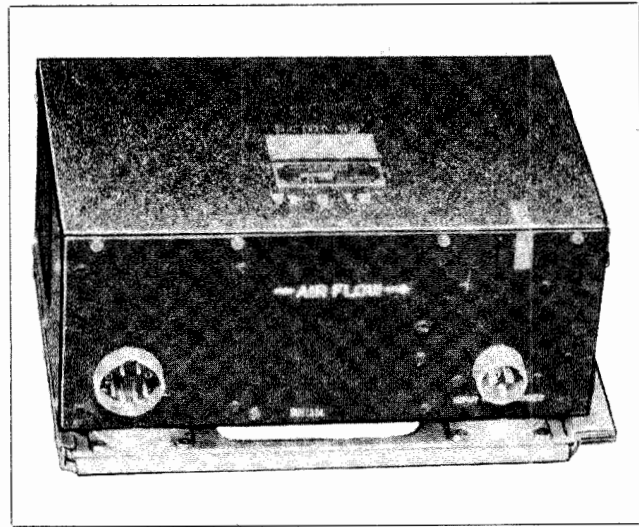
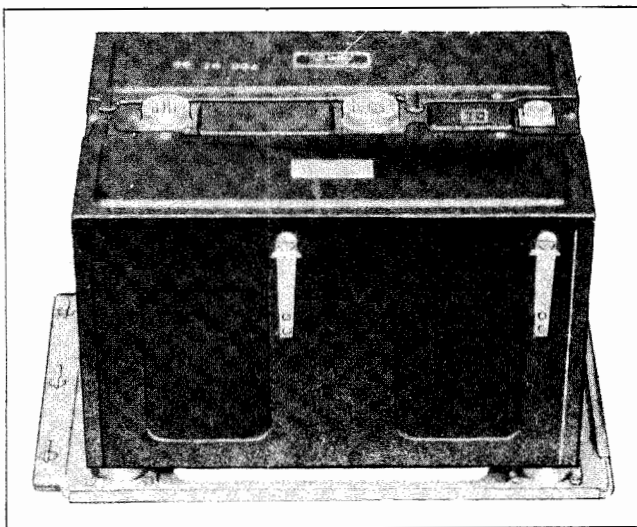

Figure 1-3. Radio Set SCR-522-A in Case CS-80-C With Mounting FT-488 (left) and Dynamotor Unit PE-94-C With Mounting FT-498 (right)

AN 16-40SCR522-2

Quantity	U. S. Signal Corps Description	British Air Ministry Description	British Ref. No.	Over-all Dimensions (inches)	Weight (pounds)
1	Jack Box BC-629-B or BC-631-B	Jack Box	110A/241	$4\frac{27}{64} \times 2\frac{29}{64} \times 1\frac{61}{64}$ $4\frac{1}{16} \times 2\frac{29}{64} \times 1\frac{61}{64}$	0.60
1	Package of Maintenance Parts				
1	Antenna Mast AN-104-A or AN-104-B§				
1	Plug PL-P167	Socket, Type W149	10H/403	2 $\frac{5}{8}$ L., 1 $\frac{19}{64}$ Dia.	0.25
	or				
	Plug PL-Q167 (may be used on Jack Box BC-629-B; not used on Jack Box BC-631-B)	Socket, Type W150	10H/404	2 $\frac{1}{64}$ H., 2 $\frac{49}{64}$ L., 1 $\frac{19}{64}$ Dia.	0.27
	or				
	Plug PL-167				
1	Plug PL-P169	Socket, Type W161	10H/415	2 $\frac{1}{4}$ L., 1 $\frac{21}{32}$ Dia.	0.29
	or				
	Plug PL-Q169	Socket, Type W162	10H/416	2 $\frac{1}{64}$ H., 2 $\frac{15}{16}$ L., 1 $\frac{21}{32}$ Dia. 1 $\frac{21}{32}$ L., 1 $\frac{5}{16}$	0.31
	or				
	Plug PL-169				
1	Plug PL-P170	Socket, Type W163	10H/417	2 $\frac{1}{4}$ L., 1 $\frac{59}{64}$ Dia.	0.34
	or				
	Plug PL-Q170	Socket, Type W164	10H/418	2 $\frac{5}{32}$ H., 3 $\frac{13}{64}$ L., 1 $\frac{59}{64}$ Dia. 1 $\frac{59}{64}$ L., 1 $\frac{23}{64}$	0.56
	or				
	Plug PL-170				
1	Plug PL-P171	Socket, Type W159	10H/413	2 $\frac{1}{4}$ L., 1 $\frac{21}{32}$ Dia.	0.30
	or				
	Plug PL-Q171	Socket, Type W160	10H/414	2 $\frac{1}{64}$ H., 2 $\frac{15}{16}$ L., 1 $\frac{21}{32}$ Dia.	0.29
	or				
	Plug PL-171			1 $\frac{21}{32}$ L., 1 $\frac{31}{64}$	
1	Plug PL-P172	Socket	110H/459	2 $\frac{35}{64}$ L., 1 $\frac{19}{64}$ Dia.	0.28
	or				
	Plug PL-Q172	Socket, Type W165	10H/419	2 $\frac{33}{64}$ H., 2 $\frac{19}{32}$ L., 1 $\frac{19}{64}$ Dia.	0.29
	or				
	Plug PL-172			1 $\frac{19}{64}$ L.; 1 $\frac{39}{64}$	
1	Plug PL-P173	Plug, Type 156	110H/584	2 $\frac{29}{64}$ L., 1 $\frac{1}{4}$ Dia.	0.21
	or				
	Plug PL-Q173	Plug, Type 150	110H/507	2 $\frac{51}{64}$ H., 2 $\frac{7}{8}$ L., 1 $\frac{1}{4}$ Dia.	0.35
1	Plug PL-259**	Plug, Type 1	110H/1257	4 $\frac{7}{64}$ L., 1 $\frac{17}{32}$	
1	Radio Control Box BC-602-B or BC-602-D†	Controller, Type 5003	110J/71	7 $\frac{7}{8}$ x 5 $\frac{9}{16}$ x 2 $\frac{1}{2}$	2.41

§Antenna Mast AN-104-B is an improved version of the antenna mast as far as electrical band coverage is concerned and is mechanically interchangeable with Antenna Mast AN-104-A.

**Adapter M-359 shall be used when a right angle approach to the antenna base is desired.

†Field modification of Radio Control Box BC-602-B in which the "T-R-REM." switch has been disconnected and the switch has been removed completely have resulted in Radio Control Box BC-602-D.

b. EQUIPMENT REQUIRED BUT NOT SUPPLIED (INSTALLATION). — The following table includes equipment required for satisfactory operation but not included with the radio set.

U. S. INSTALLATIONS

Quantity	Name of Unit	Required Characteristics
1	Headset HS-33 or	600 ohms impedance
1	Headset HS-38	600 ohms impedance
1†	Microphone T-17, T-17-B, T-17-C, T-17-D or	
1†	Microphone T-30-()*	
	or	
1	Microphone T-34-A or	

Quantity	Name of Unit	Required Characteristics
1	Microphone T-44-()*	
	or	
1	Microphone ANB-M-C1	

BRITISH INSTALLATIONS

Quantity	Name of Unit	Required Characteristics
1‡	Cord CD-495	
1	Headset, Type 32 (Ref. No. 10A/13466) or	150 ohms impedance

*Refers to any issue of a specific series.

†Requires Microphone Adapter M-299.

‡Required by British electromagnetic microphones and British headsets.

BRITISH INSTALLATIONS (Continued)

Quantity	Name of Unit	Required Characteristics
1	Headset, Type B (Ref. No. 110A/ 8542)	24,000 ohms impedance
1	Microphone, Type 21 (Ref. No. 10A/ 11994) or	250 ohms impedance, electromagnetic
1	Microphone, Type 26 (Ref. No. 10A/ 12571)	250 ohms impedance, electromagnetic
1§	Microphone Adapter M-299	
1	Source of d-c power	12 or 28 volts

§Used only when high impedance carbon microphones are used.

c. EQUIPMENT REQUIRED BUT NOT SUPPLIED (TESTING AND ALIGNING).—The following table lists equipment required for testing and aligning but not supplied with the radio set.

Quantity	Name of Unit
1	Test Equipment IE-36
1	Signal Generator I-96-A
1	Test Equipment IE-19-()* (includes the following):
1	Field Strength Meter I-95-()*
1	Test Set I-139-A
1	Signal Generator I-130-A
1	Battery Box BX-33-A

*Refers to any issue of a specific series.

SECTION II INSTALLATION AND ADJUSTMENT

Note

The radio set is normally shipped from the factory with all vacuum tubes installed.

1. PRELIMINARY TESTS.

Before installing the transmitter-receiver assembly in an aircraft, check the operation of the transmitter-receiver with either Test Equipment IE-19-()* or IE-36. (See figs. 2-14 and 2-15.)

a. USING TEST EQUIPMENT IE-19-().

(1) Place the transmitter-receiver assembly on the test bench.

(2) Loosen the Dzus fasteners on the rack covers, raise the covers, and slide them away from the center.

(3) Connect Dynamotor Unit PE-94-()* to the 12-contact socket on Rack FT-244-A. Connect Radio Control Box BC-602-B or BC-602-D (fig. 2-7) and Jack Box BC-629-B (fig. 2-4) to the 18-contact socket on the rack.

(4) Connect the dynamotor unit to a 28-volt d-c source of supply or 14-volt for Dynamotor Unit PE-98-()*.

(5) Depress channel "A" push button on the radio control box. The top channel slides on both transmitter and receiver frequency shifter assemblies will be actuated.

(6) If the shifter mechanism does not operate when channel "A" is selected, press channel release button 426 in Rack FT-244-A (fig. 2-1) because the motor may be stopped on an open contact position.

*Any issue letter is applicable.

(7) Depress channel push buttons "B", "C", and "D" and note the action of the shifter mechanism.

(8) Connect Antenna Mast AN-104-A or AN-104-B to Socket SO-153 on the rack by means of a suitably prepared length of coaxial cable.

(9) Insert the proper crystals for the pre-tuned channels in the transmitter. (Refer to par. 7b(2), this section.) Depress channel "A" push button.

(10) Set up Field Strength Meter I-95-()* and extend the antenna on the meter to the desired length, depending on the strength of the signal. Turn the "ON-OFF" switch on the meter to "ON." Adjust the "ZERO ADJ." control so that the "RELATIVE FIELD STRENGTH" meter on the field strength meter reads zero. Set the "TUNING" dial to the frequency of the transmitter and adjust the dial for a maximum reading on the "RELATIVE FIELD STRENGTH" meter.

(11) Plug Microphone T-34-A or T-44-()* into Jack K-49 through the jack box. Place the "T-R-REM." switch in the "T" position and speak into the microphone. There should be a slight increase in the reading of the indicating meter on Field Strength Meter I-95-()*, indicating modulation.

(12) Do not disturb the transmitter "GAIN" control if it is locked with glyptal or with a locking nut. If the control is not locked, advance, if necessary, to secure modulation.

Note

The "GAIN" control has been replaced by a fixed resistance network in later models of

AN 16-40SCR522-2

Radio Transmitter BC-625-AM, and no adjustment is necessary. (Refer to sec. V, par. 1a.)

(13) Leave the "T-R-REM." switch in the "T" position (or actuate the microphone press-to-talk button if Radio Control Box BC-602-D is in use) and repeat step (11) above on channels "B," "C," and "D." If proper operation of any channel is not obtained or if the channel frequencies have to be changed, retune in accordance with the instructions in paragraph 7 or 8 of this section.

(14) Place crystals of the proper operating frequency in the channels to be used in the receiver. (Refer to par. 10c, this sec.)

(15) Depress channel "A" push button.

(16) Set the "T-R-REM." switch on the radio control box to "R". The equipment is normally in the receive position if Radio Control Box BC-602-D is in use. Connect a headset to Jack K-49 through the jack box.

(17) Set the receiver "AUDIO" control (236) and "RELAY" or "SQUELCH" (237) to their clockwise positions.

Note

The "RELAY" control has been replaced by the "SQUELCH" control in Radio Receiver BC-624-C. (Refer to sec. V, par. 1b.)

(18) With no signal applied, turn the "RELAY" or "SQUELCH" control counterclockwise until the signal is sharply cut off. Make the final setting of the "RELAY" or "SQUELCH" and "AUDIO" controls in the airplane. (Refer to pars. 10i and 10j, this sec.)

(19) Return the "RELAY" or "SQUELCH" control to the maximum clockwise position. Apply a small signal of proper frequency from Signal Generator I-130-A through Cord CD-477 to Socket SO-153 on Rack FT-244-A. The signal should be heard in the headset. Repeat this step on channels "B," "C," and "D."

(20) If proper operation of any channel is not obtained or if the frequencies are to be changed, retune in accordance with the instructions in paragraphs 10 and 11 of this section.

b. USING TEST EQUIPMENT IE-36.

(See figure 2-14.)

(1) Place the transmitter-receiver assembly on the test bench.

(2) Loosen the Dzus fasteners on Rack FT-244-A; raise the covers slightly, and slide them away from the center.

(3) Connect Dynamotor Unit PE-94() to the 12-contact socket on the rack. Plug Control Unit BC-1303, part of Test Equipment IE-36, into the 18-contact socket on the rack.

(4) Connect the dynamotor unit to a 28-volt d-c source of supply or to a 14-volt source for Dynamotor Unit PE-98().

(5) Turn the "OFF ABCD" switch on the control unit to "A." The top channel slides on both transmitter and receiver frequency shifter assemblies will be actuated.

(6) If the shifter mechanism does not operate when channel "A" is selected, press channel release button 426 in the rack because the motor may be stopped on an open contact position.

(7) Make a similar check for channels "B," "C," and "D."

(8) Plug Phantom Antenna A-29 into Socket SO-153 on the rack.

(9) Insert the proper crystals in the pre-tuned channels in the transmitter. (Refer to par. 7b(2), this sec.)

(10) Turn the "OFF ABCD" switch on the control unit to position "A."

(11) Throw the toggle switch on the control unit to "T" (or actuate the microphone press-to-talk button). The lamp in the phantom antenna should light.

(12) Plug Microphone T-34-A or T-44-() into Cord CD-1169. Plug Cord CD-1169 into the control unit. If Microphone T-17 is used, plug it directly into the control unit. Speak into the microphone. The lamp in the phantom antenna should increase in brilliance indicating modulation.

(13) Do not disturb the transmitter "GAIN" control if it is locked with glyptal or with a locking nut. If it is not locked, advance if necessary to secure modulation.

Note

The "GAIN" control has been replaced by a fixed resistance network in later models of Radio Transmitter BC-625-AM and no adjustment is necessary.

(14) Repeat step (12) on channels "B," "C," and "D." If proper operation on any channel is not obtained, or if the channel frequencies have to be changed, retune in accordance with the instructions in paragraphs 7 or 8 of this section.

(15) Place crystals of the proper operating frequency in the channels to be used in the receiver. (Refer to par. 10c, this sec.)

(16) Insert the probe end of Cord CD-1170 in the "ANT" jack on the control unit and clip the alligator clip on the other end of the cord to the center pin of socket 416 on the rack.

(17) Place the "OFF ABCD" switch of the control unit in position "A."

(18) Throw the "T-R-REM." switch on the control unit to the "R" position. If Radio Control Box BC-602-D is in use, the equipment is normally in the receive position. Plug a suitable headset into the jack marked "TEL" on the control unit.

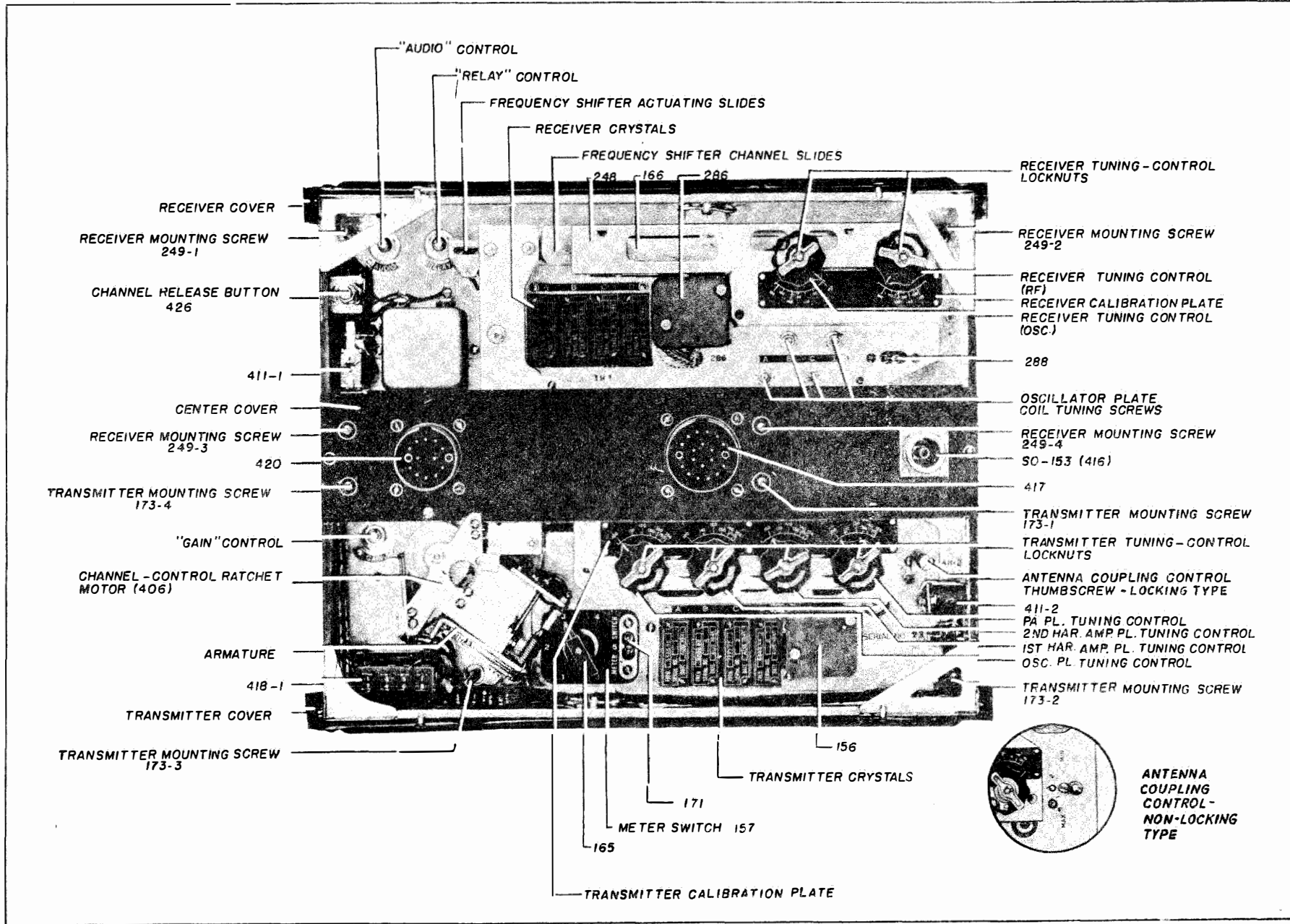
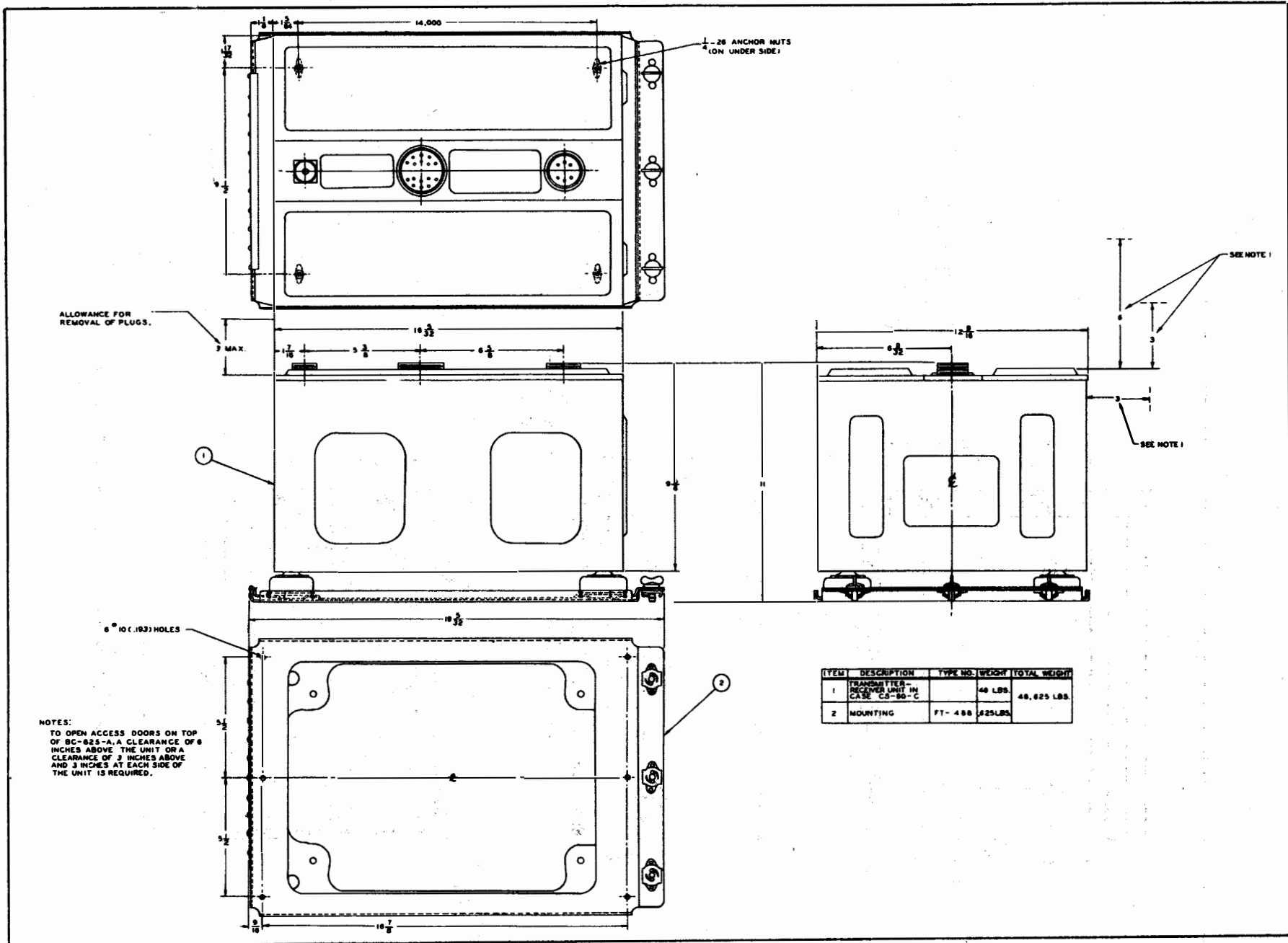

Figure 2-1. Radio Set SCR-522-A—Transmitter-Receiver Assembly in Rack FT 244-A



AN 16-40SCR522-2

Section II

Figure 2-2. Transmitter-Receiver Assembly in Case CS-80-C—Installation Dimensions

ITEM	DESCRIPTION	TYPE NO.	WEIGHT	TOTAL WEIGHT
1	TRANSMITTER-RECEIVER UNIT IN CASE CS-80-C		48 LBS.	48.625 LBS.
2	MOUNTING	FT-488	625 LBS.	

NOTES:
 TO OPEN ACCESS DOORS ON TOP OF BC-825-A A CLEARANCE OF 6 INCHES ABOVE THE UNIT OR A CLEARANCE OF 3 INCHES ABOVE AND 3 INCHES AT EACH SIDE OF THE UNIT IS REQUIRED.

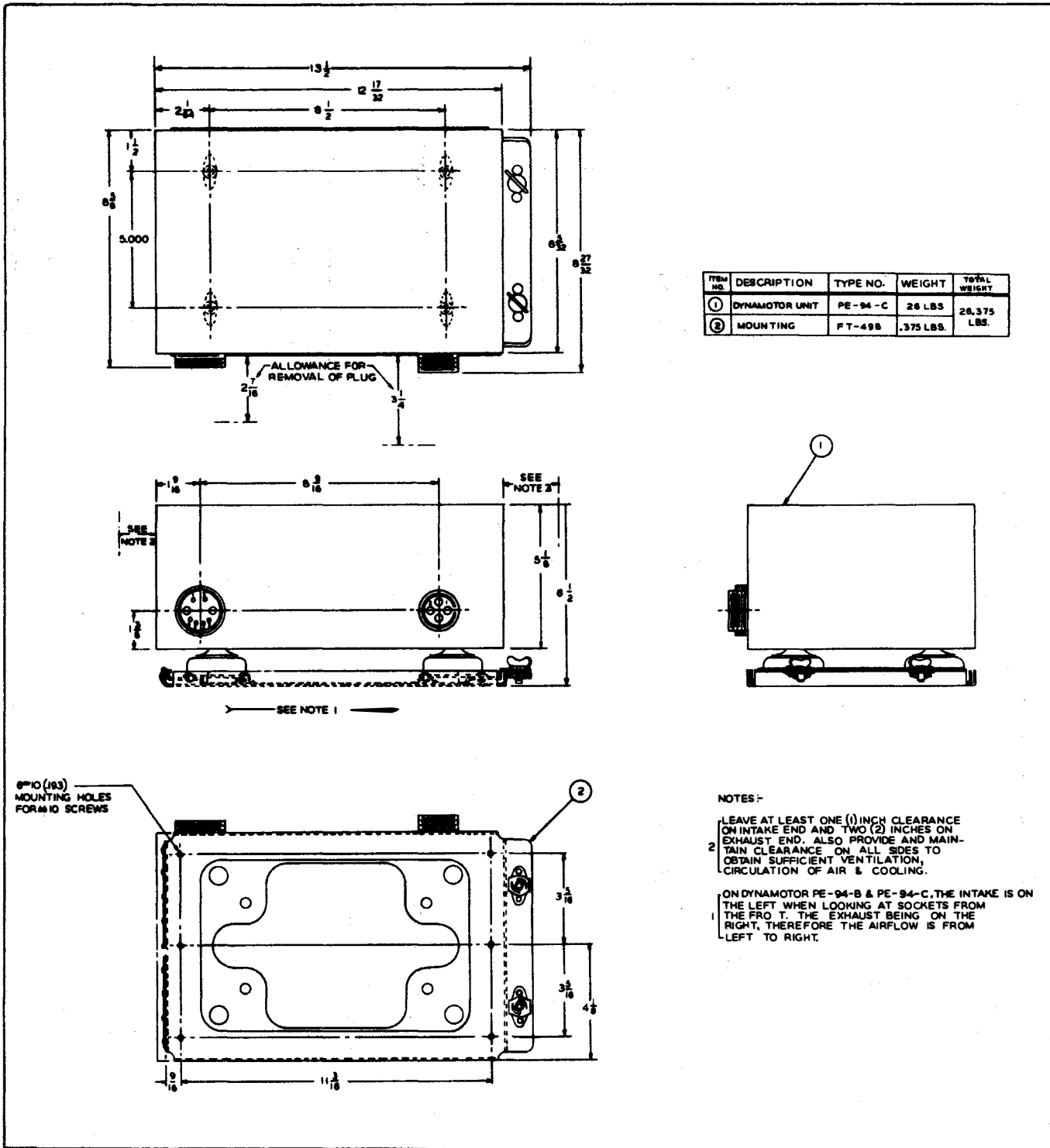

Figure 2-3. Dynamotor Unit PE-94-C—Installation Dimensions

AN 16-40SCR522-2

(19) Set the receiver "AUDIO" control (236) and "RELAY" or "SQUELCH" control (237) to their maximum clockwise position.

(20) With no signal applied, turn "RELAY" or "SQUELCH" control counterclockwise until the signal is sharply cut off. Make the final setting of the "RELAY" or "SQUELCH" and "AUDIO" controls in the airplane. (Refer to par. 11*d* and 11*e*, this sec.)

(21) Return the "RELAY" or "SQUELCH" control to the maximum clockwise position. Turn the "SIG. GEN." switch on Control Unit BC-1303 to the "ON" position. A tone should be heard in the headset. Repeat this step for channels "B," "C," and "D."

(22) If proper operation of any channel is not obtained or if the frequencies are to be changed, retune the equipment in accordance with the instructions given in paragraphs 10 and 11 of this section.

2. INSTALLATION.

Note

Install the radio set in accordance with specific installation data pertaining to the airplane in which the equipment is to be installed. Installation instructions for Radio Receivers BC-624-A, BC-624-AM and BC-624-C are the same, and the receivers are interchangeable. The same is true of Radio Transmitters BC-625-A and BC-625-AM.

a. TRANSMITTER-RECEIVER ASSEMBLY. — Allow sufficient clearance on all sides of the transmitter-receiver assembly for free action of the shock-mounts, rack and plug removal, and access to the tuning adjustment controls on the transmitter-receiver panel. (See fig. 2-2.)

Note

Attach each ground strap (the case has one and the dynamotor unit has two or four) to a shockmount mounting hole by means of a

mounting screw inserted in the lug in the free end of the ground strap.* This must be a good ground connection.

b. DYNAMOTOR UNIT PE-94-(). — Install the dynamotor unit so that there is at least a 2-inch clearance on the intake end and a 3-inch clearance on the exhaust end. (See fig. 2-3.)

CAUTION

Note that the direction of air flow through Dynamotor Units PE-94-B and PE-94-C is opposite the direction of air flow through Dynamotor Unit PE-94-A. The air flow through Dynamotor Unit PE-94-A is from the input socket toward the output socket.

c. JACK BOX BC-629-B or BC-631-B.—The jack box provides terminals for the microphone input and audio output circuits. To prepare the jack box for installation proceed as follows.

(1) Remove the three screws from the covers of the jack box and take off the cover. (See figs. 2-4 and 2-5.)

(2) Drill mounting holes in the bottom of the jack box. Do not damage the wires or the soldering lugs.

(3) Remove all metallic chips to insure against short circuits.

(4) If it is desired to move the socket to the opposite end of the jack box, proceed as follows:

(*a*) Remove the four screws from each end plate.

(*b*) Remove the end plate opposite the socket. Note the position of the grounding lug on the socket end plate.

(*c*) Transfer the complete socket-and-end plate assembly to the desired side. Do not neglect to replace the grounding lug.

*On Dynamotor Unit PE-94-C and PE-94-F the ground strap is already fastened to the shockmount mounting screw.

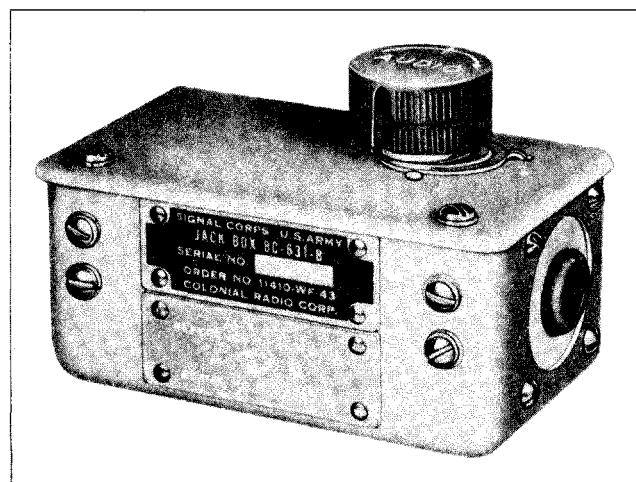
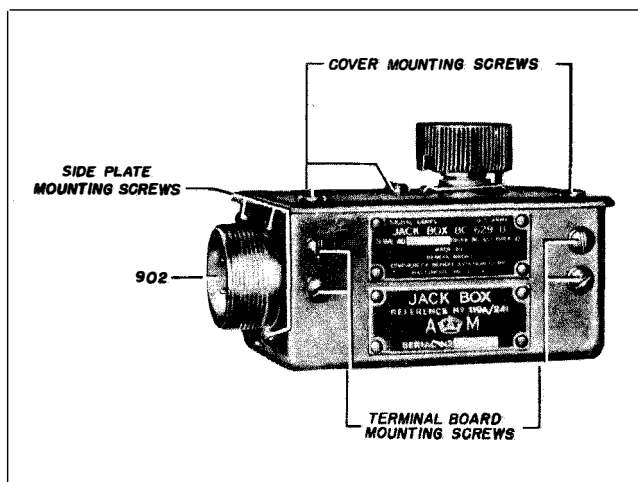

Figure 2-4. Jack Boxes BC-629-B (left) and BC-631-B (right)

Section II

Paragraph 2

AN 16-40SCR522-2

(d) Fasten the grommet end plate to the side on which the socket was formerly located.

(5) Mount the jack box so that the volume control is accessible to the operator.

d. RADIO CONTROL BOX BC-602-B or BC-602-D.—Prepare the radio control box for installation in the following manner:

(1) Loosen the four screws in the side plate containing the four countersunk mounting holes and remove the plate.

(2) Fasten a suitable mounting bracket to the side plate. (Use flathead screws and mount them flush with the inside surface of the plate to prevent possible short circuits in some portion of the control circuit wiring.)

(3) Replace the side plate.

(4) Mount the radio control box with the control panel accessible and visible to the pilot. (See figs. 2-6 and 2-7.)

Note

The side plates of Radio Control Box BC-602-B or BC-602-D are interchangeable.

e. ANTENNA MAST AN-104-A OR AN-104-B. (See figure 2-8.)

(1) Mount this antenna mast vertically on a part of the aircraft where there are no projections that might

interfere with the radiation pattern of the antenna to obtain a uniform circular pattern in a horizontal plane.

(2) Secure the antenna mast to the aircraft by means of a bracket mounted inside the skin of the airplane.

(3) Fasten one end of a copper ground strap, at least 1/2 inch wide and no more than 2 inches long, to the ground bus screw on the antenna. Fasten the other end to the skin of the airplane near the point where the bracket secures the antenna to the airplane.

Note

Leave a small amount of slack in the ground strap to allow for vibration.

(4) Connect one end of the antenna cable to Socket SO-239 on the base of the antenna mast and the other end to Socket SO-153 on Rack FT-244-A. (Refer to par. 3b(3), this sec., for instruction for making the antenna cable.)

f. MICROPHONES.

(1) ELECTROMAGNETIC TYPE.—Connect the electromagnetic type microphone directly to the jack box.

(2) CARBON TYPE.—Connect the carbon type microphone through Microphone Adapter M-299 (see figs. 2-9 and 2-12) to the jack box.

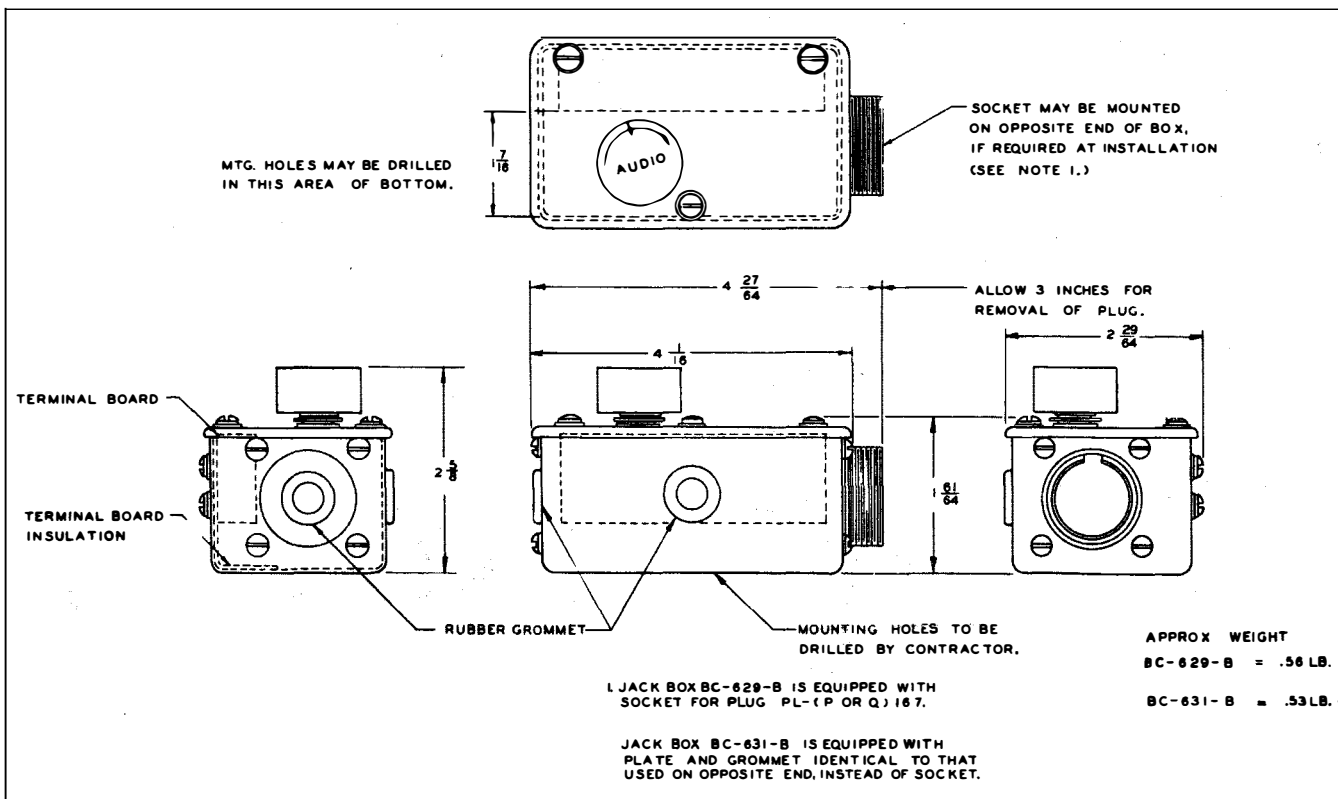

Figure 2-5. Jack Box BC-629-B or BC-631-B—Outline Dimensions

AN 16-40SCR522-2

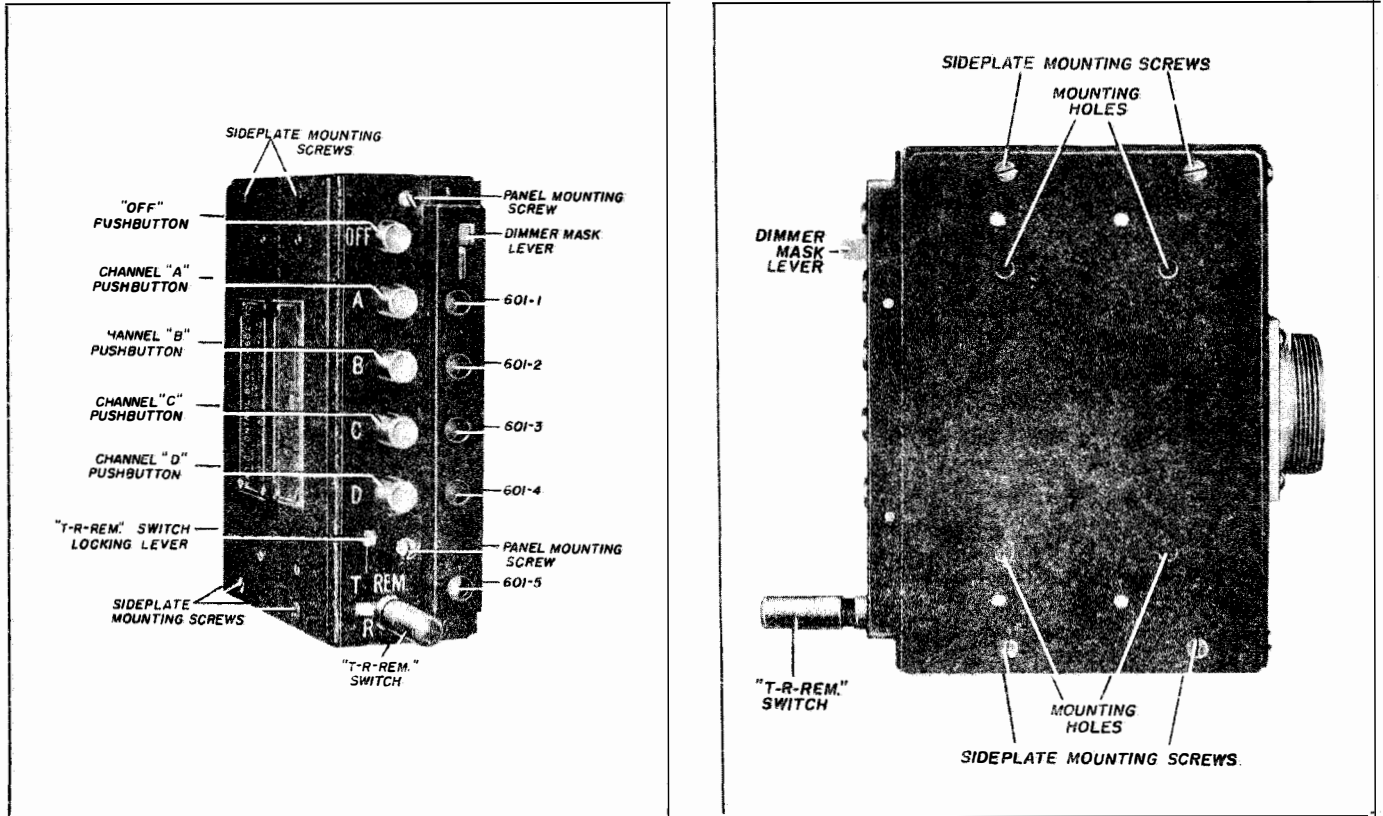

Figure 2-6. Radio Control Box BC-602-B—Front and Side Views

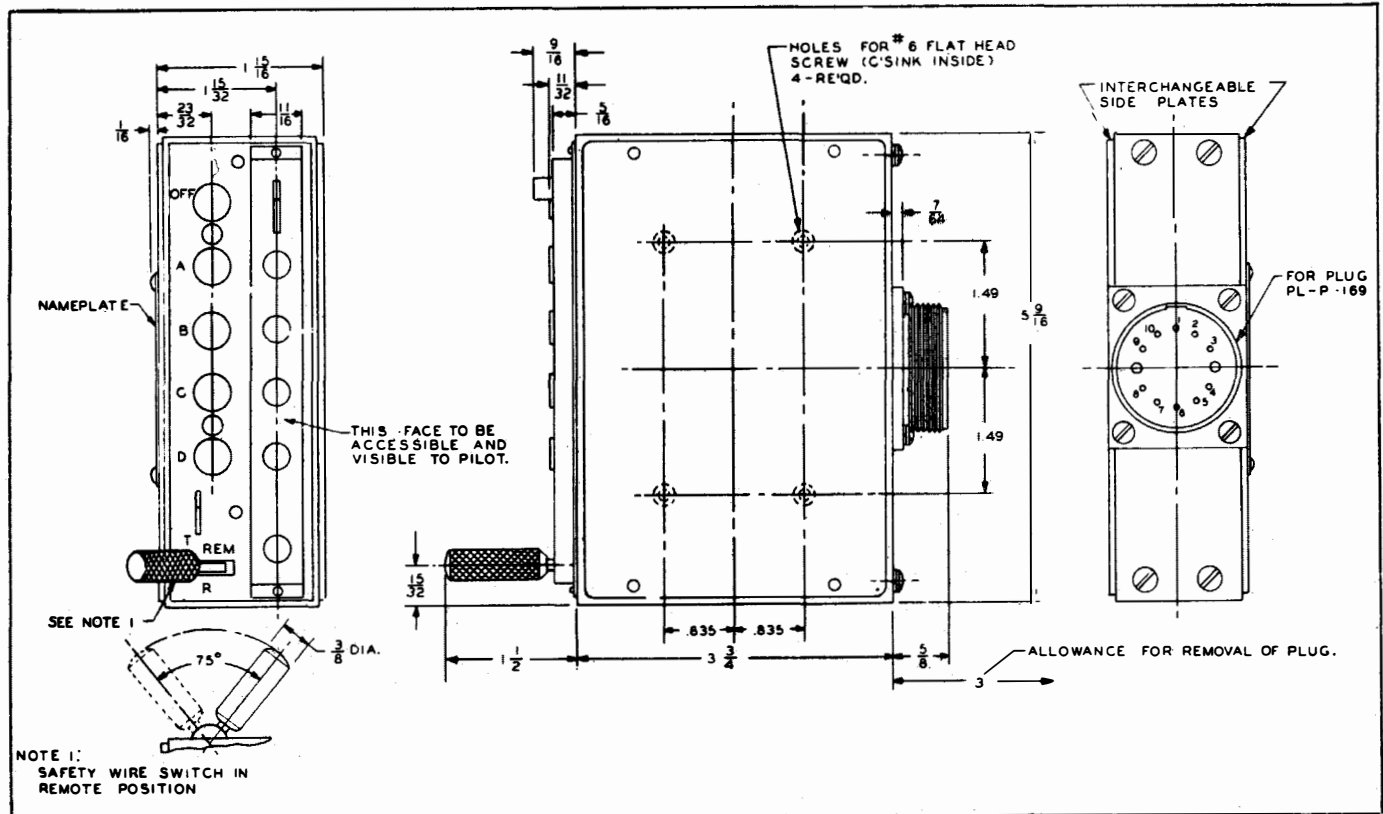

Figure 2-7. Radio Control Box BC-602-B—Outline Dimensions

Section II

Paragraph 3

AN 16-40SCR522-2

3. MAKING OF CABLES.

a. DISASSEMBLY OF PLUGS.

(1) PLUG PL-P172 OR PL-Q172.

(a) Insert Plug PL-P172 or PL-Q172 into the corresponding socket located on the dynamotor unit or hold the plug body (metal shell containing the insulated insert) with a pair of pliers.

(b) Turn the plug end ring counterclockwise, using a spanner wrench, if necessary. The ferrule, coupling nut, cable fitting, end ring, and locking ring will be loosened; remove the plug body.

(c) Carefully draw the plug body out of the socket. Remove the two screws from the plug-assembly insulation and remove the two large female contacts from the plug washers.

(2) PLUG PL-P173 OR PL-Q173.

(a) Remove the two screws from the clamp assembly of Plug PL-P173 or PL-Q173. (See figs. 2-10 and 2-11.)

(b) Remove the smaller section of the clamp.

(c) Turn the larger clamp section counterclockwise to disassemble the plug.

(3) BAKELITE WIRE GUIDE TYPE PLUGS.

(a) Insert the plug in a corresponding socket for support.

(b) With a wrench, loosen the locking ring. Remove the plug from the socket.

(c) Remove the locking ring and the bakelite wire guide.

(4) REMAINING PLUGS.

(a) Disassemble the remaining plugs for wiring by inserting them in their corresponding sockets or by holding the plug bodies with a pair of pliers and turning their rings counterclockwise until the ferrules, coupling nuts, cable fittings, end rings, and locking rings can be removed.

(b) Draw the plug bodies out of their sockets for wiring. Do not remove pins from bakelite insert.

b. WIRING AND REASSEMBLY OF PLUGS.

(1) PLUG PL-P172 OR PL-Q172.

(a) Cut the required length of #10 wire. (See fig. 2-12.)

(b) Lace the wires together.

(c) Strip off about 1/2 inch of wire insulation at the end to be soldered and twist the strands of wire to insure good contact.

(d) Place about 3/4 inch of phenoflex tubing over each wire leaving the ends bare until the wire is soldered.

(e) Solder each wire to one of the large female contacts of Plug PL-P172 or PL-Q172, using sufficient solder to fill the cup.

Note

Connect the wire from the No. 2 plug contact to the positive terminal of the battery in the final installation.

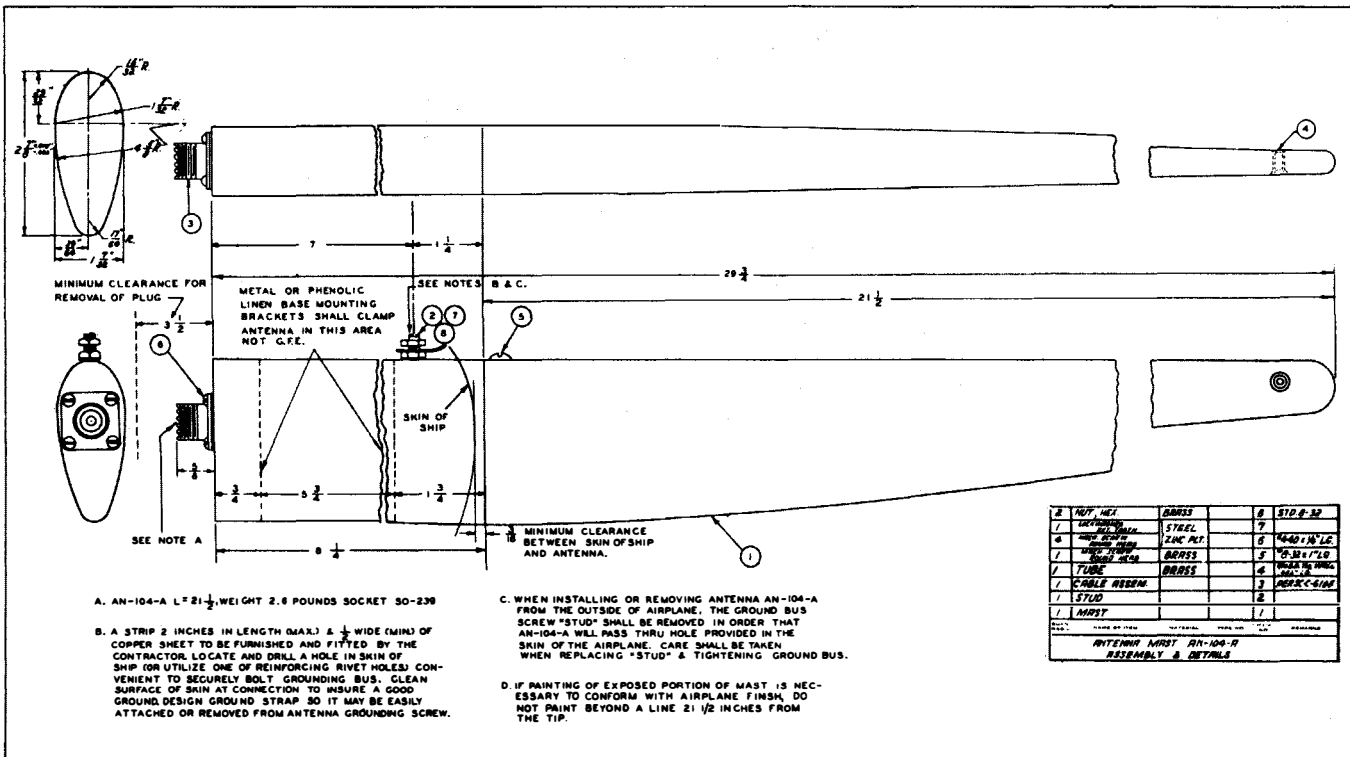

Figure 2-8. Antenna Mast AN-104-A—Outline Dimensions

(f) Slip the phenoflex tubing down over each soldered joint.

(g) Insert the plug assembly insulation in the plug body.

(h) Pass the female contacts through the center hole in the plug washer. Make certain that the contacts are seated in their grooves beside the center hole.

(i) Reinsert the plug washer with the female contacts in the plug body. The pin numbers on the plug washer must correspond with those on the face of the plug.

(j) Reinsert and tighten the two screws in the plug-assembly insulation.

(k) Reassemble the plug, reversing the procedure described in paragraph 3a(1), this section.

(2) PLUG PL-P173 OR PL-Q173.

(a) Cut coaxial cable to the proper lengths. Strip off the vinylite covering and shield.

(b) Cut the shield and roll it back over the sleeve. Remove the insulation.

(c) Push the rubber guard and the clamp over the cable. Push the sleeve over the shield until it is flush with the underneath sleeve.

(d) Slip the coupling nut over the metal contact pin. Insert the wire through the center opening, screw the contact pin into the clamp, and pull the wire taut. Solder and cut off the excess wire.

(3) PLUG PL-259.—Connect Plug PL-259 to one end of the required length of antenna cable (see fig. 2-12) as shown in figures 2-10 and 2-11.

(4) BAKELITE WIRE GUIDE TYPE PLUGS.

(a) Thread the wires through the proper holes in the bakelite wire guide.

(b) Strip off about $\frac{1}{2}$ inch of insulation at the ends of the wires to be soldered.

(c) Slip $\frac{3}{8}$ -inch phenoflex tubing over each wire.

(d) Solder the wires to the appropriate terminals.

(e) Place the plug in a corresponding socket.

(f) Push the bakelite wire guide onto the plug so that it engages the wire guide key.

(g) With a wrench, screw the locking ring tightly on the plug.

(5) REMAINING PLUGS.—Connect the remaining plugs to the required lengths of cable according to the instructions for Plug PL-P172 or PL-Q172 (depending on the type plug), but remove only $\frac{1}{4}$ inch of wire insulation.

4. CABLE CONNECTIONS.

Connect the components of the radio set according to the instructions given in the wiring diagrams, figures 2-12 and 2-13. The following specific instructions may be helpful when making connections to the jack box.

a. Remove the terminal lugs and turn for soldering, if necessary, by loosening the appropriate screws on the terminal strip inside the jack box with an offset screw driver. (If this tool is not available, remove the terminal strip mounting screws to take off the terminal strip.)

b. After connecting the necessary cables and wires to the jack box or jack boxes, fasten the lacing on the cables and wires to the anchor loop on the bottom of the jack boxes to take up slack and relieve the electrical connections of mechanical strain.

5. CIRCUIT PROTECTION DEVICES.

If it is desired to protect the aircraft primary power supply line to the set, a standard 20-ampere circuit breaker is recommended for the 28-volt power supply and a 40-ampere circuit breaker for the 14-volt power supply.

6. TESTING RADIO TRANSMITTER BC-625-A OR BC-625-AM (USING TEST EQUIPMENT IE-36).

If Test Equipment IE-36 is available, perform the following test to determine whether complete tuning of the transmitter is required. The following components of Test Equipment IE-36 are required for transmitter testing: Control Unit BC-1303, Phantom Antenna A-29, and Cord CD-1169. (See fig. 2-14.) A microphone of either carbon or dynamic type and Test Set I-139-A are also necessary.

a. Remove the transmitter and receiver covers by loosening the Dzus fasteners pinning them to the center cover. Raise the covers slightly and slide them away from the tuning controls.

b. Remove the cable connection from socket 417 of the rack and insert the 18-contact plug on the bottom of Control Unit BC-1303 into this socket.

CAUTION

Make certain the "SIG. GEN." and the "CONT." toggle switches at each end of the control unit and the "OFF ABCD" switch on the front panel are at "OFF."

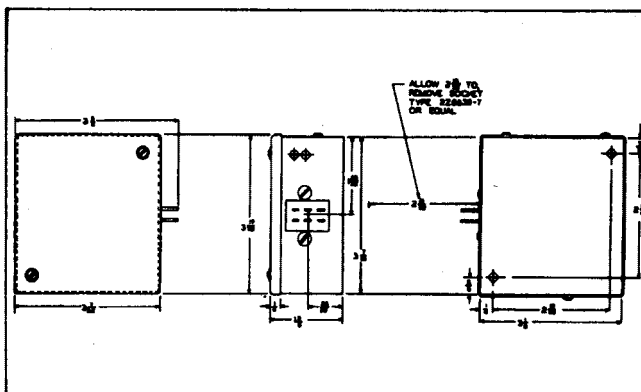

Figure 2-9. Microphone Adapter M-299
—Outline Dimensions

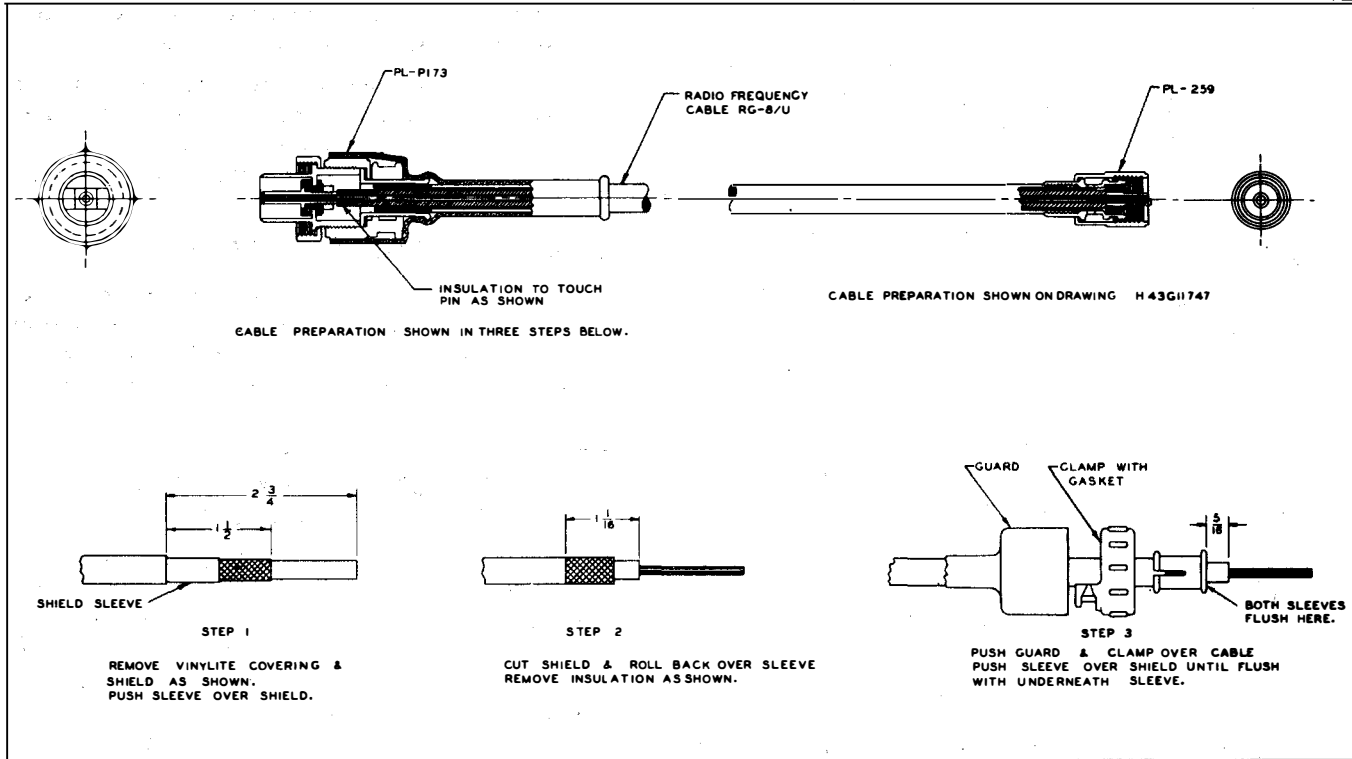

Figure 2-10. Cable Assembly With Plug PL-P173

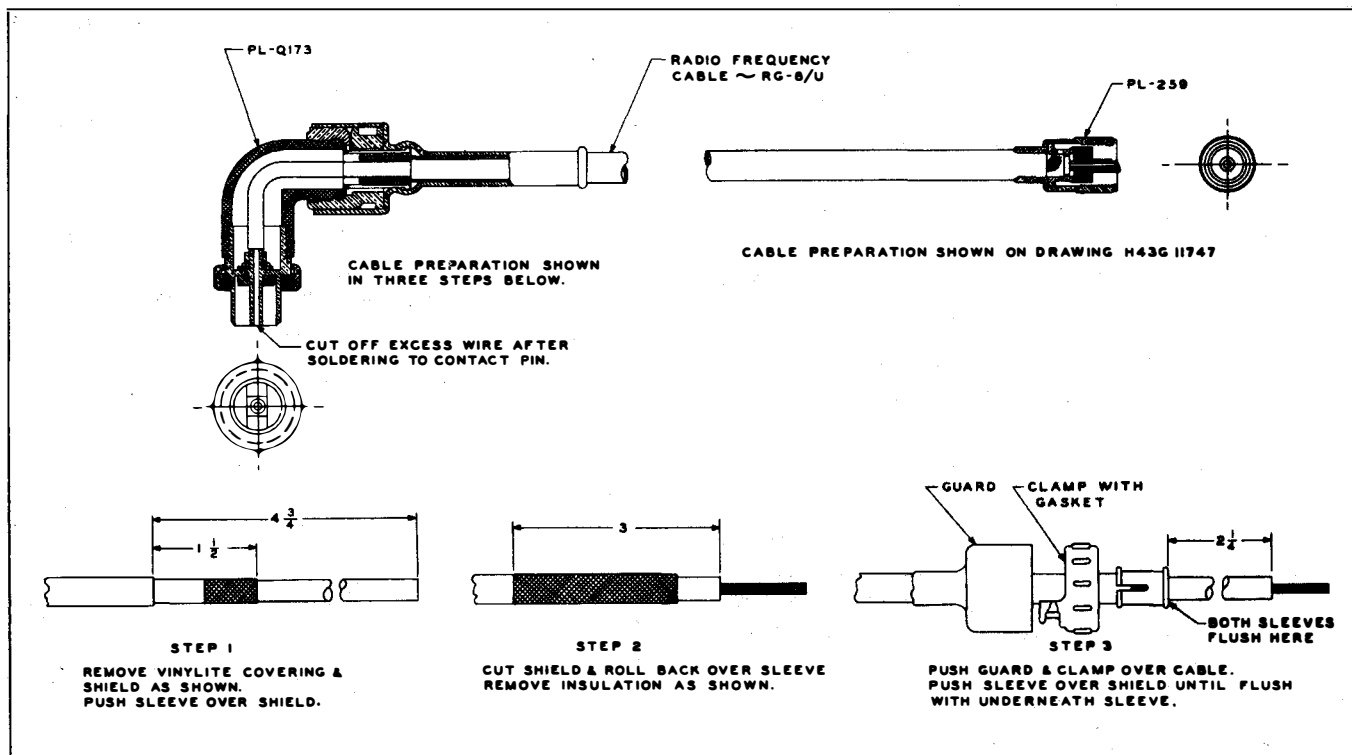

Figure 2-11. Cable Assembly With Plug PL-Q173

AN 16-40SCR522-2

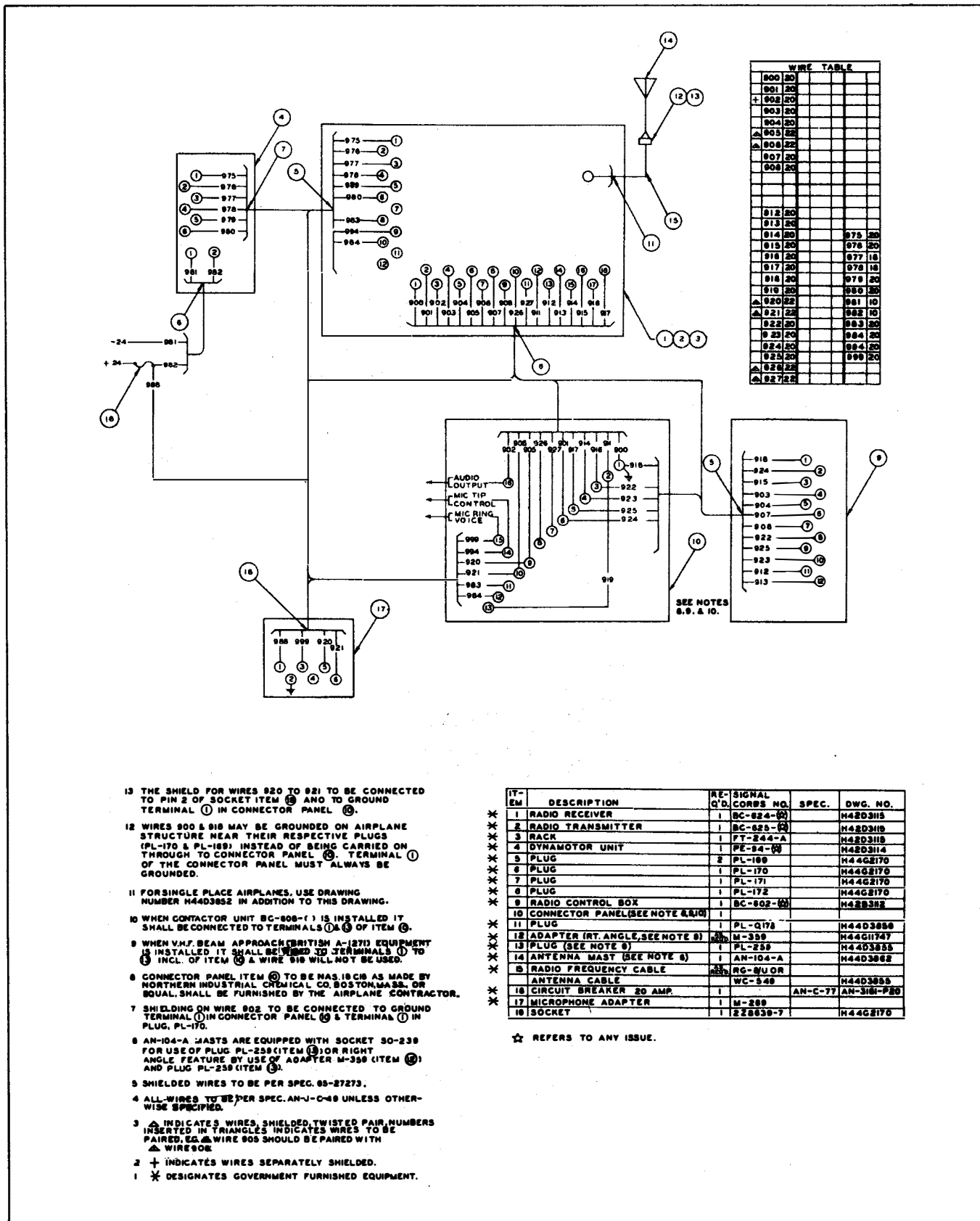

Figure 2-12. Radio Set SCR-522-A—Typical Wiring Diagram

AN 16-40SCR522-2

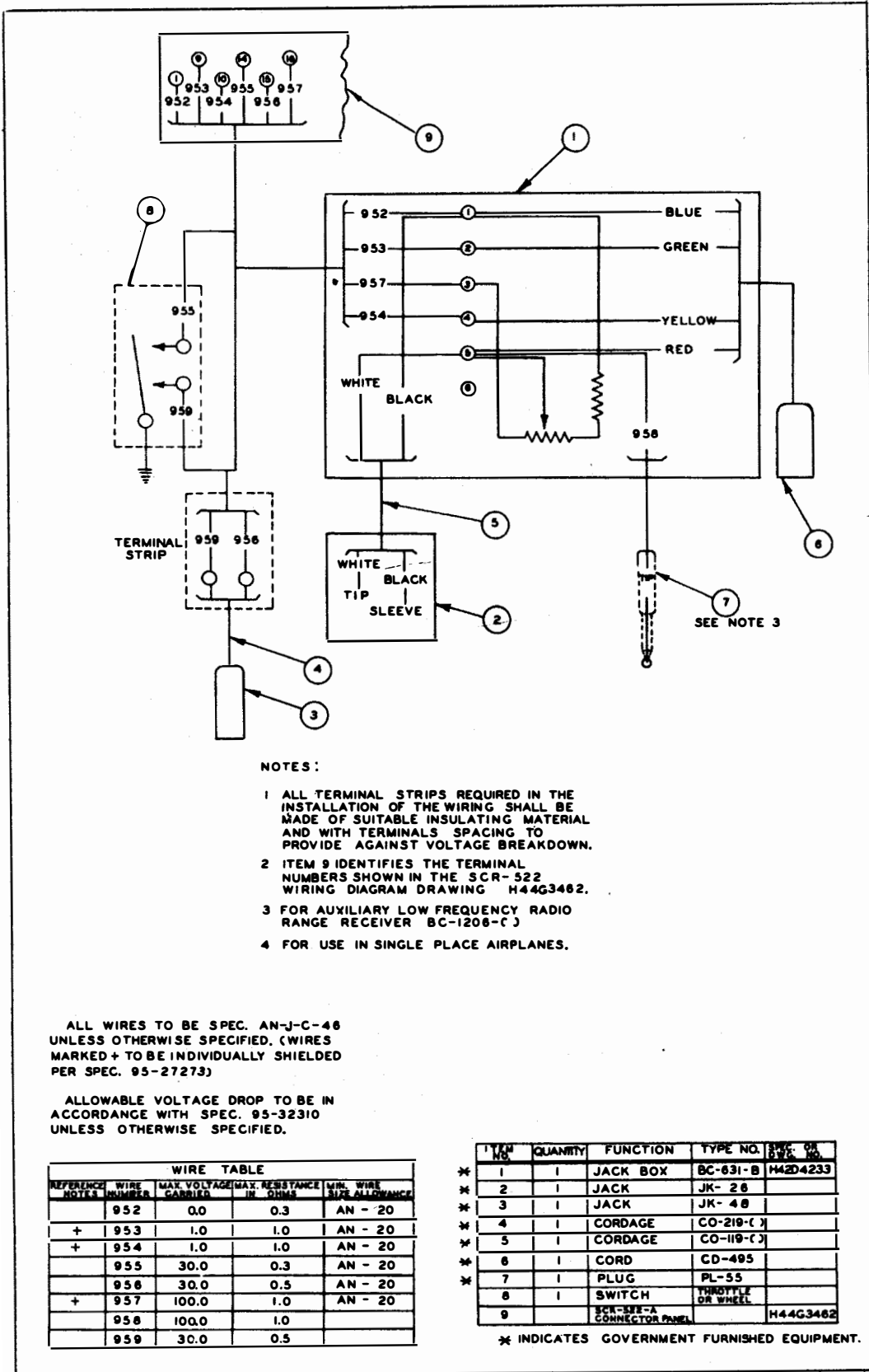

Figure 2-13. Jack Box BC-631-B—Typical Wiring Diagram

AN 16-40SCR522-2

c. Disconnect the cable of the airplane antenna from Socket SO-153 on Rack FT-244-A and plug Phantom Antenna A-29 into Socket SO-153 for test purposes.

d. Turn the "OFF ABCD" switch to "A." The dynamotor unit will start, and the frequency-shifter mechanism will operate, shifting the equipment to channel "A." Turn the switch to channels "B," "C," and "D" and observe the action of the shifter mechanism.

e. After allowing about 1 minute for the tubes to warm up, throw the "T-R-REM." switch on the control unit to the "T" position (or press the microphone press-to-talk button). The pilot lamp on the phantom antenna will light on all channels if the channels are tuned. If the lamp is dim or does not light on one or more channels, tuning is required. (Refer to par. 8, this sec.)

f. Insert the microphone plug in the "CAR. MIC." or the "MAG. MIC." jack on the control unit, depending upon the type of microphone being used. If a combination helmet headset and throat microphone is used, make the connection through Cord CD-1169. Plug the headset and microphone into Jack JK-49 on Cord CD-1169 and insert Plug PL-55 (attached to the cord marked "MIC.") into the "MAG. MIC." jack. Any combination of microphones and telephones found in the plane may be tested when using Cord CD-1169 directly connected to the control unit.

g. Whistle a sustained note into the microphone. If the carrier wave is being modulated, there will be an increase in the brilliance of the pilot lamp on the phantom antenna.

h. To test the operation of the contactor circuit, throw the "CONT." toggle switch located on the right-hand end of the control unit to the "ON" position. The frequency-shifter mechanism will shift the equipment to channel "D" for Radio Transmitter BC-625-A. For Radio Transmitter BC-625-AM, transmission will take place on the channel in use. The pilot lamp on the dummy antenna will light to show that transmission is occurring.

Note

Under these conditions a tone will be heard in the earphones. When the "CONT." switch is returned to "OFF," the equipment will shift back to the position at which it was operating before the switch was turned on, and the tone in the headset will no longer be heard.

i. Test the operation of the contactor circuit with the "T-R-REM." switch on the control unit in each position, using a different channel each time. In every case when the "CONT." switch is turned off, the mechanism will return to its original position when Radio Transmitter BC-625-A is used. Radio Transmitter BC-625-AM will remain in the same position. To be certain that tone modulated (MCW) transmission is taking place, first observe the pilot lamp on the phantom antenna with the control unit switches set as follows: the "OFF ABCD" switch at "D," the "T-R-REM." switch at "T," and the

"CONT." switch at "OFF." Now throw the "CONT." switch to "ON." An increase in brilliance of the pilot lamp in the phantom antenna shows that the carrier wave is being modulated and that the contactor signal will be transmitted.

j. To stop the transmitter, turn the "OFF ABCD" switch to the "OFF" position.

k. Remove Phantom Antenna A-29 from Socket SO-153 on Rack FT-244-A and reconnect the cable of the airplane antenna.

7. TRANSMITTER TUNING (USING TEST EQUIPMENT IE-19-()).**IMPORTANT**

For tuning do not remove the transmitter or the receiver from the case or from Rack FT-244-A.

a. EQUIPMENT REQUIRED.—The following test equipment is required for tuning the transmitter.

(1) Field Strength Meter I-95-() (Part of Test Equipment IE-19-()).

(2) Test Set I-139-A (Part of Test Equipment IE-19-()).

(3) Medium size screw driver.

IMPORTANT

To avoid excessive use of the storage battery of the airplane, use an external battery cart when tuning the transmitter or receiver.

b. INITIAL PROCEDURE. (See figure 2-1.)

Note

During the transmitter tuning procedure the radio set must be inside the case installed in the airplane; the airplane antenna must be connected.

(1) If the receiver and transmitter covers are closed, loosen the Dzus fasteners pinning them to the center cover. Raise the covers slightly and slide them away from the tuning controls.

(2) If crystals have not been previously installed, install crystals of the desired frequencies in the crystal sockets. (See table 5-4.) The crystal chosen for any transmitter channel should have a rated fundamental frequency one-eighteenth of the desired final output frequency. (Fundamental frequencies appear on the crystal holders.)

(3) Plug the cord of Test Set I-139-A into test meter socket 171 on the transmitter.

(4) Depress a channel selector push button on the radio control box. When a channel push button is pressed, the dynamotor will start and the frequency shifter mechanism will operate and shift the equipment to the channel selected. The switching mechanism will select and release channels in the sequence A, B, C, and D until the desired channel is selected.

Section II

Paragraph 7

AN 16-40SCR522-2

Note

If the shifter mechanism fails to operate when a channel selector push button on the radio control box is pressed, press another channel push button. Then press the button for the desired channel.

(5) Release the frequency shifter mechanism by pressing channel release button 426 or by pressing the armature of motor 406 once.

(6) Loosen the four transmitter tuning-control locknuts slightly by turning them counterclockwise.

Note

Avoid tuning to an undesired harmonic by making certain that all four tuning controls, when adjusted, indicate approximately the desired output frequency on the calibration plate.

c. TUNING OF FIRST CHANNEL.

(1) Press the channel release button 426 on the rack. This will release the channel previously selected.

(2) Allow about 1 minute for the tubes to warm up. Observe this by placing the transmitter "METER SWITCH" in position "3" and noting a rise of current in Test Set I-139-A.

(3) Throw the radio control box "T-R-REM." switch to "T." (or actuate the microphone press-to-talk switch).

(4) Place the transmitter "METER SWITCH" in position "1" and adjust the oscillator plate tuning control (first tuning control at left, as shown in fig. 2-1) for maximum reading on Test Set I-139-A.

(5) Repeat using "METER SWITCH" position "2" and the first harmonic amplifier plate tuning control.

(6) With the "METER SWITCH" in position "3," adjust the second harmonic amplifier plate control for a maximum reading and quickly adjust the power amplifier plate tuning control for a minimum reading on the test set. Record the readings.

d. TUNING REMAINING CHANNELS.

IMPORTANT

Before depressing the next channel push button, hold the channel controls with the fingers and tighten the locknuts just enough to exert a slight pressure on the car: pile-up. While doing this, make certain that the test set reading does not change.

(1) Depress the push button on the radio control box which follows the channel just tuned.

(2) Loosen all tuning-control locknuts.

(3) Follow the same tuning procedure outlined in paragraph 7c of this section.

(4) Tune the two remaining channels in like manner.

(5) Record the meter reading obtained on all four channels with the "METER SWITCH" in position "3."

(6) Depress the channel selector push button for the channel which had the highest meter reading with the "METER SWITCH" in position "3." If the meter reading is less than 0.60 or greater than 0.63, change the antenna coupling control as described below.

e. ADJUSTING ANTENNA COUPLING CONTROL (See figure 2-1.)

(1) LOCKING TYPE.

(a) If the reading is less than 0.6, increase the coupling by loosening the antenna coupling control thumbscrew and pushing it slightly toward the tuning controls. (See fig. 2-1.)

(b) Tighten the thumbscrew and adjust the fourth tuning control for a minimum reading on the test set.

(c) If the reading is more than 0.63, decrease the coupling by loosening the antenna coupling control thumbscrew and moving it slightly away from the tuning controls.

(d) Tighten the thumbscrew and adjust the fourth tuning control for a minimum reading on the test set.

(e) Repeat this procedure, alternately adjusting the thumbscrew and the fourth tuning control, until the correct meter reading is obtained.

(f) Do not consider a reading of more than 0.63 acceptable since such an adjustment will result in early tube failure.

(g) Record the meter reading finally obtained for later reference.

(2) NON-LOCKING TYPE. — The non-locking type antenna coupling control is a feature of the later models of Radio Transmitter BC-625-A. Adjust the control as follows:

(a) If the reading on the test set is less than 0.6, increase the coupling by rotating the control knob counterclockwise toward "MAX." (See fig. 2-1.)

CAUTION

Do not attempt to tighten the control knob as the knob serves only as an indicator of the relative position of the coupling coil. Do not turn the adjusting knob beyond "MAX" or "MIN" as damage to the equipment will result.

(b) Adjust the fourth tuning control for a minimum reading on the test set.

(c) If the reading is more than 0.63, decrease the coupling by turning the control knob clockwise toward "MIN."

(d) Adjust the fourth tuning control for a minimum reading on the test set.

(e) Repeat this procedure alternately adjusting the control knob and the fourth tuning control until a reading of approximately 0.63 is obtained on the test set.

(f) Record the meter reading for later reference.

f. FINAL TUNING.

(1) Retune the three remaining channels following the sequence in which the channels were originally tuned. Do not disturb the antenna coupling control.

Note

A reading of 0.50 on some channels is satisfactory.

(2) With all the channels tuned, press the channel release button. Carefully tighten the tuning-control locknuts with the fingers. If necessary, tighten with a tool but avoid exerting excessive pressure.

IMPORTANT

Tighten these locknuts properly or the tuning adjustments will not hold and the entire tuning procedure will have to be repeated.

(3) Make sure that all adjustments are securely locked by switching to each channel several times, and check the meter readings with the "METER SWITCH" in position "3" against those recorded while making the tuning adjustments.

g. TUNING CHECKS.

(1) With the tuning-control locknuts tightened and with the transmitter "METER SWITCH" in position "5," the meter reading for all channels should normally be full scale or more. Any reading greater than half-scale is satisfactory.

Note

On some equipments position "4" of the "METER SWITCH" is not used because of the elimination of the r-f indicator diode. (Refer to par. 8i, this sec.)

(2) With the "METER SWITCH" in position "3" and with any channel selected, rotate the fourth tuning control slightly against the positioning detent. Do not use excessive pressure. Repeat this check on each channel. If properly tuned, rotation in either direction will cause an increase in the meter reading.

Note

In general, meter readings greater than three-quarters full scale with the "METER SWITCH" in any one of its positions indicate a defect in the equipment or improper adjustment. An exception of this generalization occurs when the "METER SWITCH" is in position "5," when some of the vacuum tubes used may cause a full-scale or even off-scale reading, which is desirable.

(3) After tuning has been completed, tune in the unmodulated carrier on Field Strength Meter I-95(-).

Whistle a sustained note into the microphone. An increase in the reading on the milliammeter of the field strength meter should occur, which indicates modulation of the carrier.

Note

Position "6" is an off or open switch position.

b. TUNING SINGLE CHANNEL OUT OF ADJUSTMENT.—If one channel is known to be out of adjustment, it may be tuned without disturbing the other channels as follows:

(1) Press the channel-selector push button on the control box preceding the desired channel in the sequence "A," "B," "C," "D." (For example: if retuning channel "A," press push button "D;" if retuning channel "B," press push button "A," etc.)

(2) Press the channel release push button 426 on the rack. (See fig. 2-1.)

(3) Loosen all transmitter tuning-control locknuts, keeping slight pressure on the cam pile-up.

(4) Press the selector push button corresponding to the desired channel and completely loosen all tuning-control locknuts.

(5) Tune the desired channel. (Refer to pars. 7c (3) to (6), inclusive, this sec.)

(6) Press the channel release push button.

(7) Tighten all transmitter tuning-control locknuts with the fingers. If a tool is used, do not tighten locknuts excessively.

(8) Press the channel release push button 426 to reselect the channel just tuned.

(9) Check the meter reading for the highest loaded channel as determined from the readings recorded for all channels. If the reading is approximately 0.63, no adjustment of the antenna coupling is necessary. If it is less than 0.60 or more than 0.63 readjust the coupling on this channel in accordance with the instructions in paragraphs 7e(1) or (2), this section.

IMPORTANT

If the antenna coupling control is readjusted, reset the second harmonic amplifier plate and power amplifier plate tuning controls for the proper meter reading on all channels with the "METER SWITCH" in position "3." (Refer to par. 7c(6), this sec.)

i. TRANSMITTER "GAIN" CONTROL ADJUSTMENT.

Note

The transmitter "GAIN" control is usually locked at the factory and normally should not require adjustment. Make the following adjustment only if the "GAIN" control is not locked with glyptal or a locking nut. On later models of Radio Transmitter BC-625-AM, the

Section II

Paragraphs 7-8

AN 16-40SCR522-2

"GAIN" control has been replaced by a fixed resistance network and no adjustment is necessary.

Adjust the "GAIN" control (see fig. 2-1) with a screw driver for a setting of between 30° and 50° from the maximum clockwise position. Once made, this adjustment is good for all channels.

IMPORTANT

Never shut off the equipment with the shifter slides disengaged since this will result in failure to turn on the transmitter and receiver if a particular channel push button on Radio Control Box BC-602-B or BC-602-D is pressed.

8. TRANSMITTER TUNING (USING TEST EQUIPMENT IE-36).

a. EQUIPMENT REQUIRED.—The following equipment is required for transmitter tuning.

- (1) Test Equipment IE-36.
- (2) Test Set I-139-A.
- (3) Either Microphone T-17 (carbon) or Microphone T-44-() (magnetic).

b. INITIAL PROCEDURE.

Note

During the tuning procedure the radio transmitter must be inside the case with the radio receiver connected. If the transmitter is tuned

while it is outside the case, the additional capacitances introduced by returning it to the case will tend to upset the tuning adjustments.

(1) If the receiver and transmitter covers are closed, loosen the Dzus fasteners pinning them to the center cover. Raise the covers slightly and slide them away from the tuning controls as shown in figure 2-1.

(2) If the crystals have not been previously installed, install crystals of the proper frequency. (Refer to par. 7*b*(2), this sec.)

(3) Connect the airplane antenna in Socket SO-153 or Rack FT-244-A by means of a suitably prepared length of coaxial cable.

(4) Connect Control Unit BC-1303 (part of Test Equipment IE-36) to the rack by inserting the 18-contact plug on the bottom of the control unit into the 18-contact socket of the rack. Insert Test Set I-139-A in the transmitter meter socket 171.

c. TUNING CHANNEL "A"

(1) Turn the control unit "OFF ABCD" switch (fig. 2-15) to "D."

(2) Press channel release push button 426.

(3) Loosen transmitter tuning-control locknuts 1, 2, 3, 4, until they exert only a light pressure on the cam.

(4) Turn the control unit "OFF ABCD" switch to "A."

(5) Loosen the tuning-control locknuts completely.

(6) Turn the transmitter "METER SWITCH" to position "3" and check the test set for a reading of from 0.4 to 0.63.

(7) Throw the "T-R-REM." switch on the control unit to "T" (or actuate the microphone press-to-talk switch).

(8) Avoid tuning to an undesired harmonic by making certain that when all four tuning controls are adjusted, they indicate approximately the desired-output frequency on the calibration plate. Check to see that the proper crystals are installed.

(9) Turn the transmitter "METER SWITCH" to position "1." Adjust the oscillator plate tuning control for a maximum reading on the test set by turning the indicator plate under the locknut either to the left or right.

(10) Turn the transmitter "METER SWITCH" to position "2" and adjust the first harmonic amplifier plate tuning control for a maximum meter reading.

(11) Turn the transmitter "METER SWITCH" to position "3" and adjust the second harmonic amplifier plate tuning control for maximum meter reading, and immediately adjust the power amplifier plate tuning control for a minimum meter reading.

(12) If the meter readings in preceding steps (10) and (11) are more than 0.63, adjust the antenna coupling control according to directions in paragraph 7*e*(1)



Figure 2-14. Test Equipment IE-36

AN 16-40SCR522-2

or (2), this section. Reset the tuning controls as directed in paragraph (10) and (11) above, and adjust the antenna coupling control for a reading of 0.63 as directed in paragraphs 7e(1) or (2), this section.

d. ADJUSTING REMAINING CHANNELS.

(1) To tune channel "B," turn the "OFF ABCD" switch on the control unit to "B" (fig. 2-15) and follow the same tuning procedure outlined for channel "A" in paragraph 8c, this section. However, do not change the antenna coupling adjustment unless the meter reading is more than 0.63. Tune channels "C" and "D" in like manner.

(2) Press the channel release button 426 and tighten the locknuts on the tuning adjustments.

e. CURRENT CHECKS.

(1) With the tuning control locknuts tightened and the transmitter "METER SWITCH" in position "5," the

meter reading for all channels should normally be full-scale (0 to 1) or more. Any reading greater than half-scale (.5 or more) is satisfactory. If this condition is not achieved for any channel, readjust the second harmonic amplifier plate tuning control for a maximum meter reading with the "METER SWITCH" in position "5," and retune that particular channel by following the procedure outlined in paragraph 8c, this section.

(2) With the tuning control locknuts tightened, there is a positioning detent which makes it possible to turn the tuning controls slightly in either direction against spring pressure. In some cases a large amount of torque is necessary to rotate the controls. Tuning controls 1, 2, and 3 can be checked by rotating them in both directions against the positioning detent and by noting that maximum meter reading occurs in the resting position of the control. If the meter reading is not at maximum in the resting position, retune that particular control in accordance with paragraph 8g below.

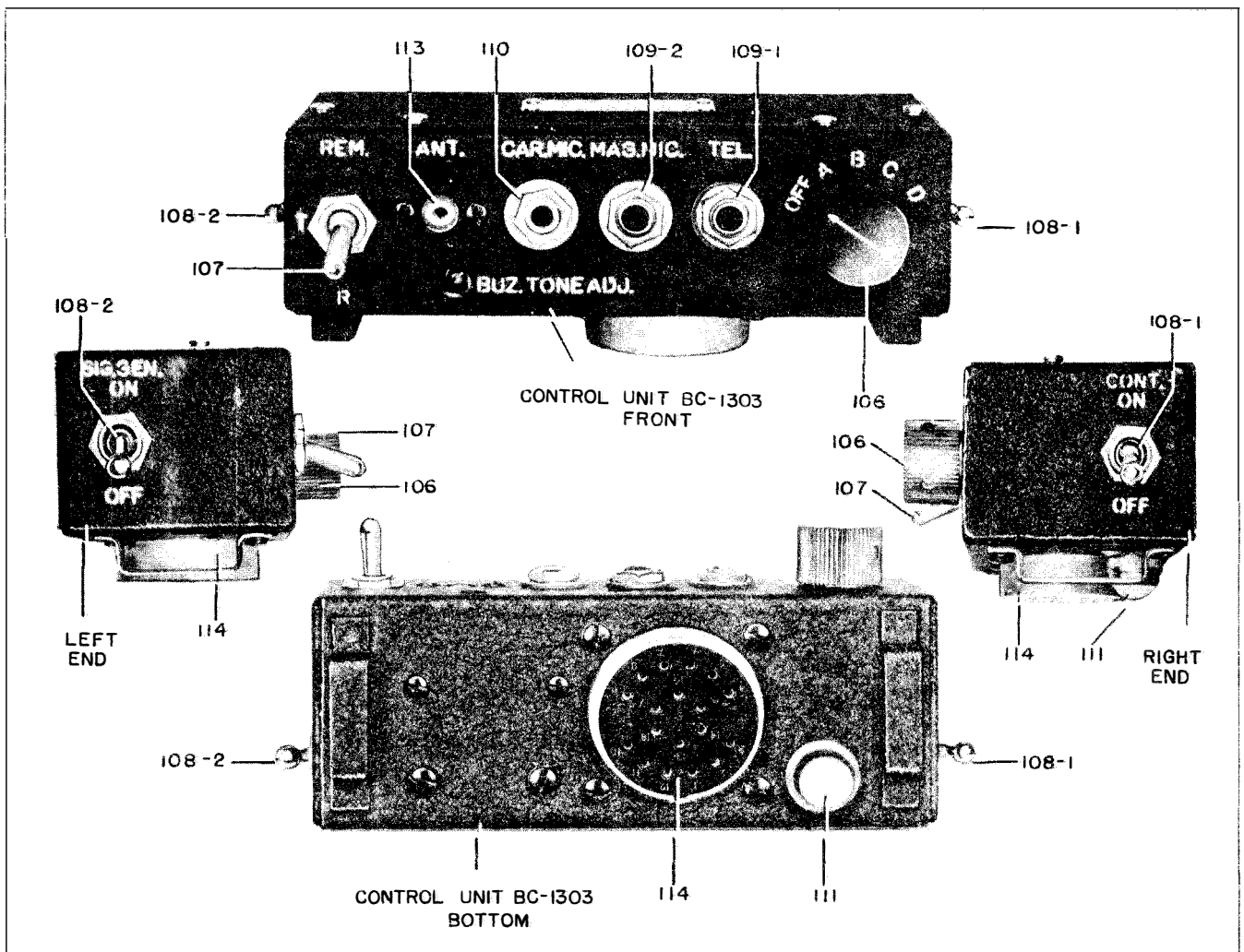

Figure 2-15. Control Unit BC-1303 (Part of Test Equipment IE-36)

Section II

Paragraph 8

AN 16-40SCR522-2

CAUTION

Do not exert excessive pressure against the detent.

f. FINAL MODULATION CHECK.

Note

Do not retune during this check.

(1) Remove the cable of the airplane antenna from Socket SO-153 on Rack FT-244-A and install Phantom Antenna A-29 in Socket SO-153.

(2) Plug in the microphone. (Refer to par. 6f, this sec.)

(3) Whistle a sustained note into the microphone and note the action of the pilot lamp on the phantom antenna. If the carrier wave is being modulated properly, there will be an increase in brilliance in the lamp of the phantom antenna.

(4) Remove Phantom Antenna A-29 and connect Antenna Mast AN-104-A or AN-104-B to Socket SO-153 by means of the antenna cable.

Note

Never turn off the radio set with the shifter slides disengaged since this will result in failure to turn on the transmitter and receiver if one particular channel push button on Radio Control Box BC-602-B or BC-602-D is pressed.

g. TUNING ONE CHANNEL ONLY. — If it is known that one channel is out of adjustment, it may be tuned without disturbing the other channels. (Refer to par. 8c, this sec., for directions on tuning a single channel.) The following is a brief summary of procedure.

(1) Turn the control unit "OFF ABCD" switch to the channel preceding the desired channel in the sequence "A," "B," "C," "D," etc.

(2) Press channel release push button 426 on Rack FT-244-A.

(3) Loosen all transmitter tuning-control locknuts.

(4) Turn the "OFF ABCD" switch to the desired channel.

(5) Tune the desired channel (refer to par. 8c, this sec.)

(6) Press the channel release push button.

(7) Tighten all transmitter tuning-control locknuts 1, 2, 3, 4.

(8) Press the channel release push button.

(9) Check the meter reading on the lowest frequency channel. If this reading is approximately 0.63, do not adjust the antenna coupling control. If it is less than 0.60 or more than 0.63, adjust the coupling on this channel in accordance with the instructions in paragraph 7e(1) or (2), this section.

b. TRANSMITTER "GAIN" CONTROL ADJUSTMENT.—Adjust the "GAIN" control (125) for a set-

ting of 30° to 50° from the extreme clockwise position.

Note

In all cases, the point of proper adjustment of the "GAIN" control is that which gives maximum volume without excessive distortion in a second receiver. This adjustment, once made, is good for all channels. In late models of the transmitter, the "GAIN" control has been locked with glyptal at the point of proper operation when magnetic microphones are to be used, and in later models of Radio Transmitter BC-625-AM the "GAIN" control has been replaced by a fixed resistance network and no adjustment is necessary.

i. SIGNIFICANCE OF METER READINGS.

(1) In general, a meter reading on Test Set I-139-A which is greater than 0.63 with the transmitter "METER SWITCH" in position "1," "2," or "3" indicates a defect in the equipment or improper adjustment. The following chart indicates the significance of meter readings.

Position	Normal	Trouble
"1"	0.4	Greater than .63
"2"	0.5	Greater than .63
"3"	0.63	Greater than .63
(Average for channels "A," "B," "C," "D")		
"4"*		
"5"	Full scale	Less than .5
"6"	Off	

*In some radio sets r-f diode current is measured with the "METER SWITCH" in position "4". This switch position is seldom used. The reading obtained is purely relative, without quantitative significance, and is equivalent to a neon-bulb indication of r-f voltage across the final amplifier tank inductor.

(2) The reading obtained on the test set with the "METER SWITCH" in position "5" is another variable quantity. Transmitting tube data sheets describe grid "drive" or grid current as approximate, subject to wide variations depending on the impedance of the load circuit. It is desirable that this current be as large as possible (even off-scale) but this is not possible with some of the tubes being used. The real test of satisfactory adjustment is whether or not *upward modulation* of the carrier results.

(3) It is reasonable to assume that half-scale or higher meter readings, with the "METER SWITCH" in position "5," are satisfactory.

(4) It should be noted that there is an "idle" or standing plate current resulting in a meter reading of approximately 0.4 when the "METER SWITCH" is in position "3" and the radio set is in the receive condition. This is normal and correct and indicates the existence of a load on the modulator at all times. If this current is abnormally high, an open or short circuit is indicated in the -150-volt bias supply from the dynamotor unit.

(5) With the "METER SWITCH" in position "4," it should be noted that there is a small emission current in the r-f diode in the "standby" condition. (Position "4" will also be an open switch position on sets in which the r-f indicator diode has been omitted.)

(6) Position "6" of the "METER SWITCH" is an off or open switch position.

9. TESTING RADIO RECEIVER BC-624-A, BC-624-AM, OR BC-624-C* (USING TEST EQUIPMENT IE-36).

If Test Equipment IE-36 is available, perform the following test to determine whether complete tuning of the receiver is required.

a. The following components of Test Equipment IE-36 (see fig. 2-14) are required for receiver testing: Control Unit BC-1303, Cord CD-1169, and Cord CD-1170. A suitable headset is also necessary.

Note

The radio receiver must be in the case during the test.

b. Connect the control unit (see fig. 2-15) to the rack according to directions in paragraph 6b, this section. Insert the pin probe of Cord CD-1170 into the "ANT" pin jack on the control unit. Disconnect the antenna cable from Socket SO-153 on Rack FT-244-A and clip the alligator clip on the end of Cord CD-1170 to the center pin of Socket SO-153. Insert the plug from the headset into Jack JK-49 of adaptor Cord CD-1169, and insert Plug PL-55 (attached to cord marked "TEL") into the "TEL" jack of the control unit.

c. Turn the "OFF ABCD" switch on the control unit (fig. 2-15) to "A." The dynamotor will start and the frequency shifter mechanism will shift the equipment to channel "A." If the mechanism does not shift, turn the "OFF ABCD" switch to another channel and then switch back to "A." Now, try channels "B," "C," and "D" and observe the action of the mechanism. Shift the equipment to channel "A."

d. After allowing about 1 minute for the tubes to warm up, throw the "T-R-REM." switch on the control unit to "R."

e. Turn the "SIG. GEN." switch located on the left-hand end of the control unit to "ON." If the receiver channels have been tuned, the buzzer signal will be heard in the phones. The signal will be slightly less in volume for Radio Receiver BC-624-AM than for Radio Receiver BC-624-A.

Note

The buzzer tone can be adjusted by use of a screw driver through the hole marked "BUZ. TONE ADJ." on the front of the control unit.

f. Turn the "OFF ABCD" switch to "B," "C," and "D" noting the signal in the phones. If the signal is

relatively weak or absent on one or more channels, tuning is required. (Refer to par. 10 or 11, this sec.) If the signal is too loud, make tests with the alligator clip on Cord CD-1170 removed from the center pin of Socket SO-153 of the rack and with the cord left hanging from the control unit.

Note

Only relative output of the receiver can be judged by the intensity of the signal. However, by using the same control unit a comparison can be made between a set known to be in good working order and the set under test.

g. Turn the channel selector switch to the "OFF" position.

10. RECEIVER TUNING (USING TEST EQUIPMENT IE-19-()) .

a. EQUIPMENT REQUIRED.—The following equipment is required for receiver tuning.

- (1) Test Equipment IE-19-().
- (2) Headset.
- (3) Medium size screw driver.

b. INITIAL PROCEDURE.—If the receiver cover is shut, loosen the Dzus fasteners pinning it to the center cover, lift the receiver cover slightly, and slide it away from the control panel.

c. CRYSTAL SELECTION.

(1) A receiver crystal is identified by the fundamental frequency in kilocycles which appears on the crystal holder.

(2) Finding the correct receiver crystal for a particular receiver channel is therefore the same as finding the correct fundamental frequency in kilocycles of the crystal to be used. The fundamental crystal frequency f may be determined from the following expression where f_r is the frequency in megacycles to which the receiver is to be tuned and H is the receiver crystal harmonic used.

$$f = \frac{f_r - 12}{H} \times 1000$$

The receiver crystal harmonic (H) used depends only on the frequency (f_r) to be tuned in, and is given in the following table.

Frequency (f_r) (Megacycles)	Receiver Crystal Harmonic (H)
100 to 108	11
108 to 116	12
116 to 124	13
124 to 132	14
132 to 140	15
140 to 148	16
148 to 156	17
156	18

*When tuning Radio Receiver BC-624-C, rotate the "SQUELCH" control to the maximum clockwise position actuating the switch which will render the noise limiter switch inoperative.

Section II

Paragraph 10

AN 16-40SCR522-2

d. ADJUSTMENT OF SIGNAL GENERATOR I-130-A.

(1) USING CRYSTAL.

(a) Insert a transmitter crystal having a fundamental frequency one-eighteenth of the receiver frequency to be tuned in the "CRYSTAL" socket of Signal Generator I-130-A, part of Test Equipment IE-19(). If no transmitter crystal is available, refer to paragraphs 10d(2), 10e(2), and 10f(2), this section.

(b) Connect Cord CD-477, part of Test Equipment IE-19-(), to the signal generator "R.F. OUTPUT" socket and to the antenna Socket SO-153 located on Rack FT-244-A. Connect Test Set I-139-A to the signal generator "METER" socket.

(c) Plug the cable of Battery Box BX-33-A, part of Test Equipment IE-19-(), into the signal generator four-pin socket located to the left of the "METER" socket. Throw the signal generator "POWER ON-OFF" switch to "ON."

(d) Set the signal generator "M.O.-CRYSTAL" switch to "CRYSTAL."

(e) Place the "OUTPUT CONTROL" on "MAX" (extreme clockwise position) and place the "OUTPUT STEPS" control on step "5."

(f) After allowing about 1 minute for the tubes to warm up, adjust the "CRYSTAL TUNING" control to the frequency to be tuned. If this adjustment is correct, a small dip will be observed in the test set.

(g) Adjust the "MEGACYCLES" dial control on the signal generator for an additional dip (approximately at the same dial setting as the receiver channel frequency being tuned).

(2) USING MASTER OSCILLATOR. — Use the same procedure for employing the signal generator master oscillator as the procedure for employing the crystal oscillator except for the following:

(a) Do not touch the "CRYSTAL TUNING" control.

(b) Set the "M.O.-CRYSTAL" switch at "M.O."

(c) Tune the signal generator by means of the "MEGACYCLES" dial control only.

e. TUNING CHANNEL "A."

(1) USING CRYSTAL IN SIGNAL GENERATOR.

(a) Install the proper crystal in the socket for receiver channel "A." (See fig. 2-1.)

(b) Press channel "D" push button of Radio Control Box BC-602-B or BC-602-D.

Note

If the receiver fails to operate when a channel push button on the radio control box is pressed, press another channel push button, then again press the push button for the desired channel.

(c) Press the channel release push button 426 located on the rack. (See fig. 2-1.)

(d) Loosen the two receiver tuning-control locknuts by turning them counterclockwise. Tighten the two locknuts just enough to exert a slight pressure on the cam pile-up. Otherwise vibration may change the position of the cam, and introduce considerable setup error.

(e) Press channel "A" push button of the radio control box and completely loosen all tuning control locknuts. After allowing about 1 minute for the receiver vacuum tubes to warm up, throw the radio control box "T-R-REM." switch to "R." (If Radio Control Box BC-602-D is in use, the equipment is normally in the receiver position.)

(f) Turn the receiver r-f and oscillator tuning controls to the desired frequency on the calibration plate.

(g) Connect a suitable headset across the audio output terminals on the jack box. Rotate the receiver "AUDIO" and "RELAY" or "SQUELCH" controls to their maximum clockwise rotation positions.

(b) Starting from the extreme clockwise position, slowly turn the channel "A" oscillator plate coil tuning screw counterclockwise so that about three to five threads of the screw protrude from the coil-mounting insert. The higher the crystal frequency the further the crystal plate coil screw must be backed out of the coil-mounting insert to obtain the necessary inductance to permit the oscillator to start. When the oscillator starts, a signal should be heard.

(i) If there is no audible signal, simultaneously adjust the receiver r-f and oscillator tuning controls slightly, and if necessary, turn the channel "A" oscillator plate coil tuning screw still further counterclockwise until the signal is heard.

(j) When the signal is heard, rotate the oscillator plate coil tuning screw clockwise until the signal suddenly ceases; then rotate the screw counterclockwise to a position at least three-quarters of a turn past the point at which the signal again becomes audible (i.e., the position at which the oscillator starts). The additional three-quarters of a turn is required for stable adjustment of the crystal oscillator. If the output is decreased appreciably by this extra rotation, continue turning the screw counterclockwise until a second peak is reached. If this second peak signal is greater than the signal heard at the $\frac{3}{4}$ counterclockwise turn, leave the tuning screw in this position. If the signal is less, return the tuning screw to the $\frac{3}{4}$ position.

(k) Turn the "OUTPUT CONTROL" on the signal generator to "MIN." Place the "OUTPUT STEPS" control to position "1" or "2." Turn the "OUTPUT CONTROL" clockwise until the signal is just audible.

(l) Adjust the receiver tuning controls and the signal generator "CRYSTAL TUNING" control for maximum audio output. Rotate the "OUTPUT CON-

TROL" counterclockwise, if necessary, to keep the peaked output at low level in the headset. This may require repeated readjustments.

Note

Final tuning adjustments may be made using an output meter or an a-c voltmeter connected in parallel with the headset or using Test Set I-139-A plugged into socket 288 on the receiver. If the output meter or a-c voltmeter is used, the receiver tuning controls are adjusted for maximum audio output. If Test Set I-139-A is used, the receiver tuning controls are adjusted for a minimum reading on the test set.

**(2) USING MASTER OSCILLATOR
IN SIGNAL GENERATOR.**

(a) Press channel "D" push button of Radio Control Box BC-602-B or BC-602-D.

Note

If channel "A" has already been selected, channels "B" and "C" will be switched on and off before channel "D" is reached.

(b) Press channel release push button 426.

(c) Loosen the two receiver tuning-control locknuts by turning them counterclockwise. Tighten the locknuts just enough to exert a slight pressure on the cam pile-up.

(d) Press channel "A" push button of the radio control box and completely loosen all tuning-control locknuts. After allowing about one minute for the receiver vacuum tubes to warm up, throw the radio control box "T-R-REM," switch to "R." (If Radio Control Box BC-602-D is in use, the equipment is normally in the receive position.)

(e) Turn the receiver r-f and oscillator tuning controls to the desired frequency on the calibration plate.

(f) Using the alignment tool or a small screw driver, turn the crystal oscillator plate coil tuning screw for channel "A" to the position at which about three to five threads protrude from the coil-mounting insert. The higher the crystal frequency the further the plate coil screw must be backed out of the coil-mounting insert to obtain the necessary inductance to permit the oscillator to start.

(g) With a suitable headset connected to the audio output terminals in the jack box, place the signal generator "OUTPUT STEPS" control on step "5" and set the "OUTPUT CONTROL" at "MAX" (extreme clockwise position).

(h) Set the signal generator "MEGACYCLES" dial control at the frequency being tuned and then adjust the receiver tuning controls until the modulated signal is heard in the headphones. This may require several readjustments.

(i) Turn the oscillator plate coil tuning screw for channel "A" clockwise until the modulated signal suddenly ceases.

(j) Turn the oscillator plate coil tuning screw counterclockwise until the signal is heard again. An additional three-quarters of a full turn in a counterclockwise direction is necessary for a stable adjustment of the crystal oscillator. If this results in reduced output, continue turning the screw counterclockwise until a second peak is reached. If this second peak signal is greater than the signal heard at the $\frac{3}{4}$ counterclockwise turn, leave the tuning screw in this position. If the signal is less, return the tuning screw to the $\frac{3}{4}$ position. Check after completing steps (k) and (l) below.

(k) Turn the signal generator "OUTPUT CONTROL" to "MIN." Place the "OUTPUT STEPS" control in position "1" or "2." Turn the "OUTPUT CONTROL" clockwise until the signal is just audible.

(l) Adjust the receiver tuning controls and the signal generator "MEGACYCLES" dial control for maximum audio output. Rotate the "OUTPUT CONTROL" counterclockwise, if necessary, to keep the peaked output at a low level in the headset. The final setting of the receiver tuning controls should be near the calibrated settings for the desired frequency.

f. TUNING REMAINING CHANNELS.

**(1) USING CRYSTALS IN
SIGNAL GENERATOR.**

IMPORTANT

Before depressing push button "B," hold the tuning controls with the fingers and tighten the locknuts just enough to exert a slight pressure on the cam pile-up. While doing this, make certain that the audio output level remains constant.

(a) Press channel "B" push button on Radio Control Box BC-602-B or BC-602-D and completely loosen all tuning control locknuts.

(b) Follow the same tuning procedure outlined for channel "A" in the paragraphs under 10e(1), this section.

Note

The tuning instructions for channel "A" apply to channel "B" if the letter "B" is substituted for "A" wherever the crystal, the channel, and the oscillator plate coil tuning screw are mentioned. This note is equally applicable when tuning channels "C" and "D."

(c) Tune channels "C" and "D" in a like manner.

(d) Press the channel release push button and tighten the two receiver tuning-control locknuts by turning them tightly clockwise with the fingers.

(e) Check all channels for satisfactory receiver output.

Section II

Paragraph 10

AN 16-40SCR522-2

(2) USING MASTER OSCILLATOR IN SIGNAL GENERATOR.

IMPORTANT

Before depressing push button "B," hold the tuning controls with the fingers and tighten the locknuts just enough to exert a slight pressure on the cam pile-up. While doing this, make sure that the audio output level does not change.

(a) Press channel "B" push button on Radio Control Box BC-602-B or BC-602-D and completely loosen all tuning control locknuts.

(b) Follow the same tuning procedure outlined for channel "A" in the paragraphs under 10e(2), this section.

Note

The tuning instructions for channel "A" apply to channel "B" if the letter "B" is substituted for "A" wherever the crystal, the channel, and the oscillator plate-coil tuning screw are mentioned. This note is equally applicable when tuning channels "C" and "D."

(c) Tune channels "C" and "D" in a like manner.

(d) Press the channel release push button and tighten the two receiver tuning-control locknuts by turning them slightly clockwise with the fingers.

(e) Check all channels for satisfactory receiver output.

g. TUNING SINGLE CHANNEL OUT OF ADJUSTMENT.—If the channel is known to be out of adjustment, it may be tuned without disturbing the other channels as follows:

(1) Press the push button on the radio control box corresponding to the channel preceding the desired channel in the sequence "A," "B," "C," and "D." (For example: If retuning channel "B," press push button "A;" if retuning channel "A," press push button "D," etc.)

(2) Press the channel release push button.

(3) Loosen the receiver tuning-control locknuts, keeping a slight pressure on the cam pile-up.

(4) Press the channel-selector push button for the desired channel and completely loosen all tuning control locknuts.

(5) Tune the desired channel. (Refer to par. 10e(1) if a crystal is used in the signal generator; refer to par. 10e(2) if no crystal is used.) Ignore reference to channel "A" and substitute the applicable letter.

(6) Press the channel release push button.

(7) Tighten the receiver tuning-control locknuts with the fingers.

(8) Press the channel release push button 426 to reselect the channel just tuned.

(9) Recheck all channels for satisfactory receiver output.

b. TUNING CHECKS.

(1) Make certain that the tuning-control locknuts are tightened.

(2) Tune in a signal from a source such as Test Equipment IE-36 or IE-19-().

(3) Rotate either receiver tuning control clockwise and then counterclockwise. If there is a decrease in the signal as the control is rotated in either direction, the receiver is tuned correctly.

(4) If the signal increases as the receiver tuning control is rotated in either direction, retune the receiver.

IMPORTANT

Never turn off the equipment with the shifter slides disengaged since this will result in failure to turn on the transmitter and receiver if one particular channel push button on Radio Control Box BC-602-B or BC-602-D is pressed.

i. RECEIVER "AUDIO" CONTROL ADJUSTMENT.

(1) Receiver output transformer 296 is provided with three impedance taps; terminal No. 5, 50 ohms; No. 6, 300 ohms; and No. 7, 4000 ohms. In some equipments, the output lead is connected to terminal No. 6 and in others to terminal No. 7. In Radio Receiver BC-624-C the 80-ohm tap is terminal #4 and the 800-ohm tap is terminal #5 on transformer 200.

(2) The exact setting of the "AUDIO" volume control (see fig. 2-1) depends on the volume desired by the pilot. However, when using Radio Receiver BC-624-A never advance the "AUDIO" control on the receiver beyond three-quarters or seven-eighths of its maximum rotation. When using Radio Receiver BC-624-AM or BC-624-C, set the "AUDIO" control in the extreme clockwise position.

(3) After adjusting the "AUDIO" control on the receiver according to the directions in paragraph (2) above, increase or decrease the volume, as desired, by the "AUDIO" control on Jack Box BC-629-B or BC-631-B.

j. RECEIVER "RELAY" OR "SQUELCH" CONTROL ADJUSTMENT.

Note

The "RELAY" control has been replaced by the "SQUELCH" control in Radio Receiver BC-624-C.

(1) The "RELAY" or "SQUELCH" control adjustment is the last adjustment to be made on the receiver. Make this adjustment with the antenna connected, the equipment operating on any tuned channel, and with no signal being received.

(2) Rotate the "RELAY" or "SQUELCH" control (see fig. 2-1) to the extreme clockwise position. Turn it slowly counterclockwise until a noticeable drop in noise

results and continue the counterclockwise rotation for a very small fraction of a turn. Normally, make this adjustment when the engines are not running.

(3) If the adjustment has been checked and the pilot still complains of excessive noise in the phones at all times, adjust the "RELAY" or "SQUELCH" control while the engines are running, but omit the small fraction of a turn mentioned in preceding step.

11. RECEIVER TUNING (USING TEST EQUIPMENT IE-36 AND A SUITABLE HEADSET).

a. TUNING CHANNEL "A."

(1) Loosen the Dzus fasteners pinning the receiver cover to the center cover, lift the receiver cover slightly, and slide it away from the control panel.

(2) If crystals have not been previously inserted, install the proper crystal in the crystal socket for receiver channel "A." (Refer to par. 10c, this sec.)

(3) Set up Test Equipment IE-36 (see fig. 2-14) according to directions in paragraph 9b, this section.

(4) Turn the "OFF ABCD" switch on Control Unit BC-1303 (see fig. 2-15) to "D." This is the channel preceding the channel to be tuned channel "A". (Refer to par. 8c, this sec.)

(5) Press the channel release push button 426 located on the rack.

(6) Loosen the two receiver tuning control locknuts by turning them counterclockwise. Tighten the locknuts just enough to exert slight pressure on the cam pile-up; vibration may introduce considerable setup error by changing the position of the cam.

(7) Turn the "OFF ABCD" switch to "A" and completely loosen the two receiver tuning-control locknuts. After allowing about 1 minute for the receiver vacuum tubes to warm up, throw the control unit "T-R-REM." switch to "R." Turn the noise limiter switch (part of the "SQUELCH" control) off if Radio Receiver BC-624-C is in use.

IMPORTANT

Avoid tuning to an undesired harmonic by making certain that the receiver r-f and oscillator tuning controls are turned to the desired frequency on the calibration plate. An error of more than ± 3 megacycles may mean that the receiver is operating approximately 8 megacycles removed from the operating frequency.

(8) Turn on the "SIG. GEN." switch located at the left end of the control unit, and rotate the "AUDIO" and "RELAY" or "SQUELCH" controls on the receiver to their maximum clockwise rotation positions.

(9) Starting from the extreme clockwise position, slowly turn the oscillator plate coil tuning screw adjustment "A" (see fig. 2-1) counterclockwise so that about three to five threads of the screw protrude from the coil-

mounting insert. The higher the crystal frequency the further the plate coil screw must be backed out of the coil-mounting insert to obtain the necessary inductance to permit the oscillator to start. When the oscillator starts a signal should be heard in the phones.

(10) If there is no audible signal, simultaneously adjust the receiver r-f and oscillator tuning controls slightly, and if necessary, turn the channel "A" oscillator plate coil tuning screw still further counterclockwise until the signal is heard. When the signal is heard, rotate the oscillator plate coil tuning screw "A" clockwise until the signal suddenly ceases; then rotate the screw counterclockwise to a position at least three-quarters of a turn past the point at which the oscillator starts. The additional three-quarters of a turn is required for a stable adjustment of the crystal oscillator. If the output is decreased appreciably by this extra rotation, continue turning the screw counterclockwise until a second peak is reached. If this second peak signal is greater than the signal heard at the $\frac{3}{4}$ counterclockwise turn, leave the tuning screw in this position. If the signal is less, return the tuning screw to the $\frac{3}{4}$ position. (Final adjustment should be made on a weaker signal by removing the alligator clip on Cord CD-1170 from the center pin of Socket SO-153 of the rack.)

Note

For Radio Receiver BC-624-AM, modified for suppression of impulse noise, the signal heard in the headphones will be considerably less in volume than before modification. Most accurate tuning is obtained if the receiver tuning controls are peaked using only circuit noise or hiss and with the "SIG. GEN." switch on the control unit in the "OFF" position. This "fine" adjustment is to be made after "rough" tuning with the "SIG. GEN." switch in the "ON" position.

b. TUNING REMAINING CHANNELS.

(1) Turn the "OFF ABCD" switch on the control unit to "B" and completely loosen all tuning-control locknuts.

IMPORTANT

Before turning the switch to "B," hold the tuning controls with the fingers and tighten the locknuts just enough to exert a slight pressure on the cam pile-up. While doing this, make certain that the audio output level remains constant. This is accomplished by readjusting the receiver tuning controls.

(2) Follow the same tuning procedure outlined for channel "A" in the paragraphs under 11a, this section.

Note

The tuning instructions for channel "A" apply to channel "B" only if the letter "B" is substituted for "A" wherever the crystal, the channel, and the oscillator plate-coil tuning screw are

Section II

Paragraphs 11-12

AN 16-40SCR522-2

mentioned. This note is equally applicable when tuning channels "C" and "D."

(3) Tune channels "C" and "D" in a like manner; then press channel release push button 426 and tighten the two receiver tuning control locknuts by turning them tightly clockwise with the fingers. If using a tool, do not tighten locknuts excessively. Recheck all channels for satisfactory receiver output. With slight movement of the receiver tuning controls against the detent, maximum signal should be obtained in the rest position. This completes the tuning of the receiver.

c. TUNING ONE CHANNEL ONLY.—If one channel is out of adjustment, it may be tuned without disturbing the other channels.

(1) Turn the "OFF ABCD" switch on the control unit to the channel preceding the channel to be tuned, in the sequence "A," "B," "C," and "D." (For example: If retuning channel "B," turn the switch to "A;" if retuning "A," turn the switch to "D," etc.)

(2) Press channel release push button 426.

(3) Loosen the two receiver tuning-control locknuts

(4) Turn the "OFF ABCD" switch to the desired channel.

(5) Tune the desired channel according to directions in paragraph 11*a*, this section, ignoring reference to channel "A" and substituting the applicable letter.

(6) Press the channel release push button.

(7) Tighten the receiver tuning-control locknuts.

(8) Press the channel release push button to reselect the channel just tuned.

IMPORTANT

Never turn off the radio set with the shifter slides disengaged since this will result in failure to turn on the transmitter and receiver if one particular channel push button is pressed on Radio Control Box BC-602-B or BC-602-C or on the "OFF ABCD" switch on Control Unit BC-1303.

d. RECEIVER "AUDIO" CONTROL ADJUSTMENT.—The exact setting of "AUDIO" control (236) depends upon the volume desired by the pilot. However,

when using Radio Receiver BC-624-A never advance the "AUDIO" control beyond three-quarters or seven-eighths of its maximum rotation. At full volume, excessive distortion occurs with strong signals such as those encountered in formation flying. When using Radio Receiver BC-624-AM, set the "AUDIO" control to the extreme clockwise position. After setting the "AUDIO" control in the receiver, increase or decrease the volume, as desired, by the "AUDIO" control on the jack box.

e. RECEIVER "RELAY" OR "SQUELCH" CONTROL ADJUSTMENT.

Note

The "RELAY" control has been replaced by the "SQUELCH" control in Radio Receiver BC-624-C.

(1) Make this last adjustment on the receiver with the airplane antenna connected, the equipment operating on any tuned channel, and no signal being received.

(2) Rotate "RELAY" or "SQUELCH" control (237) to the extreme clockwise position. Turn it slowly counterclockwise until the noise ceases and continue the counterclockwise rotation for a very small fraction of a turn. Normally make this adjustment when the engines are not running.

(3) If the adjustment has been checked and the pilot still complains of excessive noise in the phones at all times, adjust the "RELAY" or "SQUELCH" control while the engines are running, but omit the small fraction of a turn mentioned in paragraph (2) above.

12. TESTING REMOTE (PRESS-TO-TALK) OPERATION (USING TEST EQUIPMENT IE-36).

a. With Control Unit BC-1303 plugged into socket 417 of the rack and Phantom Antenna A-29 in Socket SO-153, throw the "T-R-REM." switch (107) on the control unit to "REM."

b. With the switch in this position, test the receiver with headphones and buzzer to make certain that it is operating.

c. In position "REM," actuating the "push-to-talk" button or switch should actuate the transmitter as observed by a lighted lamp in the phantom antenna.

SECTION III OPERATION

IMPORTANT

To insure that the storage battery of the airplane will not be excessively drained, operate the radio set for the shortest possible time on the ground prior to take-off.

1. GENERAL.

Note

All operating controls referred to (with the exception of the press-to-transmit switch on the microphone and the "GAIN" screwdriver control on the transmitter) are located on the panel of Radio Control Box BC-602-B.

a. Radio Control Box BC-602-B or BC-602-D provides complete remote control of communications functions. The five red push buttons are the means by which the channels are selected and the power turned on or off. (See fig. 2-6.) These five push buttons are so interconnected that not more than one can be depressed at any given time.

b. The lamps behind the four green jewels indicate which channel is in operation; the lamp behind the white jewel opposite the "T-R-REM." switch glows when the equipment is in the receive condition. All lamps are lighted during the process of channel selection. A dimmer-mask reduces lamp glare and is operated by means of the small lever tab opposite the "OFF" button.

c. When the lever tab located directly above the "T-R-REM." switch is raised, the "T-R-REM." switch can be placed in any one of its three positions. (See fig. 2-6.) When the lever tab is lowered, it blocks the switch from the "REM." position and spring-loads the switch lever so that unless the switch lever is held at "T," it will return to "R."

Note

The "T-R-REM." switch has been disconnected and rendered inoperative in field-modified Radio Control Box BC-602-D and removed entirely from factory-modified Radio Control Box BC-602-D.

2. STARTING AND STOPPING THE EQUIPMENT.

Note

If the equipment has been turned off and standing idle for long periods under extremely humid conditions, it may take several minutes of warm-up before optimum operation is possible.

a. To start the equipment, depress any one of the channel push buttons on the radio control box. If the transmitter and receiver fail to operate when a channel push button is pressed, press another channel push button and then press the push button for the desired channel.

b. To stop the equipment, press the "OFF" push button.

IMPORTANT

Never turn off the equipment with the shifter slides disengaged since this will result in failure to turn on the transmitter and receiver if one particular channel push button on the radio control box is pressed.

3. NORMAL OPERATION.

Note

Line-of-sight communication is normally necessary for satisfactory operation of the radio set. When aircraft are flying in formation, do not keep metal objects (such as belly tank or propeller) between the transmitting and receiving antennas. They may cause low signal strength or garbled reception and make communication difficult or impossible.

a. TRANSMISSION.

Note

The action of all controls of Radio Transmitter BC-625-A is identical with the action of the controls of Radio Transmitter BC-625-AM.

(1) To start the equipment, push push button "A," "B," "C," or "D" on the radio control box, depending on which channel is to be used.

(2) Allow approximately 1 minute for the vacuum tubes to warm up.

(3) Place the "T-R-REM." switch on the radio control box at "T" or actuate the microphone press-to-talk switch of Radio Control Box BC-602-D if in use.

(4) Speak into the microphone. With the airplane in normal flight, communicate with a ground station or another airplane and check the setting of the "GAIN" control.

Note

The "GAIN" control has been replaced by a fixed resistance network in later models of Radio Transmitter BC-625-AM, and no adjustment is necessary.

AN 16-40SCR522-2

(5) If the cockpit noise level is too high, turn the "GAIN" control slightly counterclockwise and have the pilot speak louder during transmission.

b. RECEPTION.

Note

The action of all controls of Radio Receiver BC-624-A is identical with the action of the controls of Radio Receiver BC-624-AM and BC-624-C.

(1) To start the equipment, press push button "A," "B," "C," or "D" on the radio control box.

(2) Place the "T-R-REM." switch at "R." (If Radio Control Box BC-602-D is in use, the equipment is normally in the receive position.)

c. PRESS-TO-TRANSMIT (PRESS-TO-TALK) OPERATION.

(1) To start the equipment press push button "A," "B," "C," or "D" on the radio control box.

(2) Place the "T-R-REM." switch at "REM." The receiver is now in operation.

(3) To transmit, depress the press-to-transmit switch and speak into the microphone.

(4) To receive again, release the press-to-transmit switch.

4. DEFENSE AGAINST RADIO JAMMING.

a. GENERAL.—Jamming is the intentional generation by the enemy of radio signals designed to make friendly signals unreadable and to surprise and confuse the radio operators.

b. PROCEDURE.—If bad interference is received and jamming is suspected, proceed as follows:

(1) Report jamming immediately to the commanding officer.

(2) Change to an alternate frequency and call sign if the primary frequency is badly jammed.

(3) Beware of fake messages slipped into the jamming by the enemy. In case of doubt, authenticate. Do not permit the enemy to distract attention with conversation.

(4) Do not shut down for this is exactly what the enemy wants to happen, and it informs him that the jamming has been effective. Practice, concentration, and persistence will enable an operator to work through jamming which is many times stronger than the desired signal.

SECTION IV

EMERGENCY ADJUSTMENT OR REPAIR

1. REPLACEMENT OF PILOT LAMPS IN RADIO CONTROL BOX BC-602-B AND BC-602-D.

a. Turn the radio set off.

b. To remove a pilot lamp, first remove the two panel mounting screws from the panel of the radio control box. (See fig. 2-6.)

c. Turn the handle of the "T-R-REM." switch counterclockwise until the handle can be removed.

Note

No "T-R-REM." switch will appear on the factory modified Radio Control Box BC-602-D.

d. Remove the panel of the radio control box.

e. Remove the lamp cap. (A lamp-cap remover is supplied with both Test Equipments IE-19-() and IE-36.

Slots are provided in the lamp sleeves to accommodate the lamp-cap remover.) Pull out the lamp. No turning is required.

f. Use the extracting tool also for inserting lamps into the radio control box.

g. If no special tools are available, remove the right-side mounting plate and remove the lamp with a small screw driver.

2. FAILURE OF TRANSMITTER AND RECEIVER TO OPERATE.

If the transmitter and receiver fail to operate when the channel push button is pressed when starting the equipment, press another channel push button and then press the push button for the desired channel.

SECTION V SUPPLEMENTARY DATA

1. MODIFICATION OF RECEIVER AND TRANSMITTER.

a. RADIO TRANSMITTER BC-625-AM.

(1) The "GAIN" control, formerly a screw-driver adjustment, has been replaced by a fixed resistance network in later models of Radio Transmitter BC-625-AM.

(2) The gain of these transmitters is such that proper modulation is secured with carbon microphones such as Microphones T-17 and T-30 when used with Microphone Adapter M-299, and no adjustment of the gain is required.

b. RADIO RECEIVER BC-624-C.

(1) This radio receiver provides higher power output, an electronic squelch circuit in place of the relay, and improved AVC characteristics. The range of the squelch adjustment is restricted to 0 to 20 microvolts and is more reliable than the relay type squelch previously used.

(2) A high audio output tap of approximately 800 ohms is available at terminal No. 5 of the output transformer (reference symbol 200), and a low impedance tap of 80 ohms is available at terminal No. 4. Receivers are shipped from the factory with the high impedance connection. The high impedance connection is recommended for use in fighter aircraft with a single-low-

impedance headset and for multiplace aircraft in which it is desired to parallel other receivers and use high impedance headsets or low impedance headsets with adapters. "Electronic Squelch" and "High Impedance Tap" are stenciled on the top of Radio Receiver BC-624-C near the crystal socket.

2. TYPES OF RADIO JAMMING.

Types of jamming likely to be employed by the enemy are as follows:

a. *Spark* jamming, the familiar type of noise obtained from small electric motors, razors, ignition systems, etc.

b. *Sweep-through* jamming, the result of sweeping a carrier back and forth across a frequency band at a relatively rapid rate (100 to 600 cycles per second). The resulting noise is similar to that of an airplane engine.

c. *Stepped tone* jamming, a monotonous repetition of three to five audio tones which resemble the Scotch bagpipe. The Germans use this regularly.

d. *Noise* jamming, sounding the same as noise which is heard when the gain is turned up on a radio receiver that is not tuned to a signal. It may easily be mistaken for receiver noise.

e. Combinations of any of the above types of jamming.

3. TABLES.

TABLE 5-1. TUBE COMPLEMENT

Reference Symbol	Stock Number	Type Designation		Function	Location of Spares
		JAN	VT		
VT-118	2J832	832	118	Second harmonic amplifier	None
VT-118	2J832	832	118	Radio-frequency power amplifier	None
VT-134	2J12A6	12A6	134	Harmonic amplifier	None
VT-134	2J12A6	12A6	134	Modulator	None
VT-134*	2J12A6	12A6	134	Audio output	None
VT-135†	2J12J5GT	12J5GT	135	Audio-frequency amplifier	None
VT-169	2J12C8	12C8	169	Second detector, AVC, audio-frequency amplifier	None
VT-198-A	2J6G6G	6G6G	198-A	Transmitter oscillator	None
VT-199‡	2J6SS7	6SS7	199	Radio-frequency indicator	None
VT-199	2JSS7	6SS7	199	Speech amplifier	None
VT-202	2J9002	9002	202	Harmonic generator	None
VT-203	2J9003	9003	203	Radio-frequency amplifier	None

*Included in Radio Receiver BC-624-C only.

†Not included in Radio Receiver BC-624-C.

‡Deleted from later models of Radio Transmitter BC-625-A and all models of Radio Transmitter BC-625-AM.

Section V
Paragraph 3

AN 16-40SCR522-2

TABLE 5-1. TUBE COMPLEMENT (Continued)

Reference Symbol	Stock Number	Type Designation		Function	Location of Spares
		JAN	VT		
VT-203	2J9003	9003	203	Mixer	None
VT-203	2J9003	9003	203	Harmonic amplifier	None
VT-207	2J12AH7GT	12AH7GT	207	Oscillator and audio squelch	None
VT-207*	2J12AH7GT	12AH7GT	207	AVC delay, first audio	None
VT-209	2J12SG7	12SG7	209	Intermediate-frequency amplifier	None
VT-209	2J125G7	12SG7	209	Intermediate-frequency amplifier	None
VT-209	2J125G7	12SG7	209	Intermediate-frequency amplifier	None
VT-214§	2J12H6	12H6	214	AVC delay diode, noise limiter diode	None

*Included in Radio Receiver BC-624-C only.

§Included in Radio Receiver BC-624-AM and BC-624-C.

TABLE 5-2. PILOT LAMP COMPLEMENT

Reference Symbol	Type Designation	Stock Number	Location
601-1	W.E. type 2F or G.E. type 12A	2Z5889-1	Radio control box channel "A"
601-2	Same as 601-1		Radio control box channel "B"
601-3	Same as 601-1		Radio control box channel "C"
601-4	Same as 601-1		Radio control box channel "D"
601-5	Same as 601-1		Radio control box, indicates transmit condition

TABLE 5-3. MODIFICATIONS OF MAJOR ASSEMBLIES OF RADIO SET SCR-522-A

Previous Model Number	Latest Model Number	Modification
Radio Transmitter BC-625-A	Radio Transmitter BC-625-A, modified (identified by black line near #4 position of meter switch)	1. R.F. indicator diode removed; filament circuits rewired.
Radio Transmitter BC-625-A	Radio Transmitter BC-625-AM	1. Slow release relay removed.
Radio Receiver BC-624-A	Radio Receiver BC-624-AM	1. Field modified to include tube JAN-12H6, noise suppressor and AVC delay. 2. Factory modified to include tube JAN-12H6, noise suppressor and AVC delay.
	Radio Receiver BC-624-C	1. Tube JAN-12AH7GT added as first audio and AVC delay. 2. Squelch audio tube JAN-12AH7GT now furnishes squelch bias to the grid of the first audio tube JAN-12AH7GT instead of operating the squelch relay. 3. Third audio tube JAN-12A6, replaces tube JAN-12J5. 4. Tube JAN-12C8 changed to AVC and second audio circuit. 5. New output transformer added.
Rack FT-244-A	Unchanged	
Case CS-80-A	Case CS-80-C	1. Base plate to match Mounting FT-488 added.
Radio Control Box BC-602-A	Radio Control Box BC-602-B Radio Control Bob BC-602-D	1. Socket 607 and associated wiring removed. 1. Field modified to render "T-R-REM." switch inoperative by disconnecting the switch. 2. Factory modified to remove "T-R-REM." switch entirely.
Jack Box BC-629-A	Jack Box BC-629-AM	1. Field modified to include audio volume control by T.O. #08-10-105. Factory modified to include audio volume control.
Jack Box BC-630-A	Jack Box BC-629-B	
Jack Box BC-631-A	Unchanged	
Junction Box JB-29-A	Jack Box BC-631-B	1. Audio volume control and limiting resistor added. No longer used in installations.
Dynamotor Unit PE-94-A and Dynamotor Unit PE-94-B	Unchanged	1. Addition of base plate to match Mounting FT-498.
	Dynamotor Unit PE-94-C	
	Dynamotor Unit PE-94-BM or PE-94-CM	1. Addition of improved input and output filters.

AN 16-40SCR522-2

TABLE 5-4. VHF AIRBORNE COMMAND SET, CRYSTAL VS CARRIER FREQUENCIES*

<i>Carrier (megacycles)</i>	<i>Receiver (kilocycles)</i>	<i>Transmitter (kilocycles)</i>	<i>Carrier (megacycles)</i>	<i>Receiver (kilocycles)</i>	<i>Transmitter (kilocycles)</i>
100.08	8007.27	5560.0	109.98	8165.00	6110.0
100.26	8023.64	5570.0	110.16	8180.00	6120.0
100.44	8040.00	5580.0	110.34	8195.00	6130.0
100.62	8056.36	5590.0	110.52	8210.00	6140.0
100.80	8072.73	5600.0	110.70	8225.00	6150.0
100.98	8089.09	5610.0	110.88	8240.00	6160.0
101.16	8105.45	5620.0	111.06	8255.00	6170.0
101.34	8121.82	5630.0	111.24	8270.00	6180.0
101.52	8138.18	5640.0	111.42	8285.00	6190.0
101.70	8154.55	5650.0	111.60	8300.00	6200.0
101.88	8170.91	5660.0	111.78	8315.00	6210.0
102.06	8187.27	5670.0	111.96	8330.00	6220.0
102.24	8203.64	5680.0	112.14	8345.00	6230.0
102.42	8220.00	5690.0	112.32	8360.00	6240.0
102.60	8236.36	5700.0	112.50	8375.00	6250.0
102.78	8252.73	5710.0	112.68	8390.00	6260.0
102.96	8269.09	5720.0	112.86	8405.00	6270.0
103.14	8285.45	5730.0	113.04	8420.00	6280.0
103.32	8301.82	5740.0	113.22	8435.00	6290.0
103.50	8318.18	5750.0	113.40	8450.00	6300.0
103.68	8334.55	5760.0	113.58	8465.00	6310.0
103.86	8350.91	5770.0	113.76	8480.00	6320.0
104.04	8367.27	5780.0	113.94	8495.00	6330.0
104.22	8383.64	5790.0	114.12	8510.00	6340.0
104.40	8400.00	5800.0	114.30	8525.00	6350.0
104.58	8416.36	5810.0	114.48	8540.00	6360.0
104.76	8432.73	5820.0	114.66	8555.00	6370.0
104.94	8449.09	5830.0	114.84	8570.00	6380.0
105.12	8465.45	5840.0	115.02	8585.00	6390.0
105.30	8481.82	5850.0	115.20	8600.00	6400.0
105.48	8498.18	5860.0	115.38	8615.00	6410.0
105.66	8514.55	5870.0	115.56	8630.00	6420.0
105.84	8530.91	5880.0	115.74	8645.00	6430.0
106.02	8547.27	5890.0	115.92	8660.00	6440.0
106.20	8563.64	5900.0			
106.38	8580.00	5910.0			
106.56	8596.36	5920.0	116.10	8007.69	6450.0
106.74	8612.73	5930.0	116.28	8021.54	6460.0
106.92	8629.09	5940.0	116.46	8035.38	6470.0
107.10	8645.45	5950.0	116.64	8049.23	6480.0
107.28	8661.82	5960.0	116.82	8063.08	6490.0
107.46	8678.18	5970.0	117.00	8076.92	6500.0
107.64	8694.55	5980.0	117.18	8090.77	6510.0
107.82	8710.91	5990.0	117.36	8104.62	6520.0
			117.54	8118.46	6530.0
			117.72	8132.31	6540.0
			117.90	8146.15	6550.0
108.00	8000.00	6000.0	118.08	8160.00	6560.0
108.18	8015.00	6010.0	118.26	8173.85	6570.0
108.36	8030.00	6020.0	118.44	8187.69	6580.0
108.54	8045.00	6030.0	118.62	8201.54	6590.0
108.72	8060.00	6040.0	118.80	8215.38	6600.0
108.90	8075.00	6050.0	118.98	8229.23	6610.0
109.08	8090.00	6060.0	119.16	8243.08	6620.0
109.26	8105.00	6070.0	119.34	8256.92	6630.0
109.44	8120.00	6080.0	119.52	8270.77	6640.0
109.62	8135.00	6090.0	119.70	8284.62	6650.0
109.80	8150.00	6100.0			

*This table does not necessarily show all crystals which are available, nor are all those shown available.

Section V
Paragraph 3

AN 16-40SCR522-2

TABLE 5-4 (Continued)

<i>Carrier (megacycles)</i>	<i>Receiver (kilocycles)</i>	<i>Transmitter (kilocycles)</i>	<i>Carrier (megacycles)</i>	<i>Receiver (kilocycles)</i>	<i>Transmitter (kilocycles)</i>
119.88	8298.46	6660.0	129.96	8425.71	7220.0
120.06	8312.31	6670.0	130.14	8438.57	7230.0
120.24	8326.15	6680.0	130.32	8451.43	7240.0
120.42	8340.00	6690.0	130.50	8464.29	7250.0
120.60	8353.85	6700.0	130.68	8477.14	7260.0
120.78	8367.69	6710.0	130.86	8490.00	7270.0
120.96	8381.54	6720.0	131.04	8502.86	7280.0
121.14	8395.38	6730.0	131.22	8515.71	7290.0
121.32	8409.23	6740.0	131.40	8528.57	7300.0
121.50	8423.08	6750.0	131.58	8541.43	7310.0
121.68	8436.92	6760.0	131.76	8554.29	7320.0
121.86	8450.77	6770.0	131.94	8567.14	7330.0
122.04	8464.62	6780.0			
122.22	8478.46	6790.0			
122.40	8492.31	6800.0	132.12	8008.00	7340.0
122.58	8506.15	6810.0	132.30	8020.00	7350.0
122.76	8520.00	6820.0	132.48	8032.00	7360.0
122.94	8533.85	6830.0	132.66	8044.00	7370.0
123.12	8547.69	6840.0	132.84	8056.00	7380.0
123.30	8561.54	6850.0	133.02	8068.00	7390.0
123.48	8575.38	6860.0	133.20	8080.00	7400.0
123.66	8589.23	6870.0	133.38	8092.00	7410.0
123.84	8603.08	6880.0	133.56	8104.00	7420.0
			133.74	8116.00	7430.0
			133.92	8128.00	7440.0
124.02	8001.43	6890.0	134.10	8140.00	7450.0
124.20	8014.29	6900.0	134.28	8152.00	7460.0
124.38	8027.14	6910.0	134.46	8164.00	7470.0
124.56	8040.00	6920.0	134.64	8176.00	7480.0
124.74	8052.86	6930.0	134.82	8188.00	7490.0
124.92	8065.71	6940.0	135.00	8200.00	7500.0
125.10	8078.57	6950.0	135.18	8212.00	7510.0
125.28	8091.43	6960.0	135.36	8224.00	7520.0
125.46	8104.29	6970.0	135.54	8236.00	7530.0
125.64	8117.14	6980.0	135.72	8248.00	7540.0
125.82	8130.00	6990.0	135.90	8260.00	7550.0
126.00	8142.86	7000.0	136.08	8272.00	7560.0
126.18	8155.71	7010.0	136.26	8284.00	7570.0
126.36	8168.57	7020.0	136.44	8296.00	7580.0
126.54	8181.43	7030.0	136.62	8308.00	7590.0
126.72	8194.29	7040.0	136.80	8320.00	7600.0
126.90	8207.14	7050.0	136.98	8332.00	7610.0
127.08	8220.00	7060.0	137.16	8344.00	7620.0
127.26	8232.86	7070.0	137.34	8356.00	7630.0
127.44	8245.71	7080.0	137.52	8368.00	7640.0
127.62	8258.57	7090.0	137.70	8380.00	7650.0
127.80	8271.43	7100.0	137.88	8392.00	7660.0
127.98	8284.29	7110.0	138.06	8404.00	7670.0
128.16	8297.14	7120.0	138.24	8416.00	7680.0
128.34	8310.00	7130.0	138.42	8428.00	7690.0
128.52	8322.86	7140.0	138.60	8440.00	7700.0
128.70	8335.71	7150.0	138.78	8452.00	7710.0
128.88	8348.57	7160.0	138.96	8464.00	7720.0
129.06	8361.43	7170.0	139.14	8476.00	7730.0
129.24	8374.29	7180.0	139.32	8488.00	7740.0
129.42	8387.14	7190.0	139.50	8500.00	7750.0
129.60	8400.00	7200.0	139.68	8512.00	7760.0
129.78	8412.86	7210.0	139.86	8524.00	7770.0

*This table does not necessarily show all crystals which are available, nor are all those shown available.

AN 16-40SCR522-2

TABLE 5-4 (Continued)

<i>Carrier (megacycles)</i>	<i>Receiver (kilocycles)</i>	<i>Transmitter (kilocycles)</i>	<i>Carrier (megacycles)</i>	<i>Receiver (kilocycles)</i>	<i>Transmitter (kilocycles)</i>
140.04	8002.50	7780.0	148.14	8008.24	8230.0
140.22	8013.75	7790.0	148.32	8018.82	8240.0
140.40	8025.00	7800.0	148.50	8029.41	8250.0
140.58	8036.25	7810.0	148.68	8040.00	8260.0
140.76	8047.50	7820.0	148.86	8050.59	8270.0
140.94	8058.75	7830.0	149.04	8061.18	8280.0
141.12	8070.00	7840.0	149.22	8071.76	8290.0
141.30	8081.25	7850.0	149.40	8082.35	8300.0
141.48	8092.50	7860.0	149.58	8092.94	8310.0
141.66	8103.75	7870.0	149.76	8103.53	8320.0
141.84	8115.00	7880.0	149.94	8114.12	8330.0
142.02	8126.25	7890.0	150.12	8124.71	8340.0
142.20	8137.50	7900.0	150.30	8135.29	8350.0
142.38	8148.75	7910.0	150.48	8145.88	8360.0
142.56	8160.00	7920.0	150.66	8156.47	8370.0
142.74	8171.25	7930.0	150.84	8167.06	8380.0
142.92	8182.50	7940.0	151.02	8177.65	8390.0
143.10	8193.75	7950.0	151.20	8188.24	8400.0
143.28	8205.00	7960.0	151.38	8198.82	8410.0
143.46	8216.25	7970.0	151.56	8209.41	8420.0
143.64	8227.50	7980.0	151.74	8220.00	8430.0
143.82	8238.75	7990.0	151.92	8230.59	8440.0
144.00	8250.00	8000.0	152.10	8241.18	8450.0
144.18	8261.25	8010.0	152.28	8251.76	8460.0
144.36	8272.50	8020.0	152.46	8262.35	8470.0
144.54	8283.75	8030.0	152.64	8272.94	8480.0
144.72	8295.00	8040.0	152.82	8283.53	8490.0
144.90	8306.25	8050.0	153.00	8294.12	8500.0
145.08	8317.50	8060.0	153.18	8304.71	8510.0
145.26	8328.75	8070.0	153.36	8315.29	8520.0
145.44	8340.00	8080.0	153.54	8325.88	8530.0
145.62	8351.25	8090.0	153.72	8336.47	8540.0
145.80	8362.50	8100.0	153.90	8347.06	8550.0
145.98	8373.75	8110.0	154.08	8357.65	8560.0
146.16	8385.00	8120.0	154.26	8368.24	8570.0
146.34	8396.25	8130.0	154.44	8378.82	8580.0
146.52	8407.50	8140.0	154.62	8389.41	8590.0
146.70	8418.75	8150.0	154.80	8400.00	8600.0
146.88	8430.00	8160.0	154.98	8410.59	8610.0
147.06	8441.25	8170.0	155.16	8421.18	8620.0
147.24	8452.50	8180.0	155.34	8431.76	8630.0
147.42	8463.75	8190.0	155.52	8442.35	8640.0
147.60	8475.00	8200.0	155.70	8452.94	8650.0
147.78	8486.25	8210.0	155.88	8463.53	8660.0
147.96	8497.50	8220.0			

*This table does not necessarily show all crystals which are available, nor are all those shown available.

SC
3585
A