

3431-FILE

TM 11-344

WAR DEPARTMENT TECHNICAL MANUAL

Classification cancelled by authority of the Comdt,
The Signal School, FM, N.J. (25 Nov 52).
By order of the Director, ED, TSS (AR 380-5)

CONVERTER

M-222

D 7

WAR DEPARTMENT • APRIL 1946

WAR DEPARTMENT TECHNICAL MANUAL

TM 11-344

*This manual supersedes TM 11-344, 8 January 1943, including C 1, 23 March 1943;
C 2, 11 December 1943; and C 3, 4 January 1945*

CONVERTER

M-222



WAR DEPARTMENT •

APRIL 1946

United States Government Printing Office

Washington : 1946

CONTENTS

PART ONE. INTRODUCTION.

<i>Section</i>		<i>Paragraph</i>	<i>Page</i>
<i>I.</i>	Description of Converter M-222.		
	Application	1	1
	Technical characteristics.....	2	1
	Description	3	1
	List of Components.....	4	4
	Packaging data.....	5	5
<i>II.</i>	Installation of Converter M-222.		
	Unpacking, uncrating, and checking.....	6	5
	Installation of batteries.....	7	7
	Connection of Converter M-222.....	8	8
	Removal from service.....	9	8

PART TWO. OPERATING INSTRUCTIONS.

<i>Section III.</i>	Operation.		
	Operation of Converter M-222.....	10	9

PART THREE. MAINTENANCE INSTRUCTIONS

<i>Section IV.</i>	Preventive maintenance techniques.		
	Meaning of preventive maintenance.....	11	10
	Description of preventive maintenance techniques	12	10
<i>V.</i>	Itemized preventive maintenance.		
	Introduction	13	11
	Common materials needed.....	14	12
	Exterior of Converter M-222.....	15	12
	Interior of Converter M-222.....	16	12
	Preventive maintenance check list.....	17	13
<i>VI.</i>	Lubrication.		
<i>VII.</i>	Moistureproofing and fungiproofing.		
	General	18	14
	Reducing failures.....	19	14
	Treating Converter M-222.....	20	14
	Treating equipment after repairs.....	21	17

PART FOUR. AUXILIARY EQUIPMENT.

(Not used.)

PART FIVE. REPAIR INSTRUCTIONS.

<i>Section VIII.</i>	<i>Theory of equipment.</i>		
	Input circuit.....	22	19
	Output circuit.....	23	21
<i>IX.</i>	Trouble shooting.		
	General	24	22
	Circuit tests.....	25	22
	Trouble-shooting chart.....	26	24

WAR DEPARTMENT

Washington 25, D. C., 1 April 1946

TM II-344, Converter M-222, is published for the information and guidance of all concerned.

[AG 300.7 (7 Dec. 45)]

BY ORDER OF THE SECRETARY OF WAR:

OFFICIAL:	DWIGHT D. EISENHOWER
EDWARD F. WITSELL	<i>Chief of Staff</i>
<i>Major General</i>	
<i>The Adjutant General</i>	

DISTRIBUTION:

AAF (5); AGF (5); ASF (2); T (5); Dept (2); Base Comd (2); Arm & Sv Bd (1); S Div ASF (1); Tech Sv (2); SvC (2); ATSC (2); Dep II (2); Lab II (2); 4th & 5th Ech Maint Shops II (2); Three (3) copies to each of the following T/O & E's: 11-107; 11-127; 11-587; 11-592; 11-597; Two (2) copies to each of the following T/O & E's: 6-10-1S; 6-20-1; 6-50-1; 11-7; 11-7-S; 11-57; 11-97; 11-158T; 11-537.

Refer to FM 21-6 for explanation of distribution formula.

	<i>Paragraph</i>	<i>Page</i>
X. Repairs.		
Replacement of parts.....	27	27
Burnishing vibrator contacts.....	28	27
Painting and refinishing.....	29	28
Unsatisfactory Equipment Report.....	30	28
APPENDIX I. REFERENCES.....		31
II. MAINTENANCE PARTS.....		33

DESTRUCTION NOTICE

WHY — To prevent the enemy from using or salvaging this equipment for his benefit.

WHEN — When ordered by your commander.

HOW — 1. Smash—Use sledges, axes, handaxes, pickaxes, hammers, crowbars, heavy tools.
 2. Cut—Use axes, handaxes, machetes.
 3. Burn—Use gasoline, kerosene, oil, flame throwers, incendiary grenades.
 4. Explosives—Use firearms, grenades, TNT.
 5. Disposal—Bury in slit trenches, fox holes, other holes. Throw in streams. Scatter.

USE ANYTHING IMMEDIATELY AVAILABLE FOR DESTRUCTION OF THIS EQUIPMENT

WHAT — 1. Smash—Vibrator, transformer, capacitors, switch, box.
 2. Cut—All wires.
 3. Burn—Instruction books, cut wires, technical manuals, paper.
 4. Bury or scatter—Any or all of the above parts after smashing.

DESTROY EVERYTHING

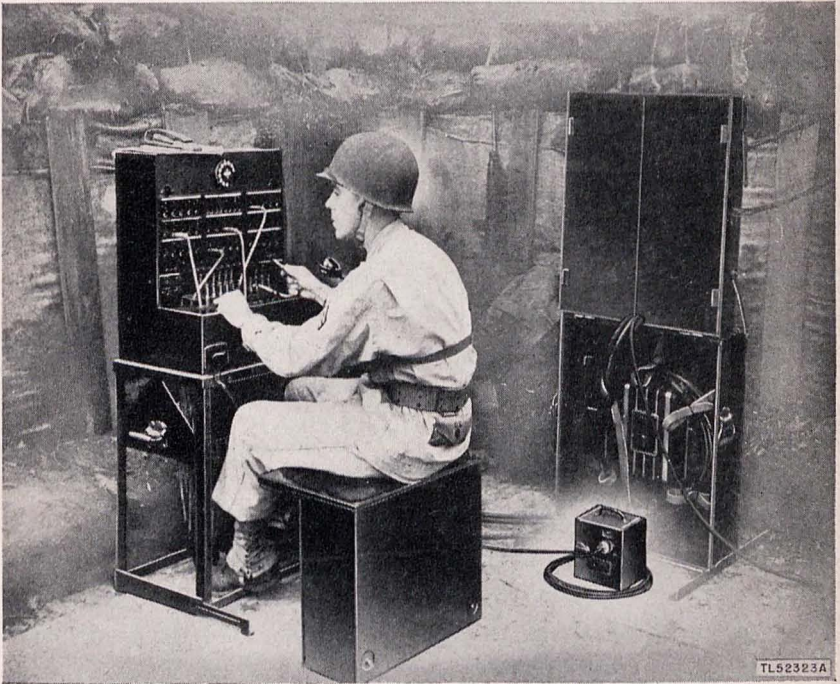

Figure 1. Converter M-222 in use with Telephone Central Office Set TC-4.

This manual supersedes TM 11-344, 8 January 1943, including C 1, 23 March 1943; C 2, 11 December 1943; and C 3, 4 January 1945.

PART ONE

INTRODUCTION

Section I. DESCRIPTION OF CONVERTER M-222

1. Application

Converter M-222 is designed to supply emergency power ringing current for telephone switchboards such as Switchboards BD-91-() and BD-96, when power from a 110-volt, 60-cycle source is not available or when the standard 110-volt power ringing equipment fails in service. Converter M-222 is a component of Telephone Central Office Sets TC-4 and TC-12. Figure 1 shows Converter M-222 in use with Telephone Central Office Set TC-4.

2. Technical Characteristics

a. POWER SOURCE. Converter M-222 uses two 1½-volt Batteries BA-23, connected in series, as a source of power. Battery life is approximately 8 to 10 hours under continuous operation.

b. OUTPUT VOLTAGE AND FREQUENCY. The output of Converter M-222 is 100 volts alternating current open circuit, or 50 volts with a 5-watt load. The peak voltage will not exceed 250 volts. The frequency of the output voltage is 24 cycles \pm 4 cycles.

3. Description

Converter M-222 consists essentially of the following assemblies:

a. Box. Converter M-222 is housed in a rectangular steel box with two removable sides. (See fig. 2.) On the front panel are mounted an output receptacle, a nameplate, the lower section of one catch fastener, and Switch SW-105. The switch is mounted in a recess in the panel. The ON and OFF positions of the switch are marked on the panel.

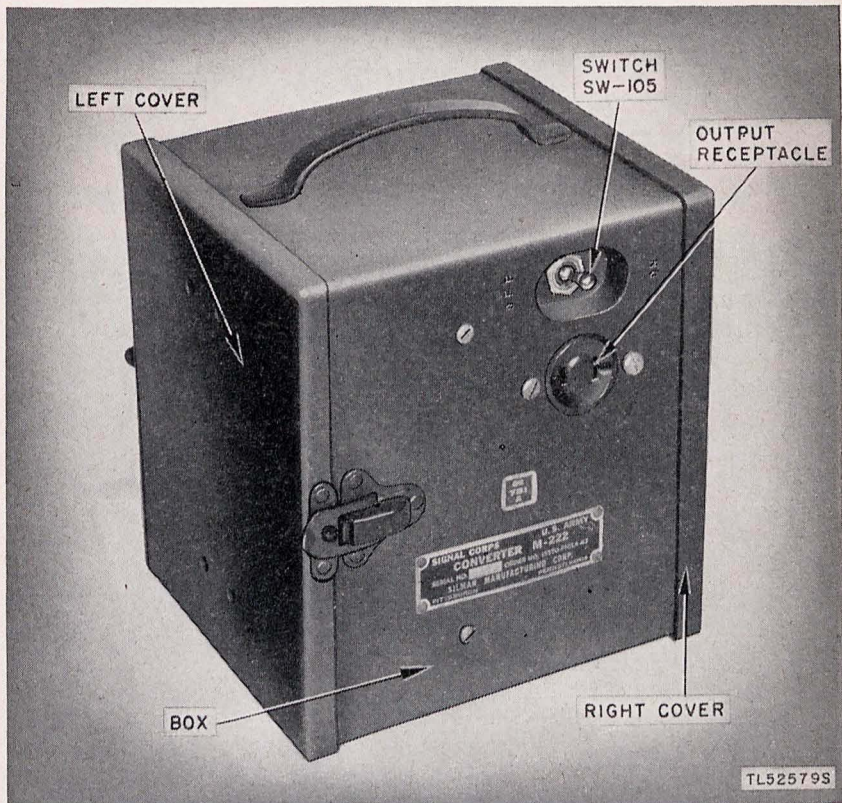

Figure 2. Converter M-222—outside view.

b. MOUNTING SHELF ASSEMBLY. On top of the shallow steel mounting shelf are mounted one transformer, one 0.25-mf Capacitor CA-385, one 1-mf Capacitor CA-234, and one vibrator. (See figs. 3 and 4.) The vibrator is encased in a metal box and is held in place by two steel clips which are welded to the cover. The vibrator plugs into a six-prong socket. A fiber insulator is mounted on the under side of the shelf assembly, directly under Capacitor CA-234. The mounting shelf assembly is fastened to the box by four No. 6-32 flat-top, binding head screws.

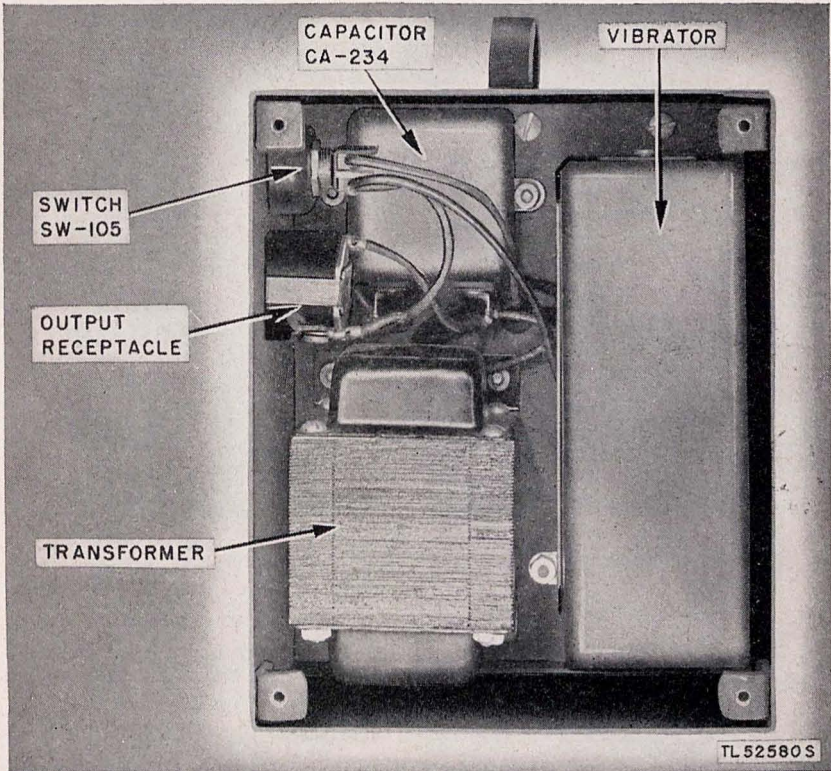

Figure 3. Converter M-222—right cover removed.

c. RIGHT COVER. The cover, to the right of the nameplate when the operator is facing the converter, is fastened to the box by four No. 8-32 roundhead screws, which fasten into four tapped angle brackets welded in the corners of the box. Two steel clips are welded to the back of this cover to hold the vibrator securely when the cover is in place. The circuit label is attached to the inside of the right cover.

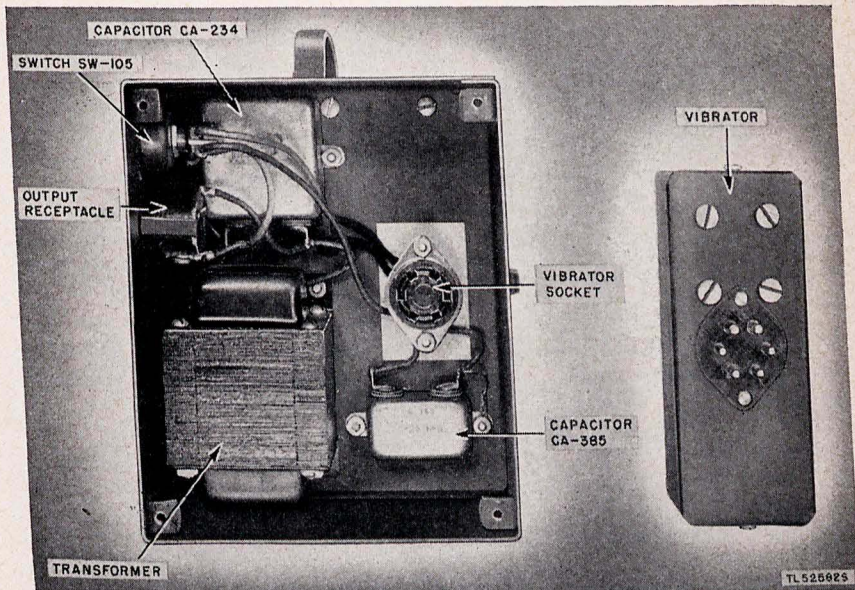

Figure 4. Converter M-222—right cover and vibrator unit removed.

d. LEFT COVER. Two spring clips are mounted on the inside of the left cover to hold the batteries in place. The upper section of the two catch fasteners, used to fasten the cover to the box, are mounted on the sides of the left cover.

4. List of Components

a. EQUIPMENT SUPPLIED.

Quantity	Name of component	Dimensions (in.)			Weight (lb)
		Height	Width	Depth	
1	Converter M-222	8¼	6¾	6⅝	11
2	TM 11-344

b. EQUIPMENT REQUIRED BUT NOT SUPPLIED.

Quantity	Name of component	Dimensions (in.)			Weight (lb)
		Height	Width	Depth	
2	Batteries BA-23. . . .	6½	25⅝ (diam)	2.7

Note. This list is for general information only. See appropriate publications for information pertaining to requisition of spare parts.

5. Packaging Data

a. When packaged for oversea shipment and not associated with other equipment, four Converters M-222, individually wrapped in water-proof fiberboard containers, are crated in a wooden box 20 inches long, 17¾ inches wide, and 11¾ inches deep. Shipping weight is approximately 70 pounds. The wooden box containing the four converters occupies approximately 2.4 cubic feet.

b. When Converter M-222 is furnished as a component of Telephone Central Office Set TC-4 or TC-12, it is packaged with other components of the central office set as explained in TM 11-332 and TM 11-336, respectively.

Section II. INSTALLATION OF CONVERTER M-222

6. Unpacking, Uncrating, and Checking

a. GENERAL. Take care when unpacking or handling the equipment. It may be damaged easily when not protected by the packing case. When unpacking the converter follow the steps outlined below:

(1) Place the packing case in a convenient location where it can be opened easily.

(2) Cut the steel straps.

(3) Remove the nails with a nail puller and remove the top of the packing case. *Prying the top off may result in damage to the equipment.*

(4) Carefully remove the four Converters M-222 from the wooden packing case.

b. REMOVAL OF CONVERTER FROM FIBERBOARD BOX. (1) Open the outer fiberboard box and remove the wrapped inner fiberboard box which contains the converter.

(2) Remove the moistureproof wrapping and open the inner fiberboard box.

(3) Remove the converter from the inner fiberboard box.

(4) Open the lid of the converter and remove the bags of silica gel from the battery compartment.

(5) Check the converter to make sure no damage has resulted during shipment.

Caution: If the converter has received moistureproofing and fungi-proofing treatment, *do not remove* any of the protective coating.

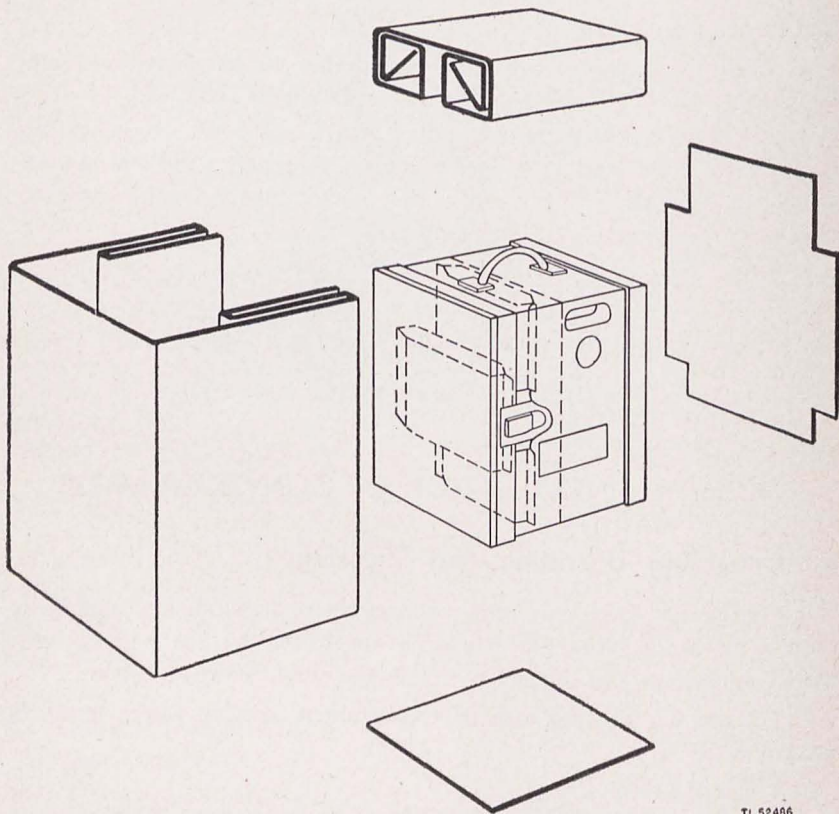

TL 52486

Figure 5. Interior of inner packing-box containing converter.

7. Installation of Batteries

Two Batteries BA-23, connected in series, are required for operation of Converter M-222. To install the batteries proceed as outlined below:

a. Unfasten the two catch fasteners and remove the left cover from the box.

b. Remove the short lead (battery connector) from the spring clips inside the cover.

c. Connect the two Batteries BA-23 in series using the battery connector.

d. Connect the green wire which is grounded to the case of the converter to the vacant positive terminal of the two batteries, and connect the red wire to the vacant negative terminal.

e. Place the batteries in the battery compartment with the terminals facing the fiber insulator. Push the batteries toward the bottom of the compartment until the terminals fit below the phenolic strip which is mounted above the insulator.

f. Replace the cover and fasten the catch fasteners. The spring clips mounted inside the cover will hold the batteries firmly in place.

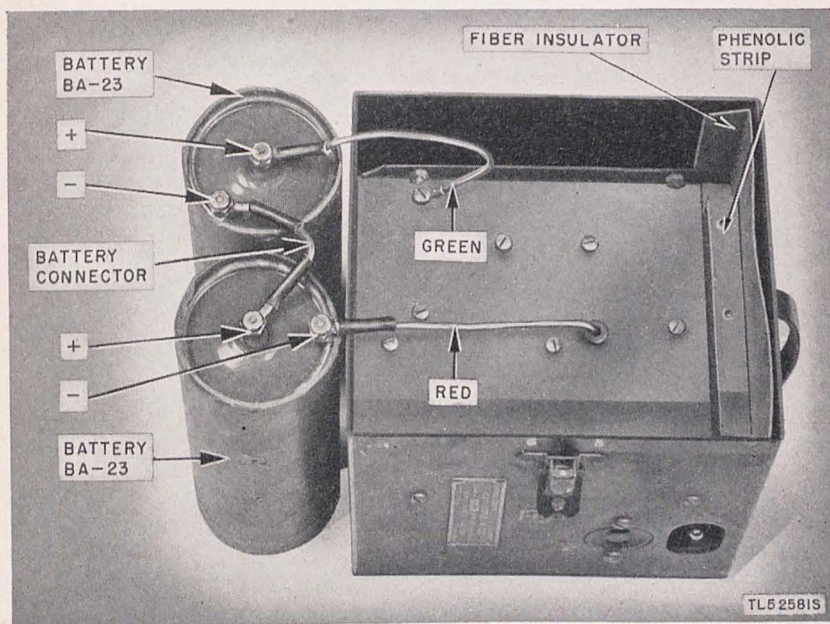

Figure 6. Converter M-222—installation of batteries.

8. Connection of Converter M-222

To connect Converter M-222 for use, plug the power ringing cord from the switchboard into the receptacle located on the front of the converter.

9. Removal from Service

- a.* Operate Switch SW-105 (fig. 2) to the OFF position.
- b.* Remove the plug of the connecting cord from the receptacle.
- c.* If the converter is not to be used or is to be stored for some time, remove the batteries from the battery compartment.

PART TWO

OPERATING INSTRUCTIONS

Note. For information on destroying the equipment to prevent enemy use, refer to the destruction notice at the front of the manual.

Section III. OPERATION

10. Operation of Converter M-222

a. To start the converter, throw Switch SW-105 to the ON position. Feel the box to determine whether or not the vibrator is operating. If the vibrator is in operation, there will be a noticeable vibration of the box.

b. To stop the converter, throw Switch SW-105 to the OFF position.

Caution: When converter is not in use, always throw Switch SW-105 to the OFF position to prevent batteries from being discharged.

PART THREE

MAINTENANCE INSTRUCTIONS

Section IV. PREVENTIVE MAINTENANCE TECHNIQUES

11. Meaning of Preventive Maintenance

Preventive maintenance is a systematic series of operations performed at regular intervals on equipment, when turned off, to eliminate major break-downs and unwanted interruptions in service, and to keep the equipment operating at top efficiency. To understand what is meant by preventive maintenance, it is necessary to distinguish preventive maintenance from trouble shooting and repair. The prime function of preventive maintenance is to *prevent* break-downs and, therefore, the need for repair. The prime function of trouble shooting and repair is to locate and correct *existing* defects. The importance of preventive maintenance cannot be overemphasized. A system of communications depends upon the readiness and operating efficiency of each item of equipment when it is needed. Keep the equipment in first-rate operating condition at all times.

12. Description of Preventive Maintenance Techniques

a. GENERAL. Although Converter M-222 has a small number of component parts, routine preventive maintenance is required. Because hit-or-miss maintenance techniques cannot be applied, definite and specific instructions are needed. This section of the manual contains these specific instructions and serves as a guide for personnel assigned to perform the six basic maintenance operations: Feel, Inspect, Tighten, Clean, Adjust, and Lubricate. Throughout this manual the following lettering system for the six operations will be:

F—Feel*
I—Inspect
T—Tighten
C—Clean
A—Adjust*
L—Lubricate*

* The Feel, Adjust, and Lubricate operations are inapplicable to Converter M-222.

The second operation (Inspect) shows when the other two are needed. Selection of operations is based on a knowledge of field needs. For example, dust encountered on dirt roads during cross-country travel filters into the equipment no matter how much care is taken to prevent

it. Rapid changes in weather (such as heavy rain followed by blistering heat), excessive dampness, snow, and ice tend to cause corrosion of exposed surfaces and parts. Without frequent inspections and the necessary tightening and cleaning operations, equipment becomes undependable and may break down when it is most needed.

b. INSPECT. Inspection is the most important operation in the preventive maintenance program. A careless observer will overlook the evidences of minor trouble. Although these defects may not interfere with the performance of the equipment, valuable time and effort can be saved if they are corrected *before* they lead to major break-downs. Make every effort to become thoroughly familiar with the indications of normal functioning, to recognize the signs of a defective set. Inspect for the following conditions.

(1) Overheating, as indicated by discoloration, blistering, or bulging of the parts or surface of the container; leakage of insulating compounds; oxidation of metal contact surfaces.

(2) Placement, by observing that all leads and cabling are in their original positions.

(3) Cleanliness, by carefully examining all recesses in the unit for accumulation of dust, excessive moisture, etc., especially between connecting terminals. Parts, connections, and joints should be free of dust, corrosion, and other foreign matter. In tropical and high-humidity locations, look for fungus growth and mildew.

(4) Tightness, by testing any connection or mounting which appears to be loose.

c. TIGHTEN AND CLEAN. These operations are self-explanatory. The procedures to be followed in performing them are given wherever necessary throughout part three.

Caution: Do not tighten screws, bolts, and nuts carelessly. Fittings tightened beyond the pressure for which they are designed will be damaged or broken. Whenever a loose connection is tightened, moistureproof and fungiproof it again by applying the varnish with a small brush. (See sec. VII for details of moistureproofing and fungiproofing.)

Section V. ITEMIZED PREVENTIVE MAINTENANCE

13. Introduction

The general technique involved and the application of the FITCAL operations in performing preventive maintenance on individual parts are discussed in this section. Perform all work with the power turned off. After preventive maintenance has been performed, operate the equipment and check it for satisfactory performance.

14. Common Materials Needed

The following materials will be needed in performing preventive maintenance:

- Common hand tools.
- Clean, lint-free cloths.
- #0000 sandpaper.
- Small brushes.
- Dry-cleaning solvent (SD).

Note. Gasoline will not be used as a cleaning fluid for any purpose. Solvent, dry cleaning, is available as a cleaning fluid through established supply channels. Oil, fuel, Diesel, may be used for cleaning purposes when dry-cleaning solvent (SD) is not at hand. Carbon tetrachloride will be used as a cleaning fluid only in the following cases: where inflammable solvents cannot be used because of the fire hazard, and for cleaning electrical contacts including relays, plugs, commutators, etc.

15. Exterior of Converter M-222

a. INSPECT (I). (1) Inspect the box for broken or damaged places, chipped paint, dirt, dust, rust, corrosion, and loose or missing screws.

(2) Inspect the toggle switch for looseness of mounting.

b. TIGHTEN (T). (1) Tighten all loose screws with a screw driver of the proper size.

(2) If the toggle switch is loose, remove the right cover of Converter M-222, and tighten the hexagonal nuts which mount the switch to the box. Tighten the exterior hexagonal nut with a socket wrench and the interior nut with an open-end, flat wrench of the proper size.

c. CLEAN (C). Using a soft, clean, lint-free cloth, wipe off all dirt and dust from the box and exterior of the covers. If necessary, use dry-cleaning solvent to remove grease and oil.

16. Interior of Converter M-222

Unfasten the two catch fasteners and take off the left cover of Converter M-222. Remove the four corner screws from the right cover and take off the cover. Remove the vibrator by pulling it away from the mounting socket.

a. INSPECT (I). (1) Inspect all chassis wiring for frayed or defective insulation and cracks or evidence of dry rot. Check to see that all connections are tight.

(2) Carefully examine all parts for loose or missing mounting screws and nuts. Do not remove the cover of the vibrator.

(3) Examine all parts for dirt, dust, corrosion, and fungus.

(4) Check the interior of the battery compartment for loose or missing screws. Examine the battery leads for signs of damaged insulation. Carefully inspect the terminals for dirt or corrosion.

(5) Check the batteries for cracked or loose sealing compound and electrolyte leakage.

b. TIGHTEN (T). (1) Securely tighten all screws and nuts found to be loose, but do not force. The mounting screws for the capacitors, vibrator socket, transformer, and green (positive) battery lead are accessible from the battery compartment.

(2) If necessary resolder loose wiring connections.

c. CLEAN (C). (1) Clean the interior of the converter with a clean, lint-free cloth. Use a small bristle brush on the parts not accessible for cleaning with the cloth. If necessary, use dry-cleaning solvent (SD) to remove oil, grease, or wax compounds. Do not attempt to clean the interior of the vibrator unit.

(2) Clean the terminal lugs of the two battery connectors with a brush moistened in dry-cleaning solvent (SD). Remove corrosion with #0000 sandpaper, then wipe the terminals with a clean cloth.

17. Preventive Maintenance Check List

The following check list is a summary of the preventive maintenance operations to be performed on Converter M-222. The time intervals shown on the check list may be reduced at any time by the local commander. For best performance of the equipment, perform operations at least as frequently as called for in the check list.

Item No.	Operations	Description of item	When performed	
			Weekly	Monthly
1 ..	ITC	Exterior of Converter M-222.	X
2 ..	I	Batteries.	X
3 ..	ITC	Interior of Converter M-222.	X

Note. X indicates when operations are to be performed.

F*	I	T	C	A*	L*
Feel	Inspect	Tighten	Clean	Adjust	Lubricate

Section VI. LUBRICATION

Note. Lubrication of Converter M-222 is not required.

*The Feel, Adjust, and Lubricate operations are inapplicable to Converter M-222.

Section VII. MOISTUREPROOFING AND FUNGIPROOFING

18. General

a. When equipment is operated in highly humid climates, excessive failure of parts and decreased operating efficiency are usually caused by the accumulated effects of moisture, rather than by inferior parts. Rapid temperature changes accompanied by fog, rain, dew, or high humidity promote such failures.

b. The effects of moisture on resistors, capacitors, coils, chokes, transformer windings, terminal boards, and insulating strips can be recognized in the form of corrosion, low insulation resistance, flash-overs, and crosstalk. Moisture also accelerates fungus growth which increases these effects.

19. Reducing Failures

a. A moistureproofing and fungiproofing treatment has been devised which, if properly applied, provides a reasonable degree of protection. The treatment consists of applying a film of moisture- and fungi-resistant varnish to all susceptible parts of the equipment. This film provides a nonwetting surface. Equipments which have been treated have been marked with the letters MFP and the date of treatment. Equipments not marked should be examined, and if treatment has not been applied, the equipment should be returned to third or higher echelon maintenance units for treatment.

b. TB SIG 13 and Changes 1 and 2 contain a detailed description of this treatment.

c. Retreatment may be required after a period of use. Need for this retreatment is indicated by excessive failures or by the effects listed in paragraph 18*b*.

20. Treating Converter M-222

a. PREPARATION. Make all repairs and adjustments necessary for proper operation of the equipment.

b. DISASSEMBLY. (1) Release catches on battery compartment cover and remove cover. Remove batteries if installed.

(2) Remove cover of wiring compartment by removing the four screws which hold it in place.

(3) Remove vibrator unit by pulling it from plug receptacle.

(4) Remove cover from vibrator unit by removing the two screws at ends of vibrator unit case.

c. CLEANING. Clean all dirt, dust, rust, and fungus from the equipment to be processed. Clean all oil and grease from the surfaces to be varnished.

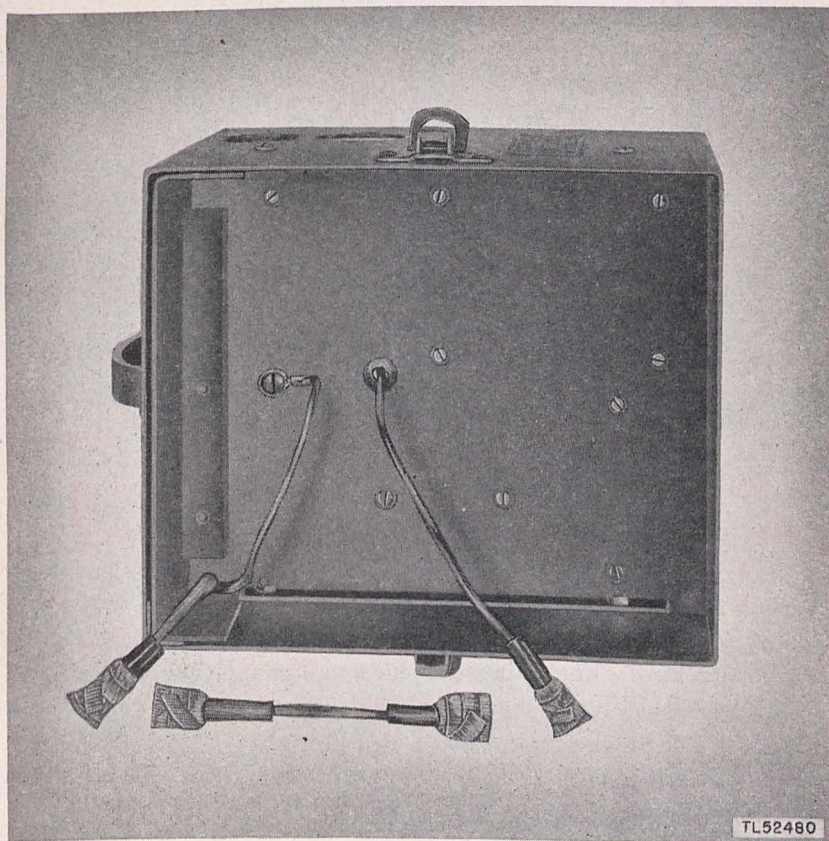

Figure 7. Converter M-222—battery compartment, battery connecting wires masked.

d. MASKING. (1) Mask bare ends of battery connecting wires. (See fig. 7.)

(2) Mask vibrator unit plug receptacle. (See fig. 8.)

(3) Mask vibrator unit contact spring. (See fig. 8.)

(4) Mask the screw holes in the cover of the vibrator unit. (See fig. 8.)

e. DRYING. Place equipment in an oven or under heat lamps and dry for 2 to 3 hours at 140° F.

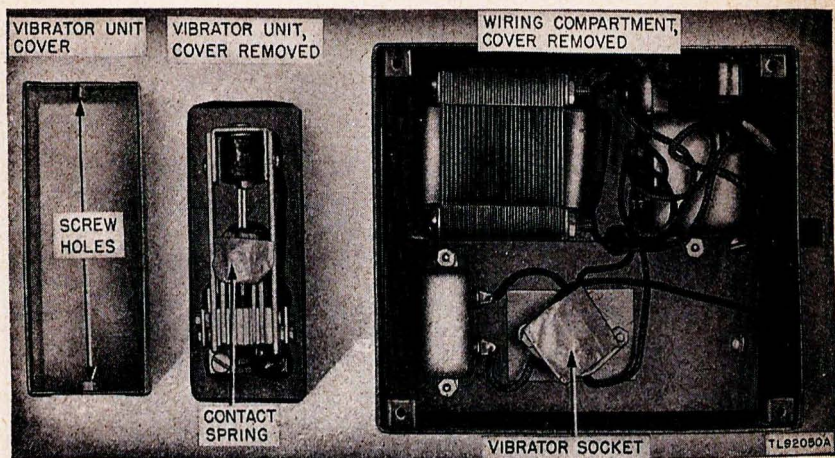

Figure 8. Converter M-222 inside of chassis, vibrator unit removed, vibrator unit plug receptacle and contact spring masked.

f. VARNISHING. (1) Spray three coats of moistureproofing and fungi-proofing varnish (lacquer, fungus-resistant, Signal Corps stock No. 6G1005.3, or equal) to parts listed in (3) through (6) below. Allow each coat to air-dry for 15 or 20 minutes before applying the next coat.

(2) Apply varnish immediately after the equipment is dried. If varnish is not applied immediately, moisture condenses on the equipment. Varnish applied over the moisture peels off readily after the varnish has dried.

(3) Battery compartment. (See fig. 7.)

(4) Battery connecting wires. (See fig. 7.)

(5) Transformer, vibrator unit, and wiring compartment. (See fig. 8.)

(6) Inside of vibrator unit case and vibrator unit cover. (See fig. 8.)

g. REASSEMBLY. (1) Remove all masking tape, being careful not to peel varnish from near-by areas.

(2) If necessary to remove varnish from the vibrator contacts, burnish the contacts with a contact burnishing tool.

(3) Reassemble the converter and test for proper operation of circuit elements.

h. MARKING. Mark the letters MFP and the date of treatment near the nameplate on the converter.

Example: MFP—15 Dec 45.

21. Treating Equipment After Repairs

If the coating of protective varnish has been punctured or broken during repair and if complete treatment is not needed to reseal the equipment, brush-coat the affected part. Be sure the break is completely sealed.

PART FOUR
AUXILIARY EQUIPMENT

(Not used.)

PART FIVE

REPAIR INSTRUCTIONS

Note. Failure or unsatisfactory performance of equipment used by Army Ground Forces and Army Service Forces will be reported on WD AGO Form 468 (Unsatisfactory Equipment Report); by Army Air Forces, on Army Air Forces Form 54 (Unsatisfactory Report). If either form is not available, prepare letter containing the data elicited by the sample form shown in figure 16 or 17 without reproducing copies of the form.

Section VIII. THEORY OF EQUIPMENT

22. Input Circuit

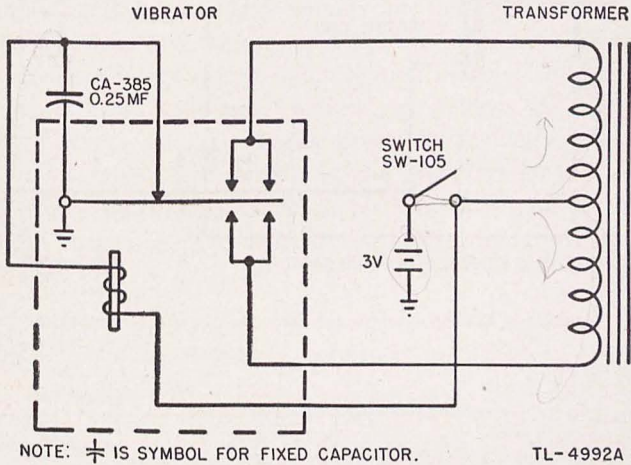

Figure 9. Converter M-222—functional diagram of input circuit.

The input circuit (fig. 9) consists of the vibrator, the tapped transformer primary, Switch SW-105, two Batteries BA-23, and Capacitor CA-385. The input current flows from the batteries through Switch SW-105 (ON), the vibrator coil, the vibrator actuating point, the vibrator center reed, and back to the batteries. (See fig. 10.) The vibrator starts and causes the center reed to make contact with one set of side reeds. Capacitor CA-385, the actuating point capacitor, quenches the arc caused by opening of the actuating point. With one set of side reeds closed, current flows through the center tap of the transformer, one-half of the transformer winding, one set of the vibrator side reeds, the vibrator center reed, and back to the batteries. (See fig. 11.) On the other half-

cycle of the vibrator, an exactly similar circuit may be traced through the other half of the transformer and the other set of side reeds of the vibrator. (See fig. 12.) The reversal of direction of current flow in the primary produces alternating magnetic flux in the iron core of the transformer.

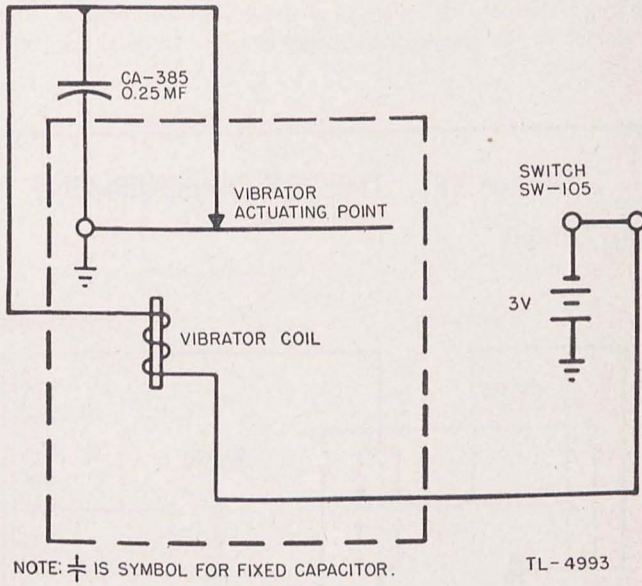

Figure 10. Converter M-222—functional diagram of vibrator actuating point circuit.

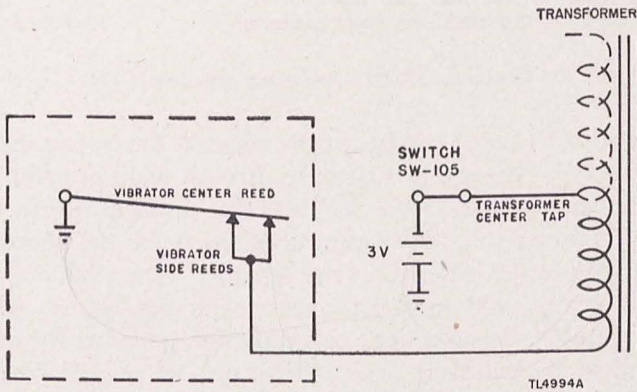

Figure 11. Converter M-222—functional diagram of vibrator circuit, first half cycle.

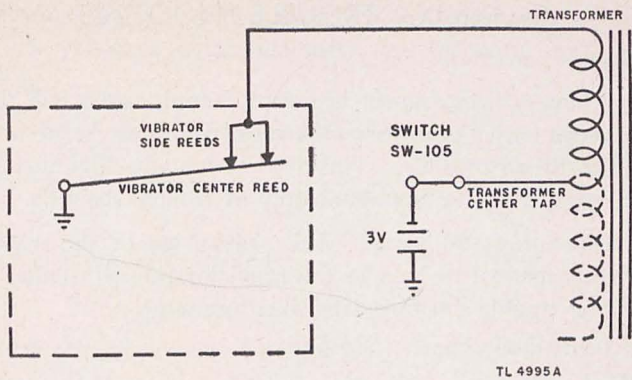

Figure 12. Converter M-222—functional diagram of vibrator circuit, second half-cycle.

23. Output Circuit

The output circuit (fig. 13) consists of the transformer secondary, Capacitor CA-234, and the output receptacle. The reversal of direction of flow in the primary produces alternating magnetic flux in the transformer core, thus producing alternating voltage in the secondary. Capacitor CA-234 acts as a buffer capacitor, regulating the manner in which the magnetic flux decays in the transformer core during the intervals when the primary circuit is open by operation of the vibrator. The output receptacle is connected across the output terminals of the transformer.

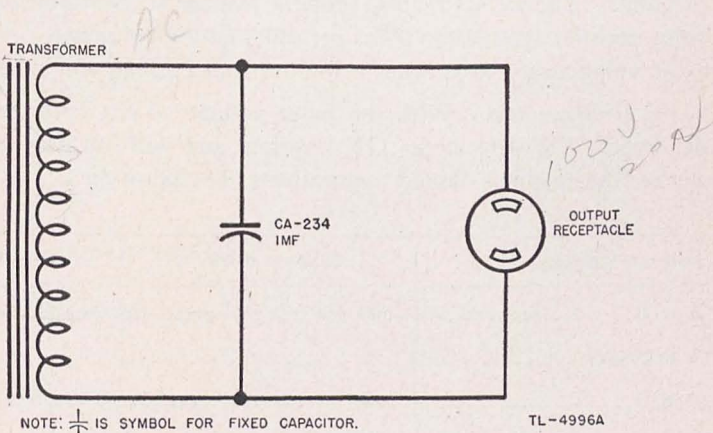

Figure 13. Converter M-222—functional diagram of output circuit.

Section IX. TROUBLE SHOOTING

24. General

No matter how well equipment is manufactured, faults will develop in service. When such faults occur, the repairman must locate and correct them as rapidly as possible. This section contains information to aid personnel engaged in the important duty of trouble shooting.

a. TROUBLE-SHOOTING DATA. Take advantage of the material contained in this manual to help in the rapid location of faults. Consult the following trouble-shooting data when necessary:

- (1) Schematic diagram. (See fig. 14.)
- (2) Wiring diagram. (See fig. 15.)
- (3) Illustrations showing location of parts. (See figs. 2, 3, 4, 18, and 19.)
- (4) Circuit test data. (See par. 25.)
- (5) Trouble-shooting chart. (See par. 26.)

b. TROUBLE-SHOOTING STEPS. The first step in servicing a defective converter is to sectionalize the fault. Sectionalization means tracing the fault to the component or circuit responsible for the abnormal operation or the nonoperation of the converter. The second step is to localize the fault. Localization means the tracing of the fault to the defective part responsible for the condition.

25. Circuit Tests

a. POINT-TO-POINT CHECK. A test of the circuit may be made by a point-to-point check using the schematic diagram (fig. 14) for location of points. The meters required for the test are an a-c voltmeter, 0 to 150 volts, rectifier type, 2,000 ohms per volt; an a-c voltmeter, 0 to 10 volts; a d-c voltmeter, 0 to 5 volts; a low-resistance range ohmmeter.

(1) *Voltage test.* With the input voltage of the batteries 3.1 volts dc, Switch SW-105 in the ON position, and with no load on the converter, the readings should approximate the following:

Points	Readings (volts)	Meter
A to B.....	100 ac	0 to 150 a-c voltmeter.
A to chassis.....	0	
C to D.....	5.7 ac.....	0 to 10 a-c voltmeter.
C to E.....	2.85 ac.....	0 to 10 a-c voltmeter.
D to E.....	2.85 ac.....	0 to 10 a-c voltmeter.
E to chassis.....	3 dc	0 to 5 d-c voltmeter.

(2) *Resistance tests.* Move Switch SW-105 to the OFF position. Using a low-resistance range ohmmeter, the following readings should be obtained:

Points	Resistance (ohms)
A to B	85
A to chassis.....	Infinity.
C to D.....	0.3
C to E.....	0.15
D to E.....	0.15
E to F.....	6
E to chassis.....	6

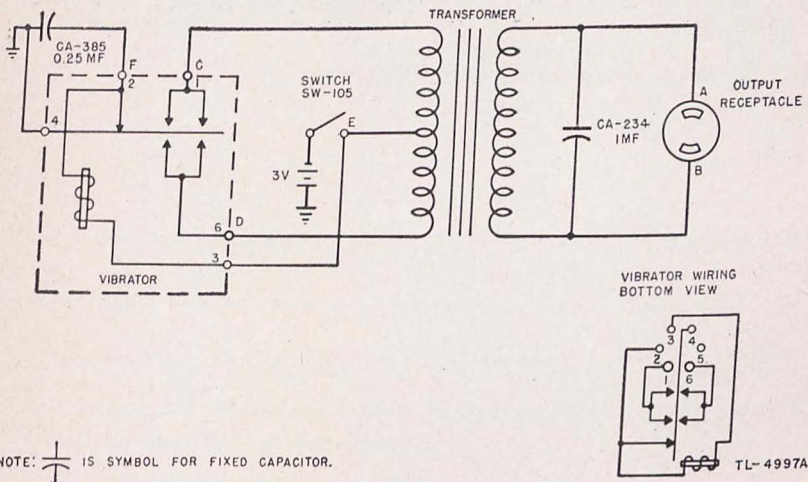

Figure 14. Converter M-222—schematic diagram.

b. CURRENT OUTPUT TEST. If reasonably fresh Batteries BA-23 are installed in Converter M-222, the output of the converter into a non-inductive circuit should be as shown below. The resistance of the output circuit includes that of the measuring instrument, which should be of the thermocouple or equivalent type to avoid errors due to waveform. Values listed in the following table are the minimum output.

Resistance (ohms)	Minimum output (milliamperes)
200	110.0
1,000	52.0
10,000	8.5
100,000	0.9

26. Trouble-shooting Chart

The following trouble-shooting chart, if properly used, will simplify fault location if the converter fails to operate or does not operate satisfactorily. This chart lists the various probable sources of trouble as well as the recommended correction.

a. TEST OF INPUT CIRCUIT. (1) Disconnect the ringing cable from the converter.

(2) Operate Switch SW-105 to ON.

(3) Place a hand on the converter case to detect operation of the vibrator. If no vibration is felt, check for trouble as follows:

Source of trouble	Remedy
1. Batteries incorrectly connected....	1. Check connection of batteries and correct (par. 7.)
2. Batteries dead	2. Check batteries under load. Replace dead batteries.
3. Vibrator loose in socket.....	3. Push vibrator firmly into sockets.
4. Vibrator contacts dirty.....	4. Clean and burnish vibrator contacts (par. 28.)
5. Vibrator contacts out of adjustment or burned.	5. Adjust contacts. The start contact should be made and the side reed contacts open when Switch SW-105 is OFF. Burned contacts indicate a shorted Capacitor CA-385. Replace vibrator if contacts cannot be adjusted, and replace defective Capacitor CA-385.
6. Open in wiring of vibrator coil or transformer primary winding.	6. Check resistance of vibrator coil and primary winding. The resistance of the vibrator coil (E to F, fig. 14) is 6 ohms. The resistance of the transformer primary winding (C to D, fig. 14) is 0.3 ohms. Replace the vibrator or transformer if the coil or winding is defective.
7. Switch SW-105 defective.....	7. Check continuity through switch. Replace if defective.

- b. TEST OF OUTPUT CIRCUIT. (1) Operate Switch SW-105 to OFF.
 (2) Connect a Telephone EE-8-(), with its switch lever depressed, to the output receptacle of the converter.
 (3) Operate Switch SW-105 to ON.

Section X. REPAIRS

27. Replacement of Parts

Remove the four No. 8-32 roundhead steel screws which hold the right cover in place. Remove the right cover.

a. VIBRATOR. Pull the vibrator away from the mounting shelf until the prongs on the base of the vibrator are disengaged from the socket. Before inserting a new vibrator, note the indexing of the socket. Place the vibrator into the socket so that the two large prongs on the vibrator plug fit into the corresponding holes marked 1 and 6 in the socket.

b. OTHER PARTS. Parts other than the vibrator will rarely have to be replaced. Should any other parts have to be replaced, make all wiring connections to the new parts clean and secure. Check the wiring with the wiring diagram. (See fig. 15.) After changing any part, be sure the box, chassis, and wired parts are thoroughly cleaned and free from superfluous particles of solder.

28. Burnishing Vibrator Contacts

a. Failure of the converter to function properly may be traced in some cases to dirty vibrator contacts. The vibrator box may be opened for inspection by removing a small screw at each end of the box and taking off the cover. If an excessive amount of dust has collected on or adjacent to the contact portions of the vibrator, remove the dust with a cleaning brush or with a piece of clean lint-free cloth.

b. When necessary to clean the vibrator contacts, burnish them using a contact burnishing tool. Wipe off the blade of the tool with a clean, dry cloth before burnishing any of the contacts. Insert the blade of the tool between the contacts and press the contacts together manually, giving a slight pressure only on the blade of the burnishing tool. Usually by rubbing the flat side of the blade back and forth between the contacts two or three times, the desired result is obtained. In some cases, where contacts are pitted, additional strokes of the contact burnishing tool may be required. Do not use abrasives other than the blade of the burnishing tool.

c. When unable to clear contact trouble by burnishing only, the contacts may be cleaned and flushed with carbon tetrachloride. Dip the flat end of a clean new toothpick in the carbon tetrachloride to a depth of approximately $\frac{1}{2}$ inch and, without rubbing, deposit the liquid on the contacts (held slightly separated). Dip the flat end of another clean new toothpick in the carbon tetrachloride and again deposit the liquid on the contact, without rubbing, to flush away the dirt which has been loosened by the first application. When the contacts are thoroughly dry, burnish them as explained in *b* above to make sure that no deposit or

residue from the solution or any foreign material remains on the contact.

29. Painting and Refinishing

If the finish on the case has been badly scarred or damaged, the repairman should touch up the bared surface of the case to prevent rust and corrosion. When painting and refinishing are necessary, proceed as follows:

a. Clean the scarred surface down to the bare metal. Use #00 to #000 sandpaper to obtain a bright, smooth finish. To remove rust, first clean the corroded metal with dry-cleaning solvent (SD). For severe rust, use dry-cleaning solvent (SD) to soften the rust and then use sandpaper to remove it.

Caution: Do not use steel wool instead of sandpaper. Minute particles of the metal frequently enter the case and cause harmful internal electrical shorting or grounding of circuits.

b. Before repainting touch up bared metal parts with a primer coat and allow to dry. When a touching-up job is necessary, apply paint with a small brush. When numerous scars and scratches warrant a complete repainting job, remove the chassis from the case and spray-paint the entire case.

30. Unsatisfactory Equipment Report

a. When trouble in equipment used by Army Ground Forces or Army Service Forces occurs more often than repair personnel feel is normal, WD AGO Form 468 (Unsatisfactory Equipment Report) should be filled out and forwarded through channels to the Office of the Chief Signal Officer, Washington 25, D. C.

b. When trouble in equipment used by Army Air Forces occurs more often than repair personnel feel is normal, Army Air Forces Form 54 should be filled out and forwarded to Commanding General, Air Technical Service Command, Wright Field, Dayton, Ohio.

WAR DEPARTMENT UNSATISFACTORY EQUIPMENT REPORT			
FOR	TECHNICAL SERVICE Signal Corps	MATERIEL	DATE 5 July 1945
FROM	ORGANIZATION 209th Signal Repair Depot	STATION AFD 00 San Francisco, Cal.	
TO	NEXT SUPERIOR HEADQUARTERS Signal Officer IV Corps	STATION	TECHNICAL SERVICE Signal Corps
COMPLETE MAJOR ITEM			
NOMENCLATURE	TYPE	MODEL	
Ringling Converter	No. 1254 24-volt		
MANUFACTURER	U. S. A. REG. NO.	SERIAL NO.	DATE RECEIVED
Union Electric Company	Order No. 3456-P-45	48356	28 May 1945
EQUIPMENT WITH WHICH USED (if applicable) Telephone Central Office Set TC-2			
DEFECTIVE COMPONENT—DESCRIPTION AND CAUSE OF TROUBLE			
PART No. Sig C	TYPE	MANUFACTURER	DATE INSTALLED
Stock No 229625-45	Transformer	Union Electric Company	30 May 1945
DESCRIPTION OF FAILURE AND PROBABLE CAUSE (If additional space is required, see back of form) Primary winding of transformer open			
DATE OF INITIAL TROUBLE	TOTAL TIME INSTALLED		TOTAL PERIOD OF OPERATION BEFORE FAILURE
15 June	YEARS	MONTHS	DAYS
		15	YEARS
			MONTHS
			DAYS
			HOURS
			MILES
			ROUNDS
BRIEF DESCRIPTION OF UNUSUAL SERVICE CONDITIONS AND ANY REMEDIAL ACTION TAKEN Temperature 95° Humidity very high. Replaced transformer with spare. Same trouble occurred 10 days later. Replaced with transformer from radio set.			
TRAINING OR SKILL OF USING PERSONNEL		RECOMMENDATIONS (If additional space is required, see back of form)	
POOR	FAIR	GOOD	
		X	Substitute a transformer with a higher current rating.
ORIGINATING OFFICER			
TYPED NAME, GRADE, AND ORGANIZATION		SIGNATURE	
JOHN J. JONES, Captain Sig C 209th Sig Repair Company		<i>John J. Jones</i>	
FIRST ENDORSEMENT			
TO CHIEF	TECHNICAL SERVICE	OFFICE	
NAME, GRADE, AND STATION		STATION	DATE
Instructions			
<p>1. It is imperative that the chief of technical service concerned be advised at the earliest practical moment of any constructional, design, or operational defect in materiel. This form is designed to facilitate such reports and to provide a uniform method of submitting the required data.</p> <p>2. This form will be used for reporting manufacturing, design, or operational defects in materiel, petroleum fuels, lubricants, and preserving materials with a view to improving and correcting such defects, and for use in recommending modifications of materiel.</p> <p>3. This form will not be used for reporting failures, isolated materiel defects or malfunctions of materiel resulting from fire, smoke, anti-air or accidental damage nor for the replacement, repair or the issue of parts and equipment. It does not replace currently authorized operational or performance records.</p> <p>4. Reports of malfunctions and accidents involving ammunition will continue to be submitted as directed in the manner described in AR 750-10 (change No. 3).</p> <p>5. It will not be practicable or desirable in all cases to fill all blank spaces of the report. However, the report should be as complete as possible in order to expedite necessary corrective action. Additional pertinent information not provided for in the blank spaces should be submitted as inclosures to the form. Photographs, sketches, or other illustrative material are highly desirable.</p> <p>6. When cases arise where it is necessary to communicate with a chief of service in order to assure safety to personnel, more expeditious means of communication are authorized. This form should be used to confirm reports made by more expeditious means.</p> <p>7. This form will be made out in triplicate by using or service organization. Two copies will be forwarded direct to the technical service; one copy will be forwarded through command channels.</p> <p>8. Necessity for using this form will be determined by the using or service troops.</p>			
W. D., A. G. O. Form No. 468 30 August 1941		This form supersedes W. D., A. G. O. Form No. 468, 1 December 1941, which may be used until existing stocks are exhausted. TL 5-46805	
U. S. GOVERNMENT PRINTING OFFICE 16-41540-3			

Figure 16. WD AGO Form 468 with sample entries.

WAR DEPARTMENT AAF Form No. 54 (Revised 2-15-54)		WAR DEPARTMENT ARMY AIR FORCES		LEAVE BLANK	
TO BE FILLED IN BY STATION		UNSATISFACTORY REPORT		A. S. C. SERIAL No. REFER TO CLASS	
STATION SERIAL No. SCSG-33-309	DATE SUBMITTED 15 Dec 45	(See AAF Reg. 15-54 for Information on Proper Use of this Form)			
STATION APO 353, c/o PM, San Francisco, Calif.			ORGANIZATION 709th Sig Co, Service Gp.		
SUBJECT OF REPORT Property Class—Name Telephone ES-00		Signal Corps		Manufacturer Blank Co.	
AIRCRAFT—Model & AAF Serial No.		ENGINE—Model & AAF Serial No.		UNIT OR ACCESSORY—Type, Model and Serial No.	
AIRCRAFT REPORTS ONLY LAST D. I. R.—Depot		Date		Flying Time Since	
ENGINE REPORTS ONLY LAST OVERHAUL—Depot		Hours Since		Depots and Hours At Each Previous Overhaul	
Name Handset TS-00, Transmitter Unit		Part, Drawing, Serial and Specification No. 4148799B/3			
Time in Use Unknown		Quantity on Hand 6		Quantity Known Defective 6	
Disposition of Exhibit ➔		Photographed and Price Enclosed		Mail for Instructions	
		Lost Order Service Cover		No. Previous Failures 30	
				Manufacturer Blank Co.	
				Inspector's No. or Identification	
				Required and Returned to Service	
				Disposed of (Explain Below.)	
				To Overhaul Facility (INITIALS)	
GIVE COMPLETE DETAILS, PROBABLE CAUSES AND RECOMMENDATIONS BELOW: (Use Only Applicable Spaces Above—Avoid Unnecessary Repetition)				EXPEDITE	
<p>1. DESCRIPTION OF UNSATISFACTORY CONDITION: The transmitter unit was found to have a very high resistance (5,000 to 100,000 ohms) across its terminals. Corrosion between the diaphragm and the case of the transmitter prevents normal microphone current through the diaphragm to the button. Trouble has been experienced in securing enough transmitter units to keep the handsets in operation.</p> <p>2. PROBABLE CAUSES: The most probable cause for the corrosion between the diaphragm and case of the transmitter is moisture. Although the unit is sealed against moisture, enough gets into the unit to corrode it. Another probable cause is a reaction between the cement used to seal the unit and the aluminum case. Electrolysis undoubtedly adds to both reactions.</p> <p>3. RECOMMENDATIONS: The seal on this unit should be strengthened and a type of cement used that will not react with the aluminum case and diaphragm.</p> <p>4. DISPOSITION: Since transmitter units are expendable all inoperative units were discarded.</p>					
<p><i>James P. Jones</i> JAMES P. JONES 1st Lt, Signal Corps Operations Officer</p>					
UR		ROUTING		UR	
<p>SEND ORIGINAL AND TWO COPIES DIRECT TO COMMANDING GENERAL, HQ. AIR SERVICE COMMAND, PATTERSON FIELD, FAIRFIELD, OHIO. * U. S. GOVERNMENT PRINTING OFFICE: 1944 16-34819-1</p>					
TL 52586S					

Figure 17. AAF Form 54 with sample entries.

Appendix I. REFERENCES

Note. For availability of items listed, check FM 21-6 and ASF Catalog SIG. 2. Also see FM 21-6 for applicable Technical Bulletins, Supply Bulletins, Modification Work Orders, and changes.

1. Army Regulations

AR 380-5, Safeguarding Military Information.

2. Supply Publications

SIG 1, Introduction to ASF Signal Supply Catalog.

SIG 2, Complete Index to ASF Signal Supply Catalog.

SIG 3, List of Items for Troop Issue.

SIG 4-1, Allowances of Expendable Supplies.

SIG 4-2, Allowances of Expendable Supplies for Schools, Training Centers, Boards and Fixed Installations.

SIG 5, Stock List of All Items.

SIG 6, Sets of Equipment.

SIG 7, Organizational Spare Parts.

SIG 8, Higher Echelon Spare Parts.

SB 11-6, Dry Battery Supply Data.

SB 11-76, Signal Corps Kit and Materials for Moisture- and Fungi-resistant Treatment.

3. Technical Manuals on Associated Equipment and Test Equipment

TM 11-332, Telephone Central Office Set TC-4.

TM 11-336, Telephone Central Office Set TC-12.

TM 11-2017, Test Set TS-26/TSM.

TM 11-2613 Voltohmmeter I-166.

4. Shipping Instructions

U. S. Army Specification No. 11-14A, Army-Navy General Specifications for Packaging and Packing for Overseas Shipment.

5. Decontamination

TM 3-220, Decontamination.

6. Demolition

FM 5-25, Explosives and Demolitions.

7. Other Publications

TB SIG 13, Moistureproofing and Fungiproofing Signal Corps Equipment.

TB SIG 66, Winter Maintenance of Signal Equipment.
 TB SIG 72, Tropical Maintenance of Ground Signal Equipment.
 TB SIG 75, Desert Maintenance of Ground Signal Equipment.
 TM 1-455, Electrical Fundamentals.
 TM 11-430, Storage Batteries for Signal Communication Except Those Pertaining to Aircraft.
 TM 11-462, Signal Corps Reference Data.
 TM 11-473, Central Office Maintenance.
 TM 11-486, Electrical Communication Systems Engineering.
 TM 11-487, Electrical Communication Systems Equipment.
 TM 11-498, Fundamental of Telephony and Manual Telegraphy.
 TM 37-250, Basic Maintenance Manual.

8. Forms

WD AGO Form 468, Unsatisfactory Equipment Report.
 AAF Form 54, Unsatisfactory Report.

9. Abbreviations

AAF	Army Air Forces.
ac	alternating current (noun).
a-c	alternating-current (adj).
dc	direct current (noun).
d-c	direct-current (adj).
° F.	degrees Fahrenheit.
diam	diameter.
fig.	figure.
hex.	hexagonal.
ID	inside diameter.
in.	inch.
lb	pound.
mf	microfarad.
MFP	moistureproofed and fungiproofed.
mtg	mounting.
#	number.
No.	number.
OD	outside diameter.
par.	paragraph.
reg	regular.
SD	dry-cleaning solvent.
Sig C	Signal Corps.
v	volt.
WD AGO	War Department, Adjutant General's Office.

Appendix II. MAINTENANCE PARTS

I. Maintenance Parts for Converter M-222

The following information was compiled on 30 October 1945. The appropriate pamphlets of the ASF Signal Supply Catalog for Converter M-222 are—

Organizational Spare Parts: SIG 7-TC-4.

Higher Echelon Spare Parts: SIG 8-M-222.

For an index of available catalog pamphlets, see the latest issue of ASF Signal Supply Catalog SIG 2.

Note. The following list covers first, second, and third echelon maintenance parts.

Reference No.	Signal Corps stock No.	Name
Figs. 3 and 4.....	3D234	CAPACITOR CA-234.
Fig. 4.....	3D385	CAPACITOR CA-385.
Fig. 6.....	4F222/J1	INSULATOR: fiber.
Fig. 18 (1).....	4F222/L1.....	LABEL, circuit.
Fig. 1.....	6Z7788	RECEPTACLE: (input).
Fig. 4.....	2Z8659-7	SOCKET: (vibrator).
Fig. 19 (8).....	6L30555	SPACER: $\frac{3}{8}$ " OD x 3/16" ID x $\frac{3}{4}$ "; (socket mtg).
Figs. 1, 3, and 4..	3Z8105	SWITCH SW-105.
Fig. 18 (2).....	3Z12050-1	TERMINAL, lug: (ring type).
Figs. 3 and 4.....	4F222/T1	TRANSFORMER ASSEMBLY: (power).
Figs. 3 and 4.....	4F222/V1	VIBRATOR.
<i>General Hardware</i>		
Figs. 18 and 19 (6)	6L3106-32.1S ..	NUT, hex.: #6-32 (miscellaneous parts mtg and chassis assembly).
Fig. 18 (3).....	6L6632-5.8S ..	SCREW, machine: #6-32 x 5/16"; (ca- pacitor and transformer mtg and vi- brator cover fastening).
Fig. 18 (4).....	6L6632-16.9S ..	SCREW, machine #6-32 x 1"; (vibrator socket mtg).
Fig. 19 (7).....	6L6832-4.9S ...	SCREW, machine: #8-32 x $\frac{1}{4}$ "; (cover fastening and receptacle mtg).
Fig. 18 (5).....	6L73006	WASHER: SAE reg. for #6 screw; (capacitor, transformer, and socket mtg and chassis assembly).

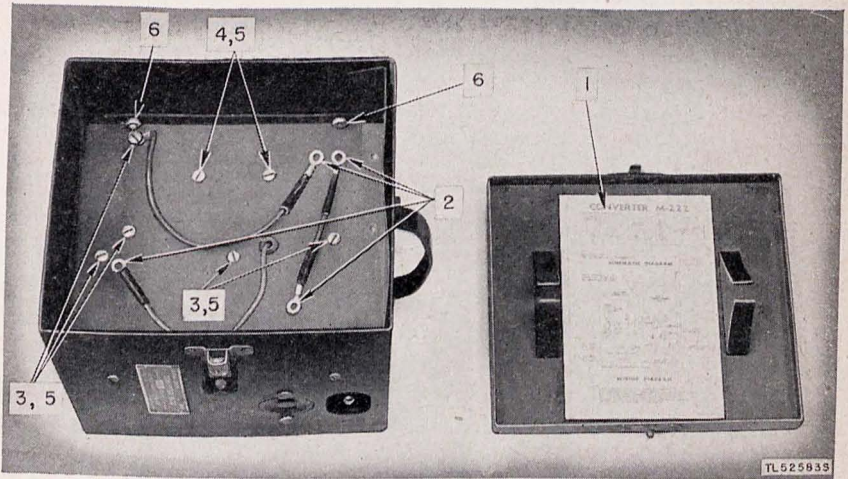

Figure 18. Converter M 222—battery compartment, identification of parts.

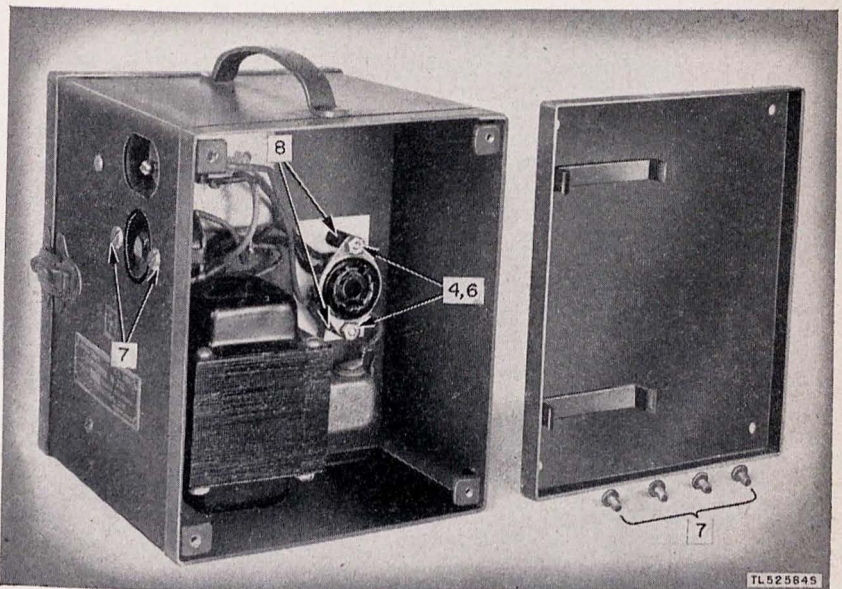

Figure 19. Converter M-222—right cover removed, identification of parts

