

RESTRICTED



**SIGNAL SECTION
AIR SERVICE COMMAND**

SC
3585
A

Airborne Radio

EQUIPMENT HANDBOOK



SIGNAL SECTION...AIR SERVICE COMMAND
PATTERSON FIELD FAIRFIELD, OHIO



RESTRICTED

SIGNAL SECTION
AIR SERVICE COMMAND

AIRBORNE RADIO EQUIPMENT MANUAL

ISSUE 1

April, 1943

Signal Section, Air Service Command
Patterson Field, Fairfield, Ohio

April 1943

Revised 21 February 2001

RESTRICTED

LIST OF REVISED PAGES ISSUED

NOTE: A heavy black vertical line, to the left of the text on revised pages, indicates the extent of the revision. This line is omitted where more than 50 percent of the page is revised.

Page No.	Latest Revised Date
Title page....	21 February 2001
150	13 November 1991
162	21 February 2001

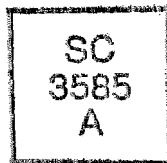

13 NOVEMBER, 1991

ERRATA SHEET

**AIRBORNE RADIO EQUIPMENT HANDBOOK
DATED 24 APRIL, 1943**

Make the following corrections to Airborne Radio Equipment Handbook of 24 April, 1943:

- Page 150 - Change "I-81-A" to "I-82-A".
- Page 150 - Change "I-82-A" to "I-81-A".
- Page 150 - Change "PILOT'S" to "NAVIGATOR'S"
- Page 150 - Change "NAVIGATOR'S" to "PILOT'S"

Insert this sheet behind the title page after the changes are made.

This Page Intentionally Blank

THIS MANUAL IS JUST A GUIDE

The equipment listed per plane may vary with planes of certain serial numbers. The list shown is correct in the majority of cases.

The interchangeable and substitution list is tentative, so in cases of doubt consult the radio repair shop.

Notify this headquarters of any errors found.

Notify this headquarters of any helpful additions.

INTRODUCTION

This is the first of a series of picture supply manuals. It is hoped that it will be of help to Air Service Command Supply Officers. There will be mistakes in this manual, as in all others, but these mistakes will be corrected from time to time. It is requested that any errors found be reported to the Signal Officer, Air Service Command.

PURPOSE

The prime purpose of this manual is to "speed up" the training of inexperienced supply officers and help them get familiar with the actual airborne radio equipment in the shortest period of time. It is impossible to picture every piece of equipment, but the most frequently used will be shown. Due to various reasons, some of the popular equipment has been left out.

It is also intended that experienced Air Service Command Supply Officers will use this manual as a ready reference.

As soon as possible another manual will be prepared including equipment that was left out. New items will be added to the next publication.

NOTE

Sets and component parts of confidential nature have been left out of this manual but will appear in a future manual. This was done to speed up distribution.

GENERAL INDEX

	PAGE
1. Chart Showing a Typical Army Air Force	3
2. Index to Illustrations of Airplanes	4
3. Index to Complete Radio Sets and Equipment (by SCR or RC Type Numbers)	5
4. Index to Component Units by Type Number	6
5. Index to Illustrations of Sets, Equipment, and Component Parts by Name, that is Dynamotor, Jack Boxes, Amplifiers, etc.	12
6. Direct Interchangeability and Substitution Guide	18
7. Dynamotor Interchangeability List	21
8. General Substitution Information on:	23
(a) Control Boxes	23
(b) Dynamotors and Dynamotor Units	23
(c) Head Sets	24
(d) Marker Beacons	24
(e) Microphones	24
(f) British Plugs	25
(g) Test Sets	26
(h) Transmitters	26
(i) Receivers	27
(j) Relays	28
(k) SCR Radio Sets	29
9. Interchangeability of Instruction Books	31
10. Test Equipment-Airborne Radio Sets	39

GENERAL INDEX

	PAGE
11. Equipment Cross Reference Chart (Sets and Their Component Parts)	41
12. Chart Showing Equipment and List of Planes Using the Equipment	42
13. Chart Showing List of Airplanes and Various Sets and Equipment Used in Each	43
14. Illustrations of Airplanes Listing Radio Equipment Used in Each	45
15. Outline of Airplanes Showing Location of Radio Equipment in the Airplanes	57
16. Illustrations and General Description of Complete SCR Radio Sets and RC Equipment	69
17. Illustrations of Component Parts	108
18. Chart Showing Floor Plan of Domestic Requisitions	171
19. General Discussion of Supply, Accountability, and Responsibility	172

ARMY AIR FORCE (TYPICAL)

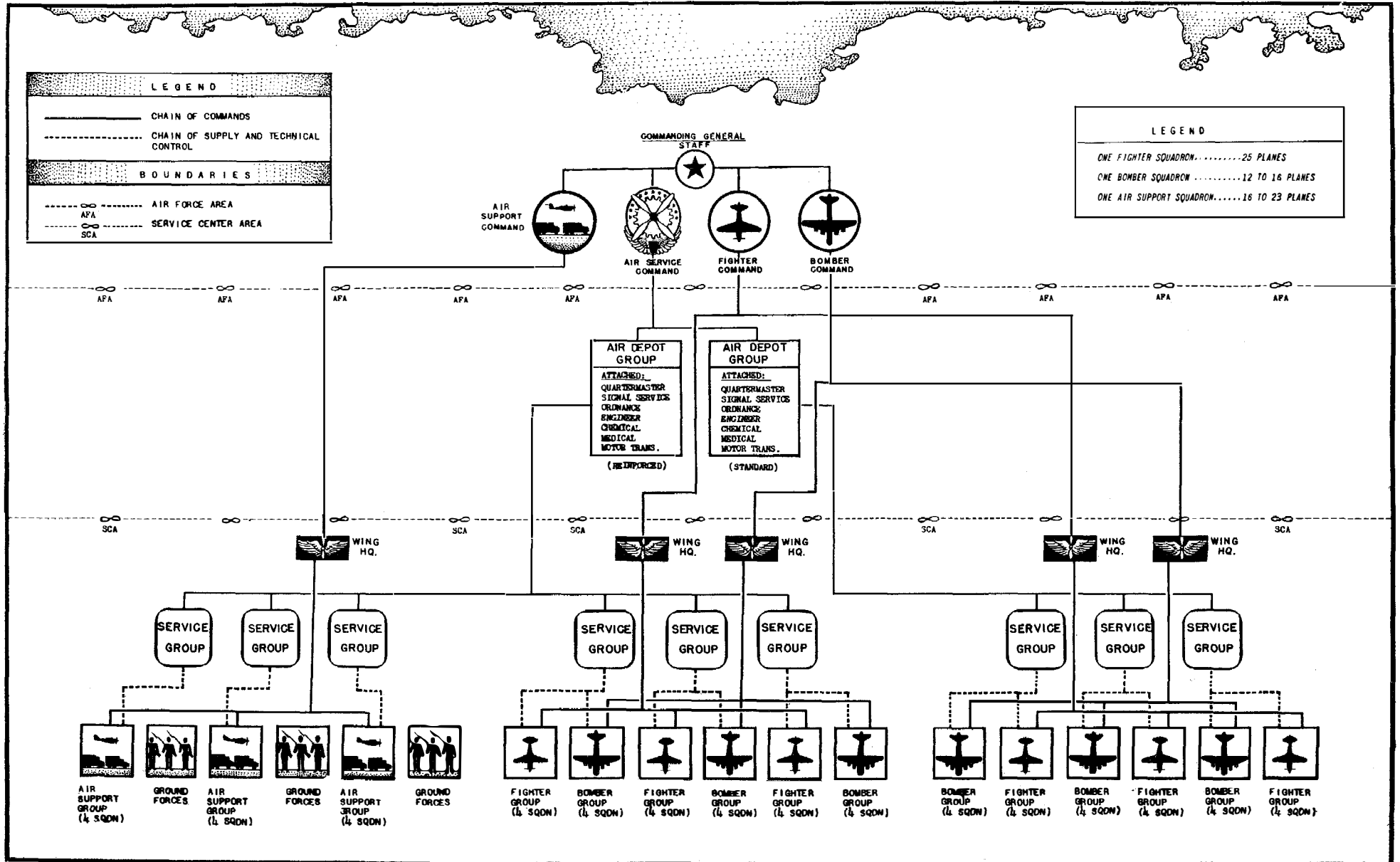

- 3 -

INDEX TO ILLUSTRATIONS OF AIRPLANES

		PAGE
A-20	Douglas Boston Bomber	45
B-17	Boeing Flying Fortress	46
B-24	Consolidated Liberator	47
B-25	Mitchell Bomber	48
B-26	Martin Marauder	49
C-46	Curtiss Commando	50
C-47	Douglas DC-3 Skytrain	51
C-54	Douglas Skymaster	52
P-38	Lockheed Lightning	53
P-39	Bell Aircobra	54
P-40	Curtiss Kittyhawk	55
P-51	North American Mustang	56

*

INDEX OF COMPLETE RADIO SETS AND EQUIPMENT

		PAGES
RC-32	Filter Equipment	69 - 70
RC-36	Interphone Amplifier Equipment	71 - 72
RC-39-A	Marker Beacon Equipment	73 - 74
RC-43-A	Marker Beacon Equipment	75 - 76
RC-45	Interphone Equipment	77 - 78
RC-51	Interphone Equipment	79 - 80
RC-96-A	Contacting Equipment	81 - 83
SCR-AJ-183	Command Set (transmitter and receiver)	84 - 85
SCR-187-A	Liaison Set (transmitter and receiver)	86 - 88
SCR-211-N	Frequency Meter Set	89 - 90
SCR-269-G	Automatic Radio Compass	91 - 93
SCR-274-N	Command Radio Set (transmitter and receiver)	94 - 96
SCR-280-A	Radio Compass	97 - 98
SCR-287-A	Liaison Radio Set (transmitter and receiver)	99 - 101
SCR-522-A	VHF Radio Set (transmitter and receiver)	102 - 103
SCR-578-A	Emergency Sea Rescue Transmitter	104 - 106
#-438	Detrola Radio Range Receiver	107

NOTE: The SCR-AJ-183 radio set is used in this manual for illustrative purposes only. The SCR-AL-183 and later series (AN, AO, etc.) is now used. Physically the SCR-AJ-183 components look the same as the SCR-AL-183 series and later. See Signal Corps Stock Catalog for correct listing of component units.

NOTE: The SCR-()-283 radio set will be used in the new C-47 and the C-53 planes as they have a 28-volt supply.

INDEX TO COMPONENT UNITS BY TYPE NUMBER

TYPE NUMBER	ITEM AND DESCRIPTION	PART OF	PAGE
BC-212-C	Interphone Amplifier	RC-45	108
BC-224-F	Radio Receiver	SCR-187-A	109
BC-AH-229	Radio Receiver	SCR-AJ-183	110
BC-AH-230	Radio Transmitter	SCR-AJ-183	111
BC-AH-231	Radio Control Box - Receiver	SCR-AJ-183	112
BC-AE-232	Radio Control Box - Transmitter	SCR-AJ-183	112
BC-306-A	Antenna Tuning Unit		113
BC-309	Radio Control Box		114
BC-341-B	Marker Beacon Receiver	RC-39-A	115
BC-345	Filter Switch Box	RC-32	116
BC-348-H	Radio Receiver	SCR-287-A	117
BC-357-B	Marker Beacon Receiver	RC-43-A	118
BC-375-C	Radio Transmitter	SCR-287-A	119
BC-431-A	Radio Compass Unit	SCR-280-A	120
BC-432-B	Radio Compass Control Box	SCR-280-A	121
BC-433-G	Radio Compass Unit	SCR-269-G	122
BC-434-A	Radio Compass Control Box	SCR-269-G	123
BC-442-A	Antenna Relay Unit	SCR-274-N	123
BC-450-A	Receiver Control Box	SCR-274-N	124
BC-451-A	Transmitter Control Box	SCR-274-N	124
BC-453-A	Radio Receiver	SCR-274-N	125

TYPE NUMBER	ITEM AND DESCRIPTION	PART OF	PAGE
BC-454-A	Radio Receiver	SCR-274-N	125
BC-455-A	Radio Receiver	SCR-274-N	125
BC-456-A	Modulator Unit	SCR-274-N	126
BC-457-A	Radio Transmitter	SCR-274-N	127
BC-458-A	Radio Transmitter	SCR-274-N	127
BC-461	Reel Control Box	SCR-287-A	128
BC-602-A	VHF Radio Control Box	SCR-522-A	129
BC-608-A	Contacting Unit	RC-96	130
BC-616	Relay Control Box	RC-96	131
BC-624-A	VHF Radio Receiver	SCR-522-A	132
BC-625-A	VHF Radio Transmitter	SCR-522-A	132
BC-778-A	Radio Transmitter	SCR-578-A	133
BD-77-D	Dynamotor Unit	SCR-187-A	134
BD-AG-83	Dynamotor Unit	SCR-AJ-183	135
BK-21-B	Relay	SCR-280-A	136
BK-22-A	Relay	SCR-269-G	136
C-155-A	Dual Receiver Coil Set	SCR-AJ-183	137
C-218	Transmitter Coil Set	SCR-AJ-183	137
CD-307-A	Cord - Head Set Extension		138
CD-318	Cord - Microphone Extension		138
CD-365	Cord	SCR-269-G	139

TYPE NUMBER	ITEM AND DESCRIPTION	PART OF	PAGE
DC-9-N	Crystal Unit	SCR-211-N	140
DM-20-A	Dynamotor	BC-431-A	140
DM-28-C	Dynamotor	BC-348-C	140
DM-28-H	Dynamotor	BC-348-H	140
DM-32-A	Dynamotor	SCR-274-N	141
DM-33-A	Dynamotor	SCR-274-N	141
F-8	Fair-lead		142
FL-5-E	Radio Filter	RC-32	143
FT-213-A	Mounting	BC-433-G	144
FT-224-A	Mounting	BC-434-A	145
GC-18-A	Crank		146
HS-23	Heat Set		147
I-65-D	Radio Compass Indicator	SCR-280-A	148
I-71-B	Ammeter	SCR-274-N	148
I-75-A	Bearing Indicator	SCR-280-A	148
I-76	Marker Beacon Test Set		149
I-81-A	Pilots Bearing Indicator	SCR-269-G	150
I-82-A	Navigators Bearing Indicator	SCR-269-G	150
JB-29-A	Junction Box	SCR-522-A	151

TYPE NUMBER	ITEM AND DESCRIPTION	PART OF	PAGE
JK-26	Jack	CD-307-A	151
LM-58-A	Lamp	SCR-578-A	146
LP-19-A	Radio Compass Loop	SCR-289-A	152
LP-21-A	Radio Compass Loop	SCR-269-G	153
MC-124-	Tuning Shaft	SCR-AJ-183	154
MC-162	Cushion - Head Set	HS-23	147
MC-203-A	Coupling	SCR-269-G	154
MC-211-A	Coupling	SCR-269-G	154
P-18	Head Set		155
P-20	Head Set		155
PE-73-C	Dynamotor Unit	SCR-287-A	156
PE-94-A	Dynamotor Unit	SCR-522-A	157
PE-109	Alternator		158
PL-55	Plug		159
PL-68	Plug		159
RL-30-B	Antenna Reel	SCR-187-A	164
RL-42-A	Automatic Antenna Reel	SCR-287-A	165
T-17	Hand Microphone		166
T-30	Throat Microphone		166
T-34-A	Oxygen Mask Microphone		166

TYPE NUMBER	ITEM AND DESCRIPTION	PART OF	PAGE
T-44	Oxygen Mask Microphone		166
TM-AH-172	Junction Box	SCR-AJ-183	167
TM-187	Antenna Lead-In Terminal	RC-43-A	170
TU-5-A	Transmitting Tuning Unit	SCR-287-A	168
WC-537	Cable	RC-43-A	170
WC-538	Cable	RC-43-A	170
WT-7-A	Antenna Weight	SCR-287-A	167

NOTE: The SCR-AJ-183 radio set is used in this manual for illustrative purposes only.

The SCR-AL-183 and later series (AN, AO, etc.) is now used. Physically the SCR-AJ-183 components look the same as the SCR-AL-183 series and later. See Signal Corps Stock Catalog for correct listing of component units.

NOTE: The SCR-()-283 radio set will be used in the new C-47 and the C-53 planes as they have a 28-volt supply.

This Page Intentionally Blank

INDEX TO COMPONENT UNITS BY NAME OF ITEMS

ITEMS AND DESCRIPTION	TYPE NUMBER	PART OF	PAGE
Alternator	PE-109		158
Ammeter	I-71-B	SCR-274-N	148
Amplifier, Interphone	BC-212-C	RC-45	108
Cable	WC-537	RC-43-A	170
Cable	WC-538	RC-43-A	170
Coil Set, Receiver (dual)	C-155-A	SCR-AJ-183	137
Coil Set, Transmitter	C-218	SCR-AJ-183	137
Compass Unit, Radio	BC-431-A	SCR-280-A	120
Compass Unit, Radio	BC-433-G	SCR-269-G	122
Contacting Unit	BC-608-A	RC-96	130
Control Box, Compass	BC-432-B	SCR-280-A	121
Control Box, Compass	BC-434-A	SCR-269-G	123
Control Box, Radio	BC-309	SCR-187-A	114
Control Box, VHF Radio	BC-602-A	SCR-522-A	129
Control Box, Reel	BC-461	SCR-287-A	128
Control Box, Radio Receiver	BC-AH-231	SCR-AJ-183	112
Control Box, Radio Receiver	BC-450-A	SCR-274-N	124
Control Box, Relay	BC-616	RC-96	131
Control Box, Transmitter	BC-AE-232	SCR-AJ-183	112
Control Box, Transmitter	BC-451-A	SCR-274-N	124

ITEMS AND DESCRIPTION	TYPE NUMBER	PART OF	PAGE
Cord	CD-365	SCR-269-G	139
Cord, Head Set Extension	CD-307-A		138
Cord, Microphone	CD-318		138
Coupling	MC-203-A	SCR-269-G	154
Coupling	MC-211-A	SCR-269-G	154
Crank	GC-18-A	SCR-578-A	146
Crystal Unit	DC-9-N	SCR-211-N	140
Cushion, Head Set	MC-162	HS-23	147
Dynamotor	DM-20-A	BC-431-A	140
Dynamotor	DM-28-C	BC-348-C	140
Dynamotor	DM-28-H	BC-348-H	140
Dynamotor	DM-32-A	SCR-274-N	141
Dynamotor	DM-33-A	SCR-274-N	141
Dynamotor Unit	BD-77-D	SCR-187-A	134
Dynamotor Unit	BC-AG-83	SCR-AJ-183	135
Dynamotor Unit	PE-73-C	SCR-287-A	156
Dynamotor Unit	PE-34-A	SCR-522-A	157
Fair-lead	F-8		142
Filter, Radio	FL-5-E	RC-32	143

ITEMS AND DESCRIPTION	TYPE NUMBER	PART OF	PAGE
Head Set	HS-23		147
Head Set	P-18		155
Head Set	P-20		155
Indicator, Radio Bearing	I-75-A	SCR-280-A	148
Indicator, Navigators Bearing	I-82-A	SCR-269-G	150
Indicator, Pilots Bearing	I-81-A	SCR-269-G	150
Indicator, Radio Compass	I-65-D	SCR-280-A	148
Jack	JK-26	CD-307-A	151
Junction Box	JB-29-A	SCR-522-A	151
Junction Box	TM-AH-172	SCR-AJ-183	167
Lamp	LM-58-A	SCR-578-A	146
Loop, Radio Compass	LP-19-A	SCR-280-A	152
Loop, Radio Compass	LP-21-A	SCR-269-G	153
Microphone, Hand	T-17		166
Microphone, Oxygen Mask	T-34-A		166
Microphone, Oxygen Mask	T-44		166
Microphone, Throat	T-30		166

ITEMS AND DESCRIPTION	TYPE NUMBER	PART OF	PAGE
Modulator Unit	BC-456-A	SCR-274-N	126
Mounting	FT-213-A	BC-433-G	144
Mounting	FT-224-A	BC-434-A	145
Oscillator, Test	BC-376	I-76	149
Plug	PL-55		159
Plug	PL-68		159
Receiver, Marker Beacon	BC-341-B	RC-39-A	115
Receiver, Marker Beacon	BC-357-B	RC-43-A	118
Receiver, Radio	BC-224-F	SCR-187-A	109
Receiver, Radio	BC-AH-229	SCR-AJ-183	110
Receiver, Radio	BC-348-H	SCR-287-A	117
Receiver, Radio	BC-453-A	SCR-274-N	125
Receiver, Radio	BC-454-A	SCR-274-N	125
Receiver, Radio	BC-455-A	SCR-274-N	125
Receiver, Radio (VHF)	BC-624-A	SCR-522-A	132
Reel, Antenna	RL-30-B	SCR-187-A	164
Reel, Antenna (automatic)	RL-42-A	SCR-287-A	165
Relay	BK-21-B	SCR-280-A	136

ITEMS AND DESCRIPTION	TYPE NUMBER	PART OF	PAGE
Relay	BK-22-A	SCR-269-G	136
Relay Unit, Antenna	BC-442-A	SCR-274-N	123
Shaft, Tuning	MC-124	SCR-AJ-183	154
Switch Box, Filter	BC-345	RC-32	116
Terminal, Antenna Lead-In	TM-187	RC-43-A	170
Test Set, Marker Beacon	I-76		149
Transmitter, Radio	BC-AH-230	SCR-AJ-183	111
Transmitter, Radio	BC-375-C	SCR-287-A	119
Transmitter, Radio	BC-457-A	SCR-274-N	127
Transmitter, Radio	BC-458-A	SCR-274-N	127
Transmitter, Radio	BC-778-A	SCR-578-A	133
Transmitter, Radio (VHF)	BC-625-A		132
Tubes (used in BC-375-C)			169
Tuning Unit, Antenna	BC-306-A	SCR-287-A	113
Tuning Unit, Transmitter	TU-5-A	SCR-287-A	168
Weight, Antenna	WT-7-A	SCR-287-A	167

This Page Intentionally Blank

DIRECT INTERCHANGEABILITY AND SUBSTITUTION GUIDE

S. C. STOCK NUMBER	ITEM	INTERCHANGEABLE WITH
BC - AL - 408	Antenna Relay	BC - AN - 408
BC - AN - 408	Antenna Relay	BC - AL - 408
BC - AL - 232	Control Box	BC - AN - 232
BC - AN - 232	Control Box	BC - AL - 232
BC - AL - 430	Radio Transmitter	BC - AN - 430 BC - AO - 430
BC - AN - 430	Radio Transmitter	BC - AL - 430 BC - AO - 430
BC - AO - 430	Radio Transmitter	BC - AL - 430 BC - AN - 430
BC - AL - 429	Radio Receiver	BC - AN - 429 BC - AO - 429
BC - AN - 429	Radio Receiver	BC - AL - 429 BC - AO - 429
BC - AO - 429	Radio Receiver	BC - AL - 429 BC - AN - 429
BC - AH - 230	Radio Transmitter	BC - AL - 230 BC - AN - 230 BC - AO - 230
BC - AL - 230	Radio Transmitter	BC - AH - 230 BC - AN - 230 BC - AO - 230
BC - AN - 230	Radio Transmitter	BC - AH - 230 BC - AL - 230 BC - AO - 230

S. C. STOCK NUMBER	ITEM	INTERCHANGEABLE WITH
BC - AO - 230	Radio Transmitter	BC - AH - 230 BC - AL - 230 BC - AN - 230
BC - AH - 229	Radio Receiver	BC - AL - 229 BC - AN - 229 BC - AO - 229
BC - AL - 229	Radio Receiver	BC - AH - 229 BC - AN - 229 BC - AO - 229
BC - AN - 229	Radio Receiver	BC - AH - 229 BC - AL - 229 BC - AO - 229
BC - AO - 229	Radio Receiver	BC - AH - 229 BC - AL - 229 BC - AN - 229
P-18	Head Set	P-20
P-20	Head Set	P-18
T - 30 - A)	Microphone	T - 20 - A
T - 30 - B)		T - 20 - B
T - 30 - C)		T - 20 - C
T - 34	Microphone	T - 34 - A
T - 34 - A	Microphone	T - 34

S. C. STOCK NUMBER	ITEM	INTERCHANGEABLE WITH
BC - 348 - H	Radio Receiver	BC - 348 - I BC - 348 - J BC - 348 - K
BC - 348 - I	Radio Receiver	BC - 348 - H BC - 348 - J BC - 348 - K
BC - 348 - J	Radio Receiver	BC - 348 - H BC - 348 - I BC - 348 - K
BC - 348 - K	Radio Receiver	BC - 348 - H BC - 348 - I BC - 348 - J

DYNAMOTOR INTERCHANGEABILITY LIST

The following listed dynamotors are interchangeable as shown in groups:

(Example: All dynamotor units in group 7 are interchangeable.
All dynamotor units in group 12 are interchangeable, etc.)

NOTE: No interchangeability exists between groups.

GROUP 1	GROUP 2	GROUP 3	GROUP 4
BD-AA-69	BD-AA-77*	BD-AD-81	BD-AE-83
BD-AB-69	BD-BB-77*	BD-AE-81	BD-AG-83
BD-AC-69	BD-CC-77	BD-AH-81	BD-AD-83
BD-AD-69	BD-DD-77	BD-AJ-81	BD-AL-83
BD-AE-69	BD-77-A		BD-AN-83
BD-BC-69	BD-77-B		BD-AO-83
BD-BF-69	BD-77-C		BD-AP-83
BD-BG-69	BD-77-D		BD-87-A**
BD-BH-69			BD-87-B**
BD-BJ-69			BD-87-C**
			BD-87-D**
			BD-87-E**
			BD-87-F**

* These dynamotor units have input and output cordage connection facilities incorporated in the base of the machine. They are replaceable with other dynamotors of this group subject to installation limitations.

** Dynamotors listed in group 4 for which this symbol is shown are replaceable with dynamotors listed in that group for which the symbol is not shown, but not vice versa. Internal voltage divider should be examined to determine if properly connected for operation.

GROUP 5	GROUP 6	GROUP 7	GROUP 8
BD-AF-83	BD-86-A	BD-AL-93	DM-18
BD-87-A***	BD-86-B	BD-AN-93	DM-18-A
BD-87-B***		BD-AO-93	DM-18-B
BD-87-C***		BD-AQ-93	
BD-87-D***		BD-AR-93	
BD-87-E***			
BD-87-F***			

*** Dynamotors listed in group 5 for which this symbol is shown are replaceable with dynamotor listed in that group for which the symbol is not shown, but not vice versa. Internal voltage divider should be examined to determine if properly connected for operation.

GROUP 9	GROUP 10	GROUP 11	GROUP 12
DM-20	DM-21-A	DM-24-B	DM-28-B
DM-20-A	DM-21-B	DM-24-C	DM-28-C
	DM-21-E	DM-24-F	DM-28-H
	DM-21-G		DM-28-J
			DM-28-K
GROUP 13	GROUP 14	GROUP 15	
PE-73-B	PE-86-A	PE-91-B	
PE-73-C	PE-86-B	PE-91-C	
	PE-86-C	PE-91-D	
	PE-86-D	PE-91-E	

NOTE: Refer to AAF T. O. No. 00-30-69 for current list.

CONTROL BOXES.

CONTROL BOXES (SCR 240 and 261). All parts of the radio control boxes are identical except for the resistor lamp series resistors: 514-1, 514-2, 514-3, 514-4, and 528-1, 528-2, 528-3, and 528-4.)

Bendix control box MRGC may be substituted for MRGB Bendix control, but High Z (impedance) phones must be used with MRGC, and Low Z phones must be used with MRGB.

DYNAMOTORS AND DYNAMOTOR UNITS.

Dynamotor PE-86-() Stock No. 3H1886 ()

Substitute Information.

1. The PE-86-A, PE-86-B, and PE-86-D dynamotors are interchangeable as complete units.
2. The DM-32-A is identical with the above dynamotors except that it does not have the same mounting, and has no filter equipment.
DM-32-A (and PE-86-A, -B, -C, -D are interchangeable except that DM-32-A has no filter equipment).
3. Dynamotor DM-CM-15 may be substituted for DM-13, DM-13-A, DM-13-B, and DM-13-C, but not vice versa.
4. Dynamotors DM-13-B and DM-13-C may be substituted for DM-13-A and DM-13, but not vice versa.

5. Dynamotor units BD-AD-81 and BD-AE-81 may be substituted for dynamotor units BD-69, BD-AA-69, BD-AC-69, BD-AE-69, and BD-BP-69 but not vice versa.

6. Dynamotor unit BD-AE-83 is interchangeable with BD-87-() as tap is located in the base of the BD-87 -() to make it universal.

7. Dynamotor unit BD-AF-83 and BD-87-() are interchangeable by proper tap setting.

HEAD SETS.

HEAD SETS P-23 (for HS-23 by shortening cord and changing plug).

MARKER BEACONS.

RC- INTERCHANGEABILITY (RC-39 and RC-43 are identical except that resistors 29 and 30 are inserted in the 24-volt set.

RC- INTERCHANGEABILITY (RC-26 and RC-27 are identical except that RC-27 has a remote control box and a control cable in addition. The additional equipment follows: BC-327 - remote control box; MC-166 - control shaft.

MICROPHONES.

Microphone T-30-M to be substituted for any other T-30 microphones. T-30-A microphones are not to be supplied.

Microphone T-42 microphone-carbon used in place of microphone T-30 and T-17 are designed to fit in A-9 or A-10 oxygen mask.

Microphone T-20 may be replaced by T-30 microphone with CD-508 cord, provided the radio control box has been made accessible.

PLUGS.

British Plugs	U. S. Signal Corps Plug Substitute
10 H/254 B	PL-183 or PL-172
10 H/258 B	PL-182 or PL-174
10 H/256 B	PL-183
10 H/417	PL-170
10 H/738 5	PL-180
10 H/399	PL-P 165
10 H/584	PL-P 173
10 H/499	PL-P 172
10 H/507	PL-Q 173
10 H/416	PL-Q 169
10 H/403	PL-P 167
10 H/415	PL-P 169
10 H/404	PL-Q 167
10 H/413	PL-P 171
10 H/460	PL- 177
10 H/13079	PL- 265
10 H/701	PL-Q 187
10 H/261 B	SO- 158

TEST SETS: -

Commercial substitutes for signal generator 1-72-B

- Precision E-200 signal generator
- Weston model 776 oscillator
- Supreme model 571 signal generator
- Jackson model 640 test oscillator
- RCA No. 167A test oscillator
- Triumph model 131

TRANSMITTERS: -

BC-191-C and BC-375-C (All parts are interchangeable except the following);

BC-191-C PARTS

<u>Reference No.</u>	<u>Stock or Renewal Part No.</u>	<u>Item</u>
1187	(R-16)	Pilot Lamp Res.
1196	(R-15)	Filament Res.
1189	(Rel-4)	Rel-4 Relay
1191	(R-17)	Filament Res.
1192	(R-17)	Filament Res.
1193	(R-18)	Microphone Res.

BC-375-C PARTS

<u>Reference No.</u>	<u>Stock or Renewal Part No.</u>	<u>Item</u>
1123	(R-6)	Pilot Lamp Res.
1124	(R-6)	Pilot Lamp Res.
1125	(2Z8754)	Socket SO-54- Plug Rec.

BC-375-C PARTS
(Continued)

<u>Reference No.</u>	<u>Stock or Renewal Part No.</u>	<u>Item</u>
1130	(J-2)	Key Jack
1138	(R-7)	Filament Res.
1152	(R-10)	Filament Res.
1153	(R-10)	Filament Res.
1165	(Rel-1)	Relay
1173	(2Z8754)	SO-54
1174	(2Z8741)	SO-41
1175	(2Z8739)	SO-39
1176	(2Z8739)	SO-44
1177	(J-1)	Microphone Jack
1178	(J-2)	Key Jack
1182	(R-8)	Microphone Res.
1195	(CSW-4)	AC-DC Switch

RECEIVERS: -

All parts of the BC-224-B and BC-348-B are interchangeable except the following:

<u>Item</u>	<u>BC-348-B</u>	<u>BC-224-B</u>
Dial rheostat	Part 500	Part 60
Resistor	501	54 and 55
Fuse	502	118
Resistor	503	
Fuse clip assy	504	216
Dynamotor	510	300

The SCR-276-A is the same as the SCR-246-A, but has the following changes:

Dynamotor DM-29-A (12v)	replaced by DM-39-A
Relay ref No. 110 (12v)	replaced by relay ref No. 111
Pilot light drop resistor ref No. 203	replaced by res. ref No. 227
Filament circuit rewired	replaced by res. ref No. 226

BC-348-H Receivers. Receivers used in SCR-287, namely BC-348 prior to model 348-H, are not provided with coverage of the 200-to 500-kilocycle band. Models 348-H and later have this band.

There is no difference between models BC-348-H, BC-348-I, BC-348-J, and BC-348-K. They are interchangeable, identical in band coverage, and employ the same construction.

It is imperative that planes scheduled for overseas operations have coverage of the 200-to 500-kilocycle band. A directive was issued by this office on August 7, 1942, regarding this installation of BC-348-H receivers.

RELAY, high voltage, SCB-324 for junction box, drawing No. 63-95009. Box assembly radio command set. Junction listed as SC-B-324-A. Substitution: 2Z5672.4/3 p/junction box TM-AH-172.

RELAYS: -

RELAY, ANTENNA, VACUUM (type No. 3926-E, ref No. 110F/412. Used with RA-10-DA receiver and TA-12 transmitter. Used to change antenna from receiving to transmitting and visa versa.)

Relay RE1 replaced by relay RE2.

Filament circuit revised, resistors R-36A, R-36B added.

Rheostat R6-1 replaced by R-37-1 and dropping resistors R8-1 and R8-2 replaced by R-35-1 and R-35-2.

Rheostat R6-2 replaced by R-27-2.

Resistors R8-3 and R8-4 replaced by R-35-3 and R-35-4.

SCR RADIO SETS: -

The SCR-269-C is interchangeable, component for component, with the SCR-269-A, and is identical except that the SCR-269-C has provision for aural reception of unmodulated radio frequency signals.

(Note: All "A" and "C" have been ordered changed to "G.") SCR-240 parts and 261 parts are interchangeable except for dynamotor and relays.

SCR-183 (SCR-283 are interchangeable except for relays and dynamotors).

SCR-287 (and 187 are interchangeable except for dynamotors and relays).

SCR-280 (uses same dynamotor as 242-C)

SCR-280 (uses same indicators as 242-C)

NOTE: BC-224-F and BC-348-H receivers and later models of each, use a VT-152 tube instead of a VT-48 tube that was used in earlier models.

All parts for the SCR-240 and 261 are interchangeable except those noted

below:

<u>Ref No.</u>	<u>SCR-240</u>	<u>Transmitter</u>	<u>SCR-261</u>	<u>Ref No.</u>
414	12v	High voltage dynamotor	24v	408
	FU-32	Fuse	FU-31	
64	100 ohm	Resistor	300 ohm	41
62	12v	Keying relay	24v	17
72-1				25-1
72-2	12v	Clutch relays	24v	25-2
73-2	12v	Channel selecting motor	24v	29-2
73-1	12v	Ant. tuning motor	24v	29-1
none		Filament series resistors	5.7 ohm	(64 (68
<u>Receiver</u>				
310	100 ohm	Ant. loop selector relay	400 ohm	313
311	100 ohm	Parallel trans. loop selector relay	400 ohm	314
312	.43 ohm	Band switch motor clutch	1.67 ohm	315
323	DM-22-A	Dynamotor	DM-23-A	325
324	12v	Band switch motor	24v	326

NOTE: FILAMENT CIRCUITS ARE WIRED DIFFERENTLY

SCR-282-() is the same as SCR-242-() but has the following changes:

Dynamotor DM-20 replaced by DM-30.

Motor MO-4 changed to MO-5.

INTERCHANGEABILITY OF INSTRUCTION BOOKS

For OPERATION only, not for requisitioning parts

BC-191-():

A

B

C Interchangeable with D and E.

D Interchangeable with C and E.

E Interchangeable with C and D.

BC-224-():

A Not interchangeable.

B Interchangeable with C and D.

C Interchangeable with B and D.

D Interchangeable with B and C.

E Interchangeable with G and H.

F Not interchangeable.

G Interchangeable with E and H.

H Interchangeable with E and G.

(F, G, and H above has low band)

BC-307-():

A

B

C Interchangeable with D and E.

D Interchangeable with C and E.

E Interchangeable with C and D.

BC-341-():

- A
- B Covered in I. B. for R.
- C Equipment does not exist.
- D Interchangeable with E, F, and G.
- E Interchangeable with D, F, and G.
- F Interchangeable with D, E, and G.
- G Interchangeable with E, F, and D.

BC-348-():

- A Equipment does not exist.
 - B Interchangeable with C.
 - C Interchangeable with B.
 - D Equipment does not exist.
 - E Interchangeable with M and P.
 - F Equipment does not exist.
 - G Not interchangeable.
 - H Interchangeable with K and L.
 - I Equipment does not exist.
 - J Interchangeable with N.
 - K Interchangeable with H and L.
 - L Interchangeable with H and K.
 - M Interchangeable with E and P.
 - N Interchangeable with J.
 - O Not interchangeable.
 - P Interchangeable with E and M.
- (H, I, J, K, L, M, N, O, and P has low band)

BC-357-():

B Covered in I. B. for RC-39-A.

C

C

E

F

G Interchangeable.

H

J

K

M

P

BC-375-():

A Equipment does not exist.

B Equipment does not exist.

C Interchangeable with D and E.

D Interchangeable with C and E.

E Interchangeable with C and D.

BC-376-(): Part of I-76.

I.B. Interchangeable for all models.

RC-19-A: Not interchangeable.

RC-26: Interchangeable.

RC-27: Interchangeable.

RC-34: Not interchangeable.

RC-35: Not interchangeable.

RC-39-A: } Same I.B. is
RC-43-A: } used for both.

RC-39-B: } Same I.B. is used for both, but
 } is not complete without I.B.
RC-43-B: } for the particular receiver used.

RC-73: Not interchangeable.

RC-103: Not interchangeable.

RC-139: Not interchangeable.

SCR-(A)-183:

AA Not interchangeable.

AB Not interchangeable.

AC Not interchangeable.

AD Not interchangeable.

AE Interchangeable with AG.

AF Not interchangeable.

AG Interchangeable with AE.

AH

AI

AJ

AK

AL Interchangeable.

AN

AO

AP

AR

SCR-187: Covered by I.B. for BC-191-()
And BC-224-().

SCR-211-():

- A
- B Interchangeable.
- C
- D Not interchangeable.
- E Interchangeable with N and AA.
- F Interchangeable with J, K, L, P, S, and T.
- G Interchangeable with M and AB.
- H Interchangeable with Q and U.
- J Interchangeable with F, K, L, P, S, and T.
- K Interchangeable with F, J, L, P, S, and T.
- L Interchangeable with F, J, K, P, S, and T.
- M Interchangeable with G and AB.
- N Interchangeable with E and AA.
- O Interchangeable with R and AC.
- P Interchangeable with F, J, K, L, P, and T.
- Q Interchangeable with U and H.
- R Interchangeable with O and AC.
- S Interchangeable with F, J, K, L, P, and T.
- T Interchangeable with F, J, K, L, P, and S.
- U Interchangeable with Q and H.
- AA Interchangeable with E and N.
- AB Interchangeable with M and G.
- AC Interchangeable with O and R.

SCR-238: Covered by I.B. for BC-307-()
and BC-224-().

SCR-240: Covered by I.B. as SCR-261.
Not interchangeable with any other.

SCR-241: Same instruction book used.

SCR-241-A: for both.

SCR-241-B: Not interchangeable.

SCR-242-():

- A Not interchangeable.
- B Same I.B. used for B and C.
- C Same I.B. used for B and C.

SCR-261: Covered by same I.B. as SCR-240.
Not interchangeable with any other.

SCR-269-():

- A Same I.B. for A and C.
- B Equipment does not exist.
- C Same I.B. for A and C.
- D Not interchangeable.
- E Equipment does not exist.
- F Not interchangeable.
- G I.B. for C can be used. I.B. for G should not be used with C.
SCR-269-G is same as C except for use of planes' C.C. for low voltage supply instead of selenium rectifier.

SCR-274-N: Not interchangeable with any
other I.B.

SCR-()-283:

- AA Through AK. No equipments exist.
- AL Interchangeable with N, O, Q, and R.

SCR-()-283: (contd)

AM Equipment does not exist.

AN Interchangeable with L, O, Q, P, and R.

AO Interchangeable with L, N, Q, P, and R.

AQ Interchangeable with L, N, O, and R.

AR Interchangeable with L, N, O, and R.

SCR-287: Covered by I.B. for BC-375
and BC-348.

SCR-515-A: Not interchangeable with
any other I.B.

SCR-517-():

A Not interchangeable.

B Not interchangeable.

C Not interchangeable.

SCR-518-A: Not interchangeable with
any other I.B.

SCR-520-():

A Not interchangeable.

B Not interchangeable.

SCR-521-():

A Not interchangeable.

B Not interchangeable.

SCR-522-A: Not interchangeable with
any other I.B.

SCR-535-():

T1 Not interchangeable.

A Same book is used for SCR-535-A
and SCR-535-AZ. AZ is the
AZ 12-volt equivalent of A.

SCR-540-():

A Not interchangeable.

B Not interchangeable.

SCR-578-A: Not interchangeable.

SCR-585-():

A Not interchangeable.

B Not interchangeable.

SCR-618-A: Not interchangeable with
any other I.B.

SCR-695-A: Not interchangeable.

SCR-717-():

A Not interchangeable.

B Not interchangeable.

C Not interchangeable.

NOTE: See AAF 08 series of Technical Orders for other instruction books.

TEST EQUIPMENT - AIRBORNE RADIO SETS

RESTRICTED

CLASSIFICATION	TEST EQUIPMENT	DEPOT	SERVICE COMPANY	SQUADRON	MODIFICATION CENTER	FACTORY	SCHOOL	STANDARDIZATION	USED WITH	CLASSIFICATION
R	● 1E-9-()	2	3	---	---	---	---	YES	GENERAL PURPOSE	R
R	1E-12-()	1	---	---	---	---	---	NO	SCR-622-()	R
C	1E-13-()	---	---	3-PER SQUADRON EQUIPPED	1	---	---	NO	SCR-621-()	C
R	1E-16-()	2	3	2-PER FIGHTER & BOMBER SQ. 1-ALL OTHER SQ. EQUIPPED	2	4	---	NO	SCR-530-()	C
R	1E-17-()	---	---	1-PER GLIDER SQUADRON WHEN ORGANIZED	---	2	---	YES	SCR-505-()	R
R	1E-18-()	2	1	3-PER FIGHTER SQUADRON 2-ALL OTHER SQ. EQUIPPED	2	4	---	NO	SCR-523-()	R
C	1E-21-()	2	1	3-PER SQUADRON EQUIPPED	1	---	---	NO	SCR-518-() SCR-519-()	C
R	1E-25-()	---	---	INACTIVE PENDING USE OF SCR-515-()				NO	SCR-515-()	C
R	1E-26-()	---	3	---	---	---	---	NO	GENERAL PURPOSE	R
R	1E-27-()	2	---	---	---	---	---	NO	GENERAL PURPOSE	R
C	1E-30-()	1	---	3-PER SQUADRON EQUIPPED	---	---	---	NO	SCR-517-()	C
R	1E-33-()	X	X	---	2	4	---	NO	RC-103-()	R
C	1E-34-()	2	3	---	1	2	---	NO	RC-24-()	C
R	1E-35-()	---	---	3-PER FIGHTER SQUADRON 2-PER ALL OTHER SQ. EQUIPPED	1	2	---	NO	SCR-274-H	R
C	1E-38-()	---	---	X	---	---	---	NO	SCR-518-()	C
S	1E-42-()	X	X	---	---	---	---	NO	SCR-622-()	S
C	1E-45-()	2	3	---	---	---	---	NO	SCR-526, 526, 526	C
R	1E-46-()	2	3	3-PER FIGHTER SQUADRON, 2-PER BOMBER SQUADRON 2-PER ALL OTHER SQ. EQUIPPED	2	4	---	NO	SCR-505-()	C
C	1E-48-()	2	3	---	---	---	---	NO	SCR-521-() SCR-540-()	C
C	1E-50-()	---	---	3-PER SQUADRON EQUIPPED	1	1	---	NO	SCR-540-()	C
S	1E-52-()	X	X	---	---	---	---	NO	SCR-722-()	S
R	▲ 1E-55-()	---	---	INACTIVE PENDING USE OF SCR-515-()				NO	SCR-515-()	C
S	1E-56-()	---	---	X	1	---	---	NO	SCR-729-()	S
C	■ 1E-57-()	1	---	3-PER SQUADRON EQUIPPED	2	---	---	NO	SCR 9-517 ()-520 () 717 ()-720 ()	C
C	1E-58-()	X	X	---	---	---	---	NO	SCR-517-()	C
R	± 1E-65-()	3	3	---	1	2	---	NO	SCR-274-H	R
R	○ 1E-68-()	1	---	---	---	---	---	NO	SCR-516-() SCR-516-()	C
R	RC-90-()	LIMITED DISTRIBUTION ONLY				---	---	---	SCR-290-()	R
R	RC-92-()	LIMITED DISTRIBUTION ONLY				---	---	---	SCR-261-()	R
R	RC-94-()	---	---	---	1	2	---	NO	SCR-274-H	R
R	RC-95-()	3	3	---	1	2	---	NO	SCR-274-H	R
R	1-56-()	1	2	4-PER FIGHTER CONTROL SQUADRON, 2-PER GROUND AIR SUPPORT COMMAND, 1-PER ALL OTHER AIR FORCE SQUADRON	2	2	---	YES	SCR 5-()-183, 187, 211, 226, 240, 242, 245, 261, 263, 275, 276, 280, 282, 283, 287, 575, 581, 5-15, 21, 24, 27, 36, 36, 61	R
R	1-72-()	3	3	---	---	---	---	YES	SCR 5-()-183, 187, 226, 240, 245, 263, 266, 273, 274-H, 276, 280, 282, 283, 287	R
R	1-76-()	2	1	1-PER AF SQUADRON EQUIPPED WITH RC-30-() OR RC-95-()	2	2	---	YES	SCR-241-() SC 5-20, 33, 33, 43 & 104	R
R	1-83-()	1	---	---	---	---	---	NO	SCR 5-() 183, 187, 226, 240, 261, 263, & 267	R
R	1-100-()	1	1	---	1	2	---	NO	SCR-290-()	R
R	1-103-()	---	---	1-PER SQUADRON EQUIPPED	---	3	---	NO	SCR-183-() SCR-283-()	R
R	+ 1-109-()	INACTIVE PENDING USE OF SCR-515-()				---	---	NO	SCR-515-()	C
R	1-173-()	2	3	3	2	4	---	NO	RC-103-()	R
C	1-184-()	---	---	X	1	2	---	NO	RC-24-()	C
R	A-55-()	X	X	---	---	3	---	NO	SCR-()-183 & ()-283	R
R	A-98-()	2	3	4-PER SQ. EQUIPPED	---	---	---	---	SCR-578-()	R
R	ME-21-()	2	---	---	---	---	---	YES	RC-96-()	R

- SUPERSEDED BY 1E-26-() & 1E-27-()
- ▲ SAME AS 1-109, BUT WITHOUT GAS-POWER UNIT PE-129-()
- SUPERSEDES 1E-30-() WHEN STOCK OF 74 IS EXHAUSTED
- ± SUPERSEDES RC-94-() & RC-95-()
- + SAME AS 1E-55-() WITH ADDITION OF GAS-POWER UNIT PE-129-()
- NONE
- X UNDETERMINED
- INACTIVE

APPROVED *Ray C. Stotts* APPROVED *W. E. Burns*
 RAY C. STOTTS
 1ST LIEUT. AIR CORPS
 PRODUCTION ENGR. SECTION
 MATERIEL CENTER

W. E. BURNS
 COL. SIGNAL CORPS
 SIGNAL OFFICER
 AIR SERVICE COMMAND

BASIC COMPONENTS

TEST EQUIPMENT - AIRBORNE RADIO SETS

January 1943

RESTRICTED

<p>IE-9(-) Used in T/BA for Signal Corps Repair Company. Used with but not part of Radio Repair Truck.</p>	<p>IE-30(-) Consists of: 1. Antenna Equipment RC-124-(-) 2. Cathode Ray Osc. BC-910-(-) 3. Test Unit BC-920-(-)</p>	<p>IE-56(-) Consists of: 1. Range Calibrator BC-949-(-) 2. Indicator BC-936-(-) 3. Frequency Meter BC-906-(-) 4. Receiver BC-1066-(-) 5. Signal Generator I-196-(-) 6. Cords CD-799 and CD-800</p>	<p>I-56(-) Universal radio test set. Consists of selective analyzer, tube checker, output meter, voltmeter multiplier, selector unit, volt-ohmmeter and adaptors.</p>
<p>IE-12(-) Consists of: 1. Dynamotor-28-Volt PE-94-(-) 2. Field Strength Meter I-95-(-) 3. Control box BC-602-(-) 4. Receiver BC-624-(-) 5. Transmitter BC-625-(-) 6. Signal Generator I-96-(-) 7. Crystal Units DC-11-(-)</p>	<p>IE-33(-) Provides for RF, IF and course alignment; permits checking of components by substitution method. Power supply from 115-Volt, 60 cps AC source.</p>	<p>IE-57(-) Universal Test Set Consists of: 1. Antenna Equipment RC-124-(-) 2. Cathode Ray Osc. BC-1087-(-) 3. Signal Generator BC-1077-(-) 4. Amplifier BC-1167-(-)</p>	<p>I-72(-) Signal Generator Range 100 KC to 31 MC.</p>
<p>IE-13(-) Consists of: 1. Range Calibrator BC-905-(-) 2. Frequency Meter BC-906-(-) 3. Recurrence Rate Meter I-143-(-) 4. Field Intensity Meter I-145-(-) 5. Voltmeter IS-185-(-) 6. Inverter Unit PE-115-(-) 7. Power Unit PE-143-(-) 8. Voltmeter IS-189-(-)</p>	<p>IE-34(-) Consists of: 1. Test I-174-(-) and various tubes and batteries.</p>	<p>IE-58(-) Consists of: 1. Test Bench--Western Elec. Co. Part #ES-687187-1 2. Test Bench--Western Elec. Co. Part #ES-687488-1 3. Test Unit--Western Elec. Co. Part #ES-XX687498 4. Probe Amplifier--Western Elec. Co. Part #D-150669 5. Cords</p>	<p>I-76(-) Consists of: 1. Test Oscillator BC-376-(-) 2. Test Indicator BE-67-(-) 3. Headset HS-23-(-)</p>
<p>IE-16(-) Consists of: 1. Receiver BC-650-(-) 2. Signal Generator I-98-(-)</p>	<p>IE-35(-) Consists of: 1. Antenna A-85-(-) 2. Test Unit I-155-(-) 3. Test Indicator I-106-(-)</p>	<p>IE-59(-) Consists of: 1. Signal Generator G. R. Co. Type 804-C 2. Modulator Unit DC-1203 3. 5" Cathode Ray, Oscilloscope RCA-Type 158 4. Diode Detector Coupling Head (SCR-595 & 695) BC-1201-(-) 5. Diode Detector Coupling Head (SCR-535) BC-1202-(-) 6. Two each Tube VT-90</p>	<p>I-83(-) Test Set for Dynamotors. Consists of primary voltage selector, 14-volt or 28-volt, meters for both input and output current and voltage, selector for input ammeter, input series rheostat and output load rheostat.</p>
<p>IE-17(-) Fort Monmouth Equip. Originally designed for use with Radio Set SCR-53c-(-).</p>	<p>IE-38(-) Consists of: 1. Test Unit I-165-(-) and various tubes.</p>	<p>IE-60(-) Consists of: 1. Antenna A-61-(-) 2. Antenna (Trans. Testing) A-68-(-) 3. Antenna (Rec'r. Testing) A-69-(-) 4. Test Unit I-104-(-) 5. Test Unit I-85-(-) 6. Test Unit I-155-(-) 7. Modulator Unit BC-456-(-) 8. Dynamotor DM-33-(-) 9. Control Box BC-938-(-) 10. Control Box BC-944-(-) 11. Crystal Units DC-30-(-) 12. Crystal Units one each six (6) freq. (Rec'r-one each four (4) freq.)</p>	<p>I-100(-) Test Set for Automatic Radio Compasses: Consists of: 1. Test Unit BC-713-(-) 2. Test Unit BC-714-(-) 3. Test Unit BC-715-(-) 4. Cords & Tubes</p>
<p>IE-19(-) Consists of: 1. Test Unit I-139-(-) 2. Field Strength Meter I-95-(-) 3. Signal Generator I-130-(-)</p>	<p>IE-42(-) Consists of: 1. Signal Generator I-194-(-) 2. Indicator BC-1174-(-) 3. Cable.</p>	<p>IE-61(-) Consists of: 1. Ammeter I-71-(-) 2. Antenna (Rec'r. Testing) A-59-(-) 3. Antenna (Trans. Testing) A-60-(-) 4. Dynamotor Unit PE-59-(-) 5. Headset HS-30-(-) 6. Loop LP-16-(-) 7. Control Box BC-226-(-) 8. Signal Generator I-72-(-) 9. Tuning Equip. IE-6-(-)</p>	<p>I-103(-) Meters for tuning Transmitters BC-(-) 230 & BC-(-) 430</p>
<p>IE-21(-) Consists of: 1. Test Unit I-161-(-) 2. Set of Tubes 3. Crystals</p>	<p>IE-45(-) Consists of: 1. Signal Generator G. R. Co. Type 804-C 2. Modulator Unit DC-1203 3. 5" Cathode Ray, Oscilloscope RCA-Type 158 4. Diode Detector Coupling Head (SCR-595 & 695) BC-1201-(-) 5. Diode Detector Coupling Head (SCR-535) BC-1202-(-) 6. Two each Tube VT-90</p>	<p>IE-62(-) Consists of: 1. Sweep Gen. RCA Model MI-18709-A 2. Signal Gen. RCA Model MI-18710-A 3. Output Meter RCA Model MI-18704 4. Diode Detector, RCA 5. Horiz. Def. Voltage Supply, RCA.</p>	<p>I-109(-) Consists of: 1. Power Unit PE-129-(-) 2. Signal Gen. BC-761-(-) 3. Test Unit I-86-(-) 4. Voltmeter IS-179-(-)</p>
<p>IE-25(-) Consists of: 1. Test Unit BC-763-T1 2. Power Unit PE-123-(-)</p>	<p>IE-46(-) Consists of: 1. Signal Generator I-196-(-) 2. Receiver BC-1066-(-) 3. Frequency Meter BC-906-(-)</p>	<p>RC-40(-) Consists of: 1. Ammeter I-71-(-) 2. Antenna (Rec'r. Testing) A-59-(-) 3. Antenna (Trans. Testing) A-60-(-) 4. Dynamotor Unit PE-59-(-) 5. Headset HS-30-(-) 6. Loop LP-16-(-) 7. Control Box BC-226-(-) 8. Signal Generator I-72-(-) 9. Tuning Equip. IE-6-(-)</p>	<p>I-173(-) Consists of: 1. Signal Generator, Vibrator Type 2. Antenna 3. Coils</p>
<p>IE-26(-) Consists of: 1. Vacuum Tube Voltmeter, Hickok #110 2. Wavemeter, General Radio #758-A 3. Oscilloscope-5" RCA #158-A 4. Signal Gen. General Radio 804-B 5. Test Set (Universal Radio) I-56-(-) 6. Test Set (Signal Gen.) I-72-(-) 7. Test Set (Marker Beacon) I-76-(-) 8. Test Set (Dynamotor) I-93-(-) 9. Audio Oscillator, Jackson #652 10. Frequency Meter SCR-211-(-) 11. Meter, RF. IS-70-(-) 12. Meter, RF. IS-73-(-) 13. Meter, RF. IS-76-(-) 14. Antenna, Dummy A-58-(-)</p>	<p>IE-48(-) Consists of: 1. Range Calibrator BC-905-(-) 2. Frequency Meter BC-906-(-) 3. Test Set I-143-(-) 4. Voltmeter IS-185-(-) 5. Voltmeter IS-189-(-) 6. Signal Gen. General Radio #804-B 7. Beat Freq. Osc. General Radio #700-A 8. Cathode Ray Osc-5"-RCA-158-A 9. Alternator-Type S-Small Motors Ltd., Canada 10. Repulsion-Induction Motor. 1 1/2 HP. single phase, 60c.p.s. 110-220 volts, 1750 RPM.</p>	<p>RC-42(-) Consists of: 1. Ammeter I-71-(-) 2. Antenna (Rec'r. Testing) A-59-(-) 3. Antenna (Trans. Testing) A-60-(-) 4. Dynamotor Unit PE-62-(-) 5. Headset HS-23-(-) 6. Loop LP-16-(-) 7. Control Box BC-351-(-) 8. Signal Generator I-72-(-) 9. Tuning Equip. IE-7-(-)</p>	<p>I-184(-) Consists of: 1. Cable WC-552-A (250 ft.) 2. Attenuator, Inductive, RF. RCA Type TX-1156</p>
<p>IE-27(-) Consists of: 1. Vacuum Tube Voltmeter, Hickok #110 2. Wavemeter, General Radio #758-A 3. Oscilloscope-5" RCA #158-A 4. Signal Gen. General Radio 804-B 5. Test Set (Universal Radio) I-56-(-) 6. Test Set (Signal Gen.) I-72-(-) 7. Test Set (Marker Beacon) I-76-(-) 8. Test Set (Dynamotor) I-93-(-) 9. Audio Oscillator, Jackson #652 10. Frequency Meter SCR-211-(-) 11. Meter, RF. IS-70-(-) 12. Meter, RF. IS-73-(-) 13. Meter, RF. IS-76-(-) 14. Antenna, Dummy A-58-(-) 17. Signal Generator, Ferris I8-C</p>	<p>IE-50(-) Consists of: 1. Frequency Meter BC-906-(-) 2. Test Set I-145-(-) 3. Inverter Unit PE-119-(-) 4. Power Unit PE-143-(-) 5. Voltmeter IS-185-(-) 6. Voltmeter IS-189-(-)</p>	<p>RC-44(-) Consists of: 1. Test Unit I-84-(-) 2. Headset HS-23-(-)</p>	<p>A-55(-) Phantom antenna 5 ohms, 100uuf, at frequency of 6200-7200 KC.</p>

* STANDARDIZED
NOT STANDARDIZED

EQUIPMENT CROSS REFERENCE CHART

(Listed by RC or SCR numbers showing only major components)

RC-32	BC-345, FL-5-A or FL-5-E, CD-316
RC-36	BC-347, BC-366, CD-307, PE-86-A
RC-39-A	BC-341-B, PL-108, FT-161, TM-187-A
RC-43-A	BC-357-B, PL-108, FT-161, TM-187-A
RC-45	BC-212-C, BC-366, CD-307-A
RC-51	BC-347, BC-213-B
RC-96	BC-608-A, BC-616
SCR-AJ-183	BC-AH-229, BC-AH-230, BC-AE-198
SCR-187-A	BC-224-F, BC-191-C, BC-77-D
SCR-211-A	BC-221-A, BC-81-A, DC-9-N
SCR-269-G	BC-433-G, BC-434-A, I-81-A
SCR-274-N	BC-453-A, 454, 455; B-457-A, 458, 459
SCR-280-A	BC-431-A, BC-432-B, I-65-D
SCR-287-A	BC-348-H, BC-375-C, PE-73-C
SCR-522-A	BC-624-A, BC-625, A, BC-602-A, PE-94-A
SCR-578-A	BC-778-A, GC-18-A, M276-A

NOTE: The SCR-AJ-183 radio set is used in this manual for illustrative purposes only. The SCR-AL-183 and later series (AN, AO, etc.) is now used. Physically the SCR-AJ-183 components look the same as the SCR-AL-183 series and later. See Signal Corps Stock Catalog for correct listing of component units.

NOTE: The SCR-()-283 radio set will be used in the new C-47 and the C-53 planes as they have a 28-volt supply.

PLANES USING VARIOUS EQUIPMENT

RC-32	A-20B, B-17-F, B-24, B-25, B-26, C-46, C-47, C-54, P-38, P-39, P-40, P-51
RC-36	B-17-F, C-46, C-54, B-24, B-25, B-26
RC-39-A	C-47
RC-43-A	B-17-F, B-24, B-25, B-26, C-46, C-54
RC-45	C-47
RC-51	A-20B
RC-96-A	P-38, P-39, P-40, P-51
SCR-AJ-183	C-47
SCR-187-A	C-47
SCR-211-N	B-17-F, B-24, B-25, B-26
SCR-269-G	B-17-F, B-24, B-25, B-26, C-46, C-54, C-47
SCR-274-N	A-20B, B-17-F, B-24, B-25, B-26, P-38, P-39, P-40, P-51, C-46, C-54, (See note below.)
SCR-280-A	C-47, (Early series.)
SCR-287-A	B-17-F, B-24, B-25, B-26, C-46, C-54
SCR-522-A	B-17-F, B-24, B-25, B-26, P-38, P-39, P-51 P-40, (See note below.)
SCR-578-A	B-17-F, B-24, B-25, B-26

NOTE: The P-38, P-39, P-40, and P-51 have installed either the SCR-274-N or the SCR-522-A but not both.

NOTE: In the future all new models of the C-47 and the C-53 will have 28-volt supply.

EQUIPMENT LIST PER PLANE

NOTE: The microphones listed below are part of one of the radio sets listed. They have been listed for quick reference.

A-20B: -

SCR-274-N Radio Set (Command)

RC-32 Filter Equipment

RC-51 Interphone Equipment

T-30 Microphone

B-17-F, B-24, B-25, B-26: -

SCR-211-N Frequency Meter

SCR-269-G Automatic Radio Compass

SCR-274-N Radio Set (Command)

SCR-287-A Radio Set (Liaison)

SCR-522-A Radio Set (VHF)

SCR-578-A Sea Rescue Transmitter

RC-32 Filter Equipment

RC-36 Interphone Equipment

RC-43-A Marker Beacon

T-30 Microphone

T-44 Microphone

P-38, P-39, P-40-E, P-51:

SCR-274-N Radio Set - Command - (or SCR-522-A Radio Set, VHF)

RC-32 Filter Equipment

RC-96-A Contactor Equipment

T-30 Mike (or T-44)

EQUIPMENT LIST PER PLANE
(Continued)

C-46, C-54: -

SCR-211-N Frequency Meter
SCR-269-G Automatic Radio Compass
SCR-274-N Radio Set (Command)
SCR-287-A Radio Set (Liaison)
SCR-578-A Sea Rescue Transmitter
RC-32 Filter Equipment
RC-36 Interphone Equipment
RC-43-A Marker Beacon
T-17 Microphone

C-47: -

SCR-211-N Frequency Meter
SCR-AJ-183 Radio Set (Command)
SCR-187-A Radio Set (Liaison)
SCR-269-G Automatic Radio Compass (or SCR-280 Radio Compass)
SCR-578-A Sea Rescue Transmitter
RC-32 Filter Equipment
RC-39-A Marker Beacon
RC-45 Interphone Equipment
T-17 Microphone

(In some cases the above list may vary.)

IMPORTANT NOTICE:

Sets of confidential or secret nature have not been listed in this publication but will be listed in a future supplement.

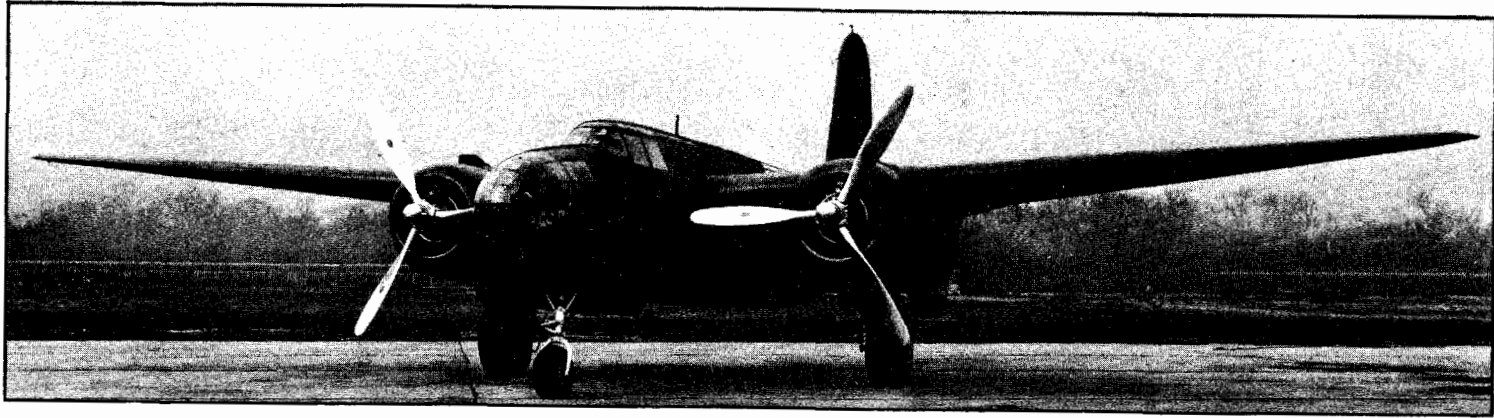

61'-4"

48'-0"

SCR-274-N Radio Set (Command)
RC-32 Filter Equipment
RC-51 Interphone Equipment
T-30 Microphone

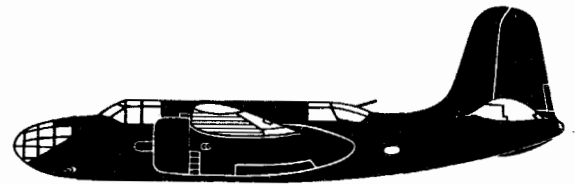

- 54 -

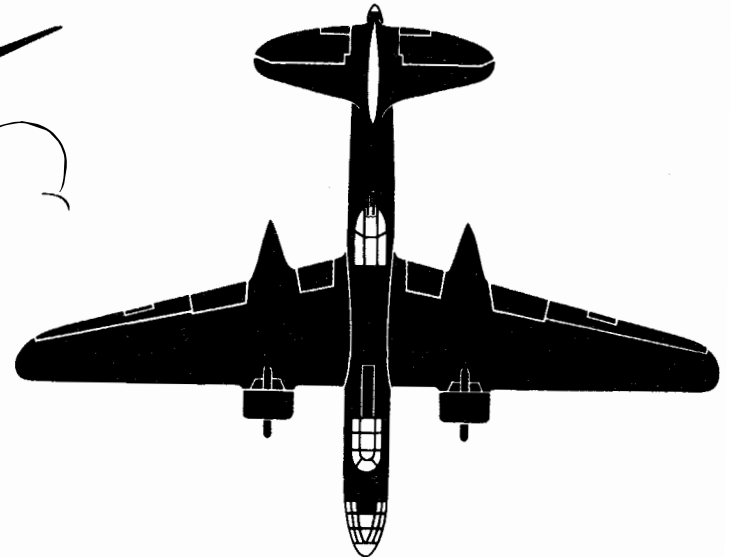
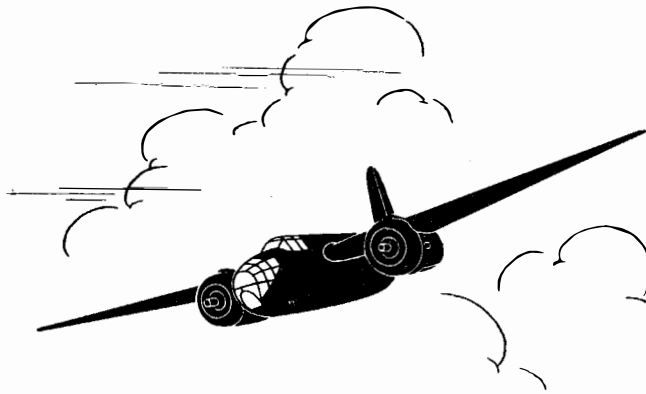
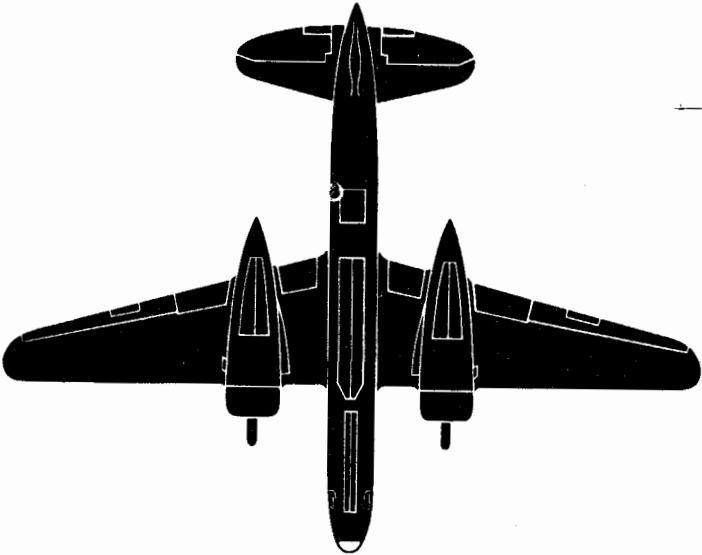

Douglas A-20

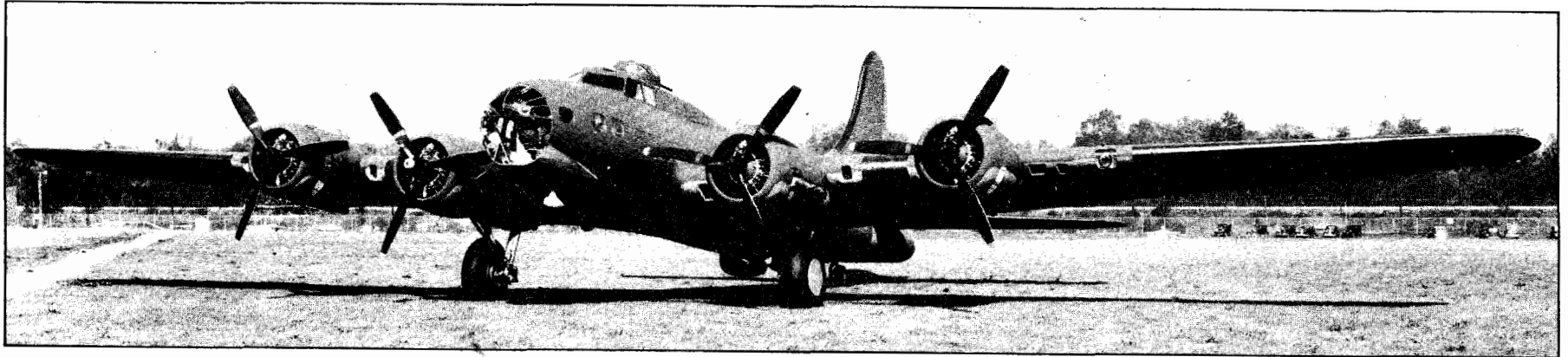

103'-10"

73'-10"



9ft

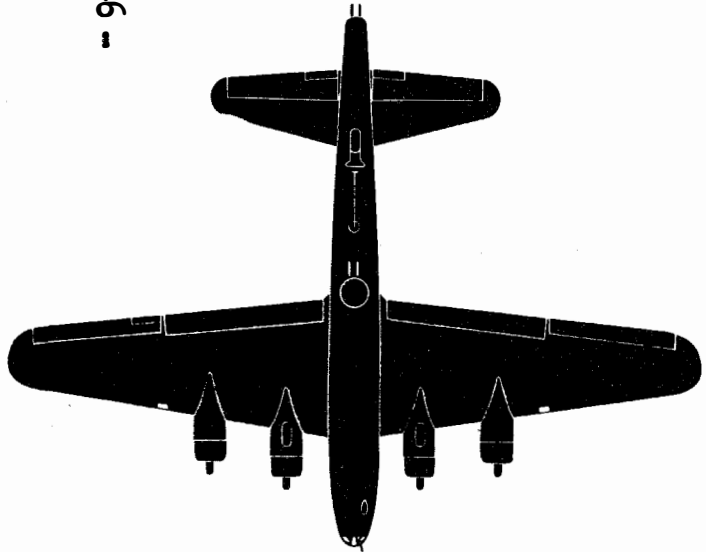

- SCR-211-N Frequency Meter
- SCR-269-G Automatic Radio Compass
- SCR-274-N Radio Set (Command)
- SCR-287-A Radio Set (Liaison)
- SCR-522-A Radio Set (VHF)
- SCR-578-A Sea Rescue Transmitter
- RC-32 Filter Equipment
- RC-36 Interphone Equipment
- RC-43 Marker Beacon
- T-30 Microphone
- T-44 Microphone

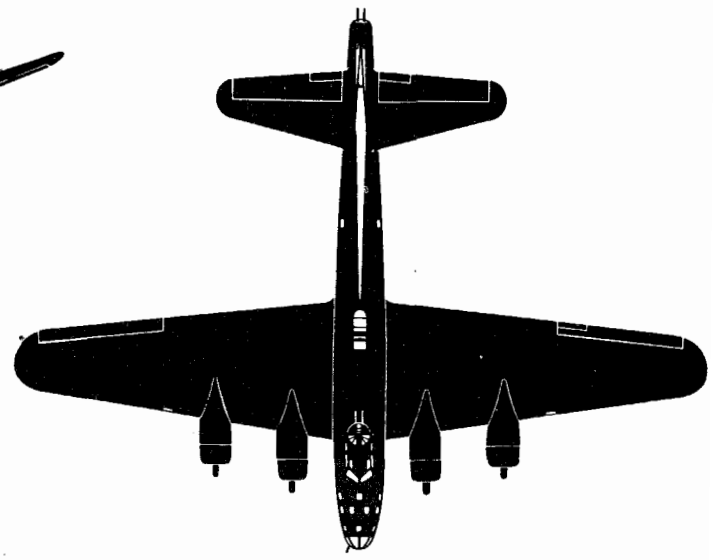
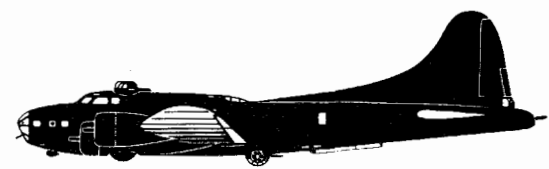

Boeing B-17

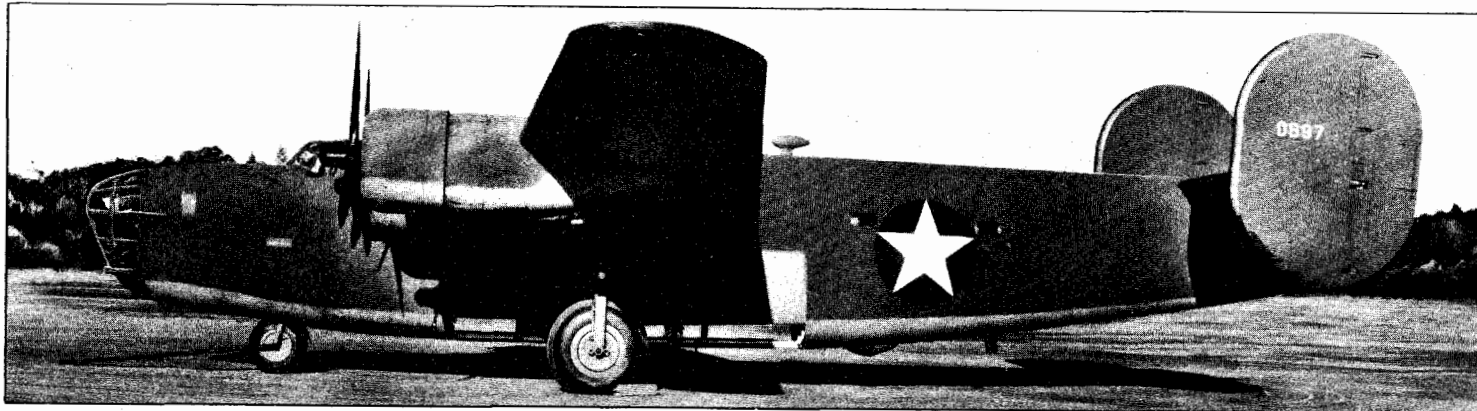

- SCR-211-N Frequency Meter
- SCR-269-G Automatic Radio Compass
- SCR-274-N Radio Set (Command)
- SCR-287-A Radio Set (Liaison)
- SCR-522-A Radio Set (VHF)
- SCR-578-A Sea Rescue Transmitter
- RC-32 Filter Equipment
- RC-36 Interphone Equipment
- RC-43 Marker Beacon
- T-30 Microphone
- T-44 Microphone

110'-0"



- 47 -

66'-0"

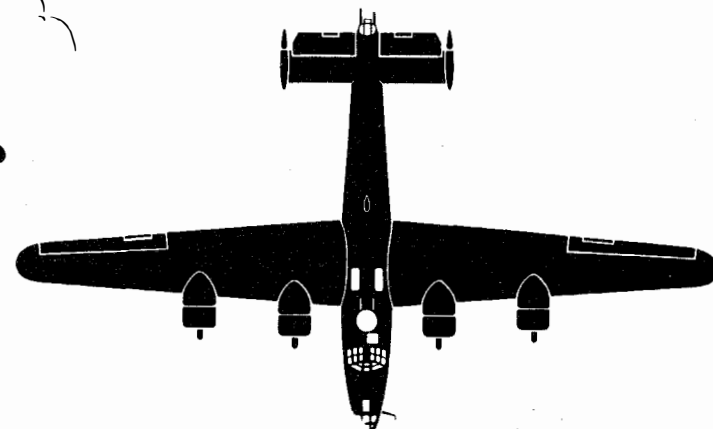
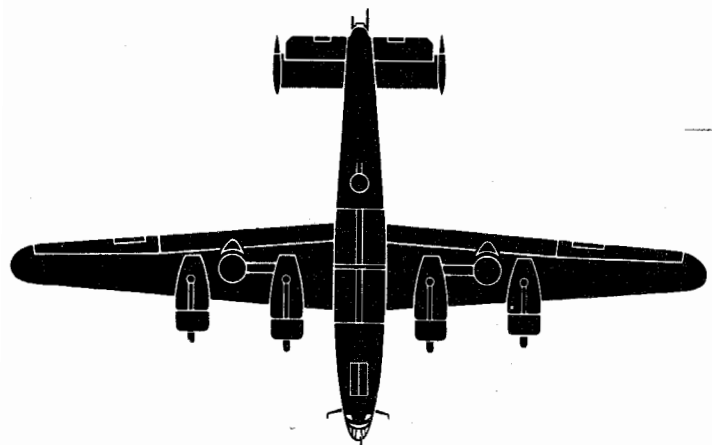
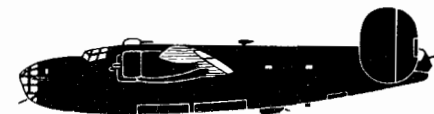

Consolidated B-24

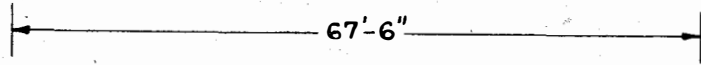
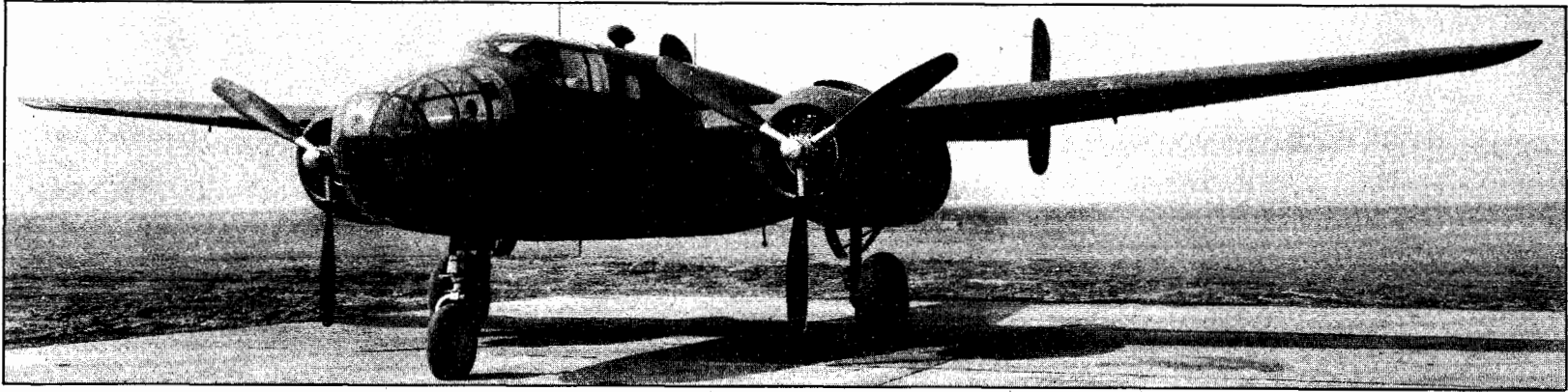

- 87 -

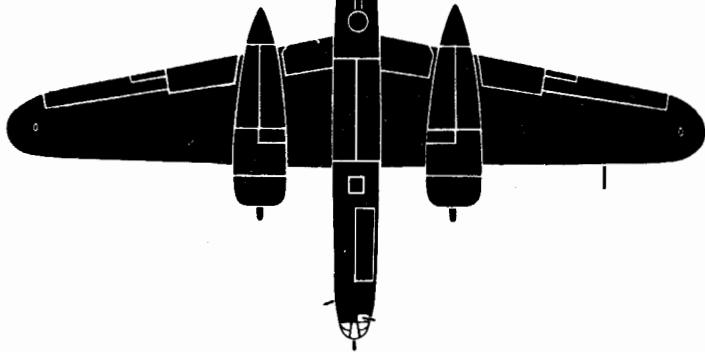

- SCR-211-N Frequency Meter
- SCR-269-G Automatic Radio Compass
- SCR-274-N Radio Set (Command)
- SCR-287-A Radio Set (Liaison)
- SCR-522-A Radio Set (VHF)
- SCR-587-A Sea Rescue Transmitter
- RC-32 Filter Equipment
- RC-36 Interphone Equipment
- RC-43 Marker Beacon
- T-30 Microphone
- T-44 Microphone

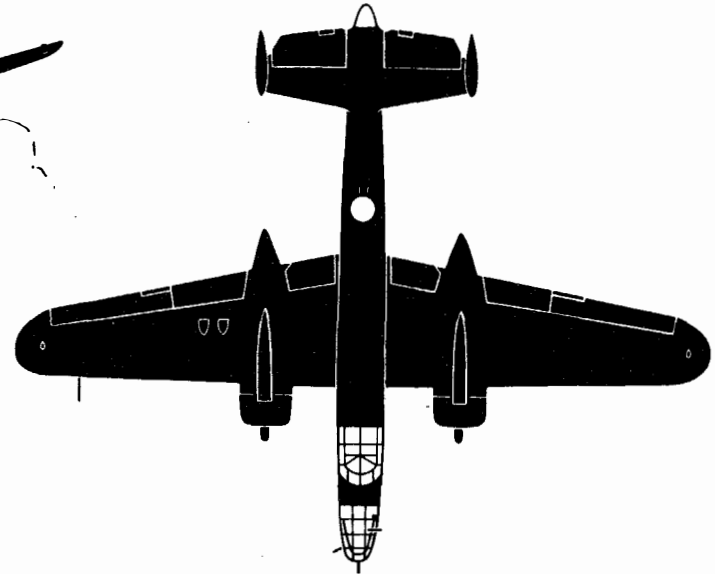
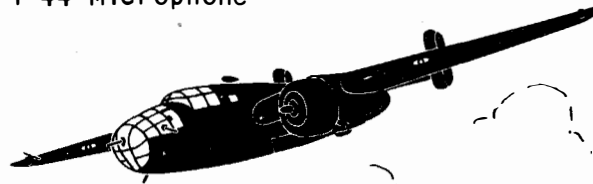
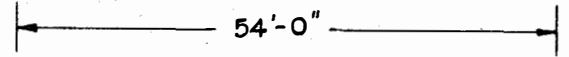

North American B-25

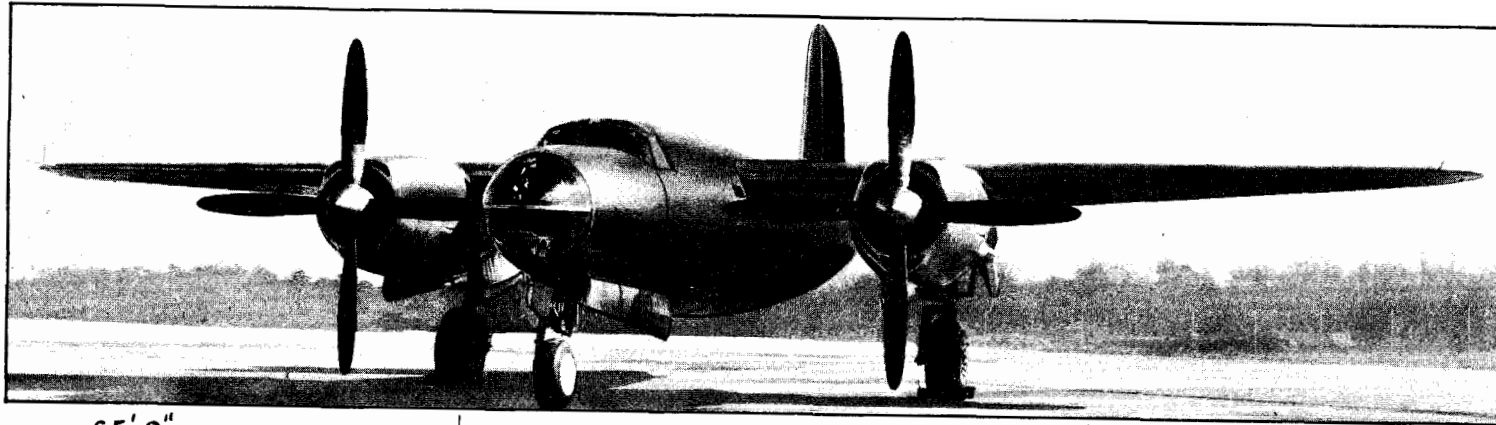

65'-0"



- 6ft -

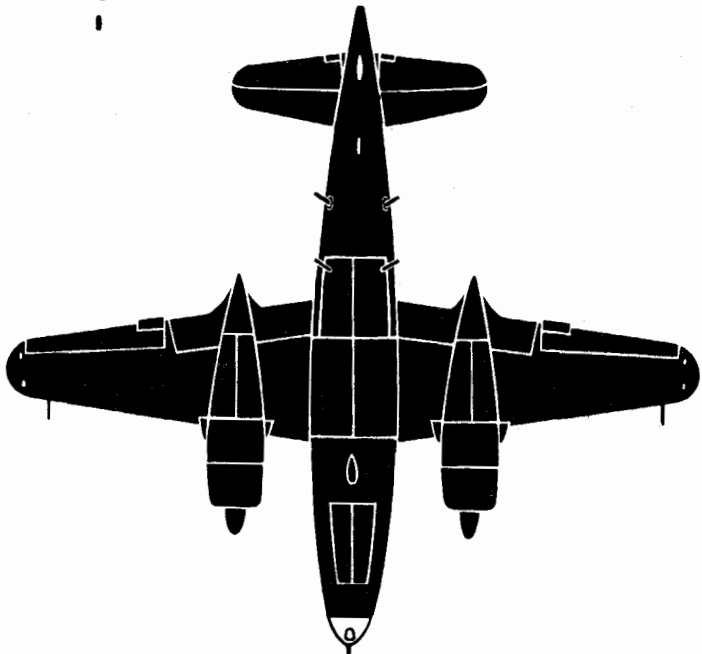

SCR-211-N Frequency Meter
SCR-269-G Automatic Radio Compass
SCR-274-N Radio Set (Command)
SCR-287-A Radio Set (Liaison)
SCR-522-A Radio Set (VHF)
SCR-578-A Sea Rescue Transmitter
RC-32 Filter Equipment
RC-36 Interphone Equipment
RC-43 Marker Beacon
T-30 Microphone
T-44 Microphone

58'-3"

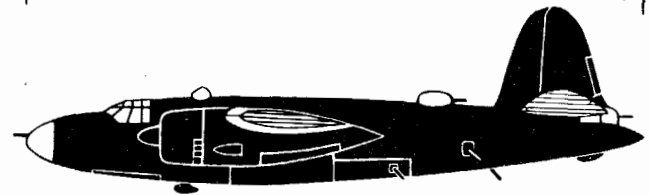

Martin B-26

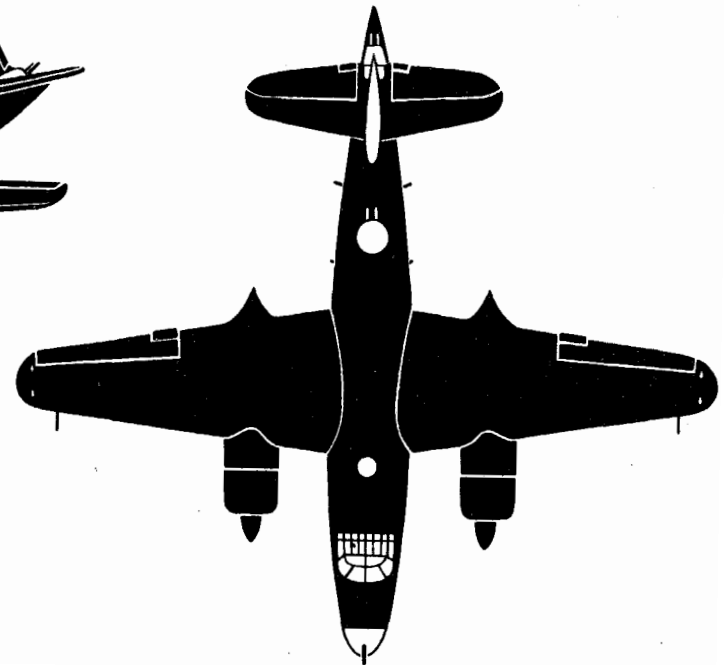

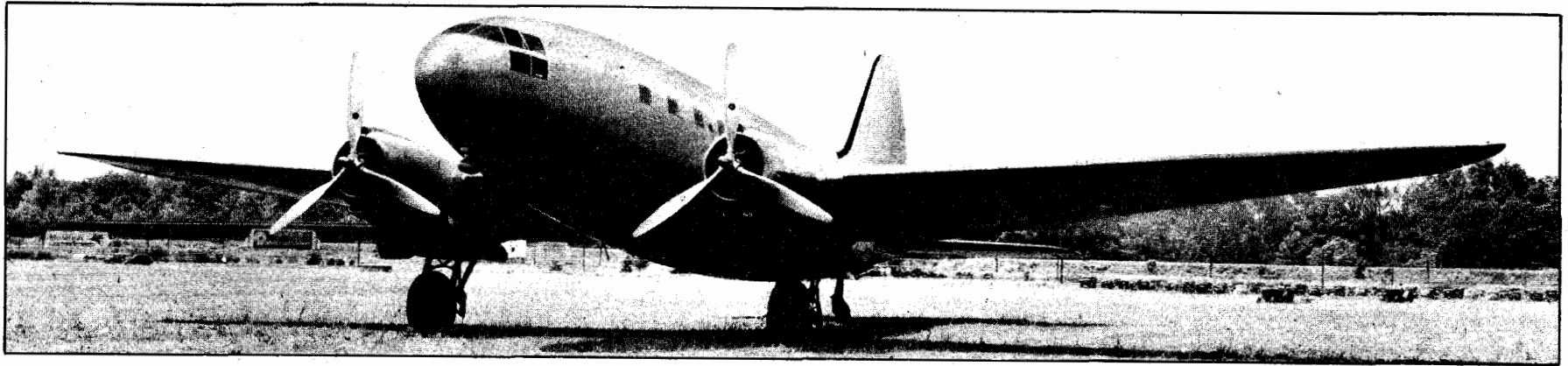

- SCR-211-N Frequency Meter
- SCR-269-G Automatic Radio Compass
- SCR-287-A Radio Set (Liaison)
- SCR-578-A Sea Rescue Transmitter
- RC-32 Filter Equipment
- RC-36 Interphone Equipment
- RC-43 Marker Beacon
- T-17 Microphone

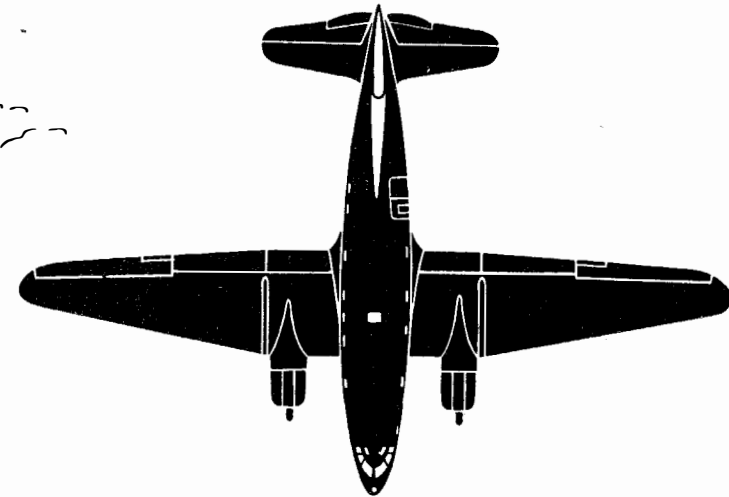
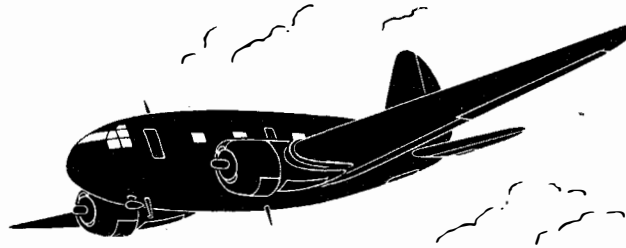
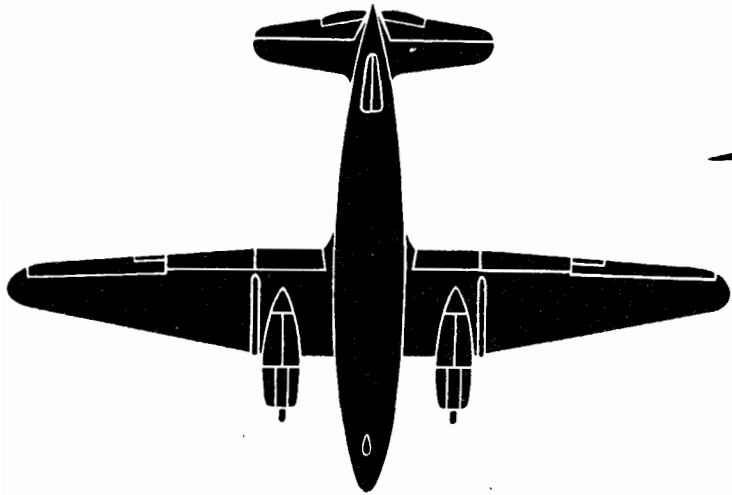
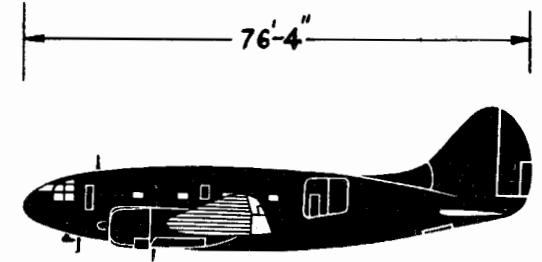
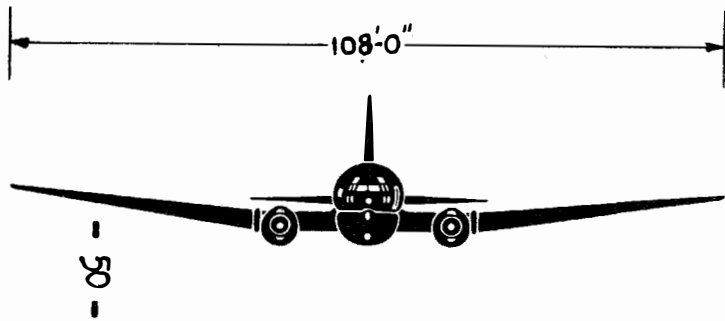

Curtiss C-46

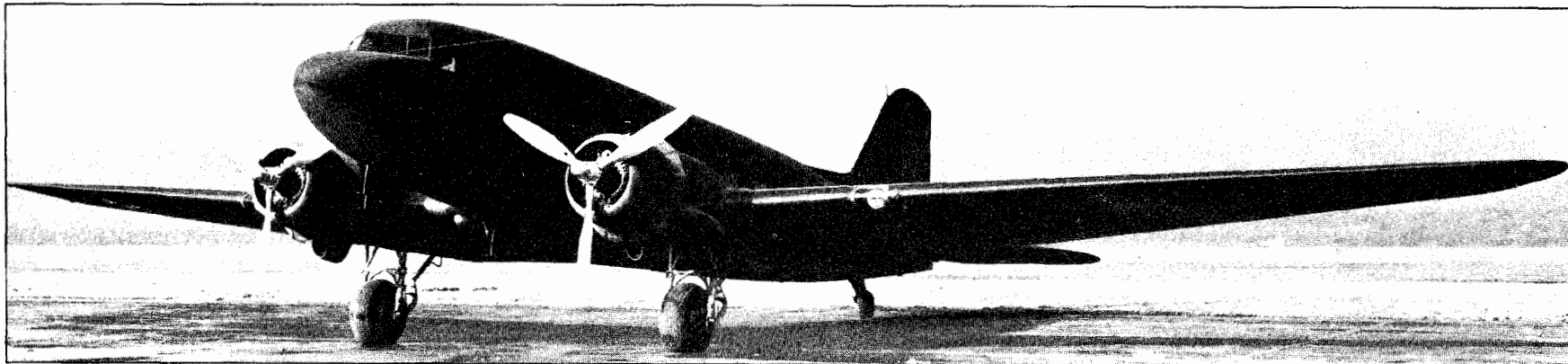

SCR-211-N Frequency Meter
 SCR-AJ-183 Radio Set (Command)
 SCR-187-A Radio Set (Liaison)
 SCR-265-G Automatic Radio Compass
 (or SCR-280 Radio Compass)
 SCR-578-A Sea Rescue Transmitter
 RC-32 Filter Equipment
 RC-39 Marker Beacon
 RC-45 Interphone Equipment
 T-17 Microphone

95'-0"

64'-6"

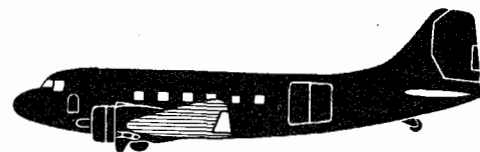

51'

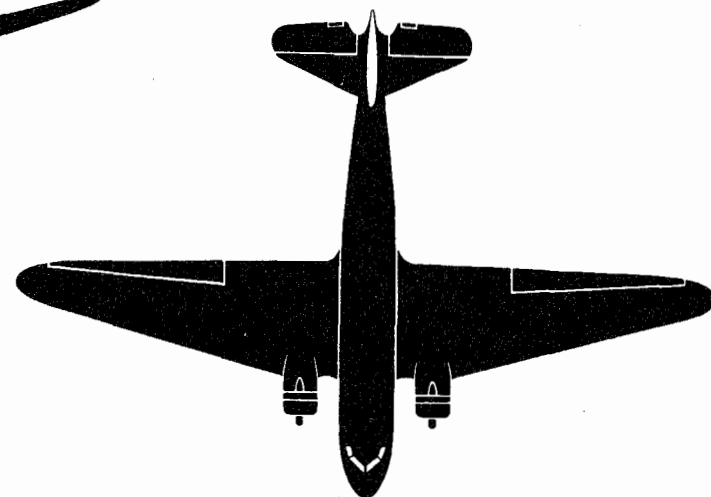
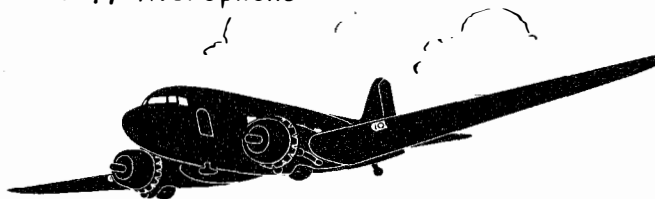
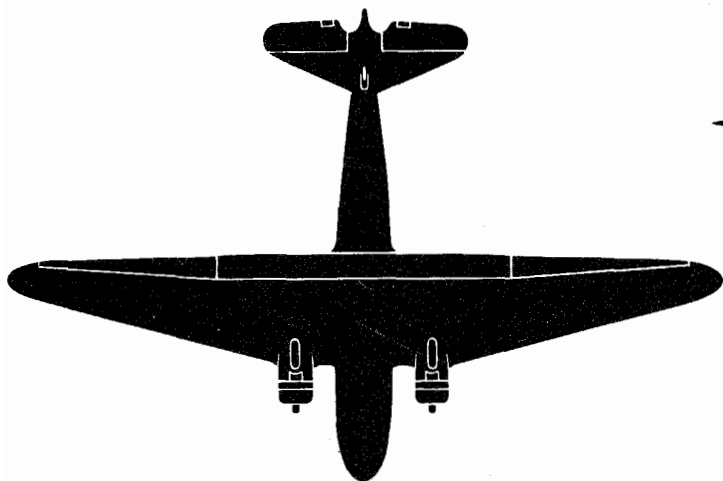

Douglas C-47

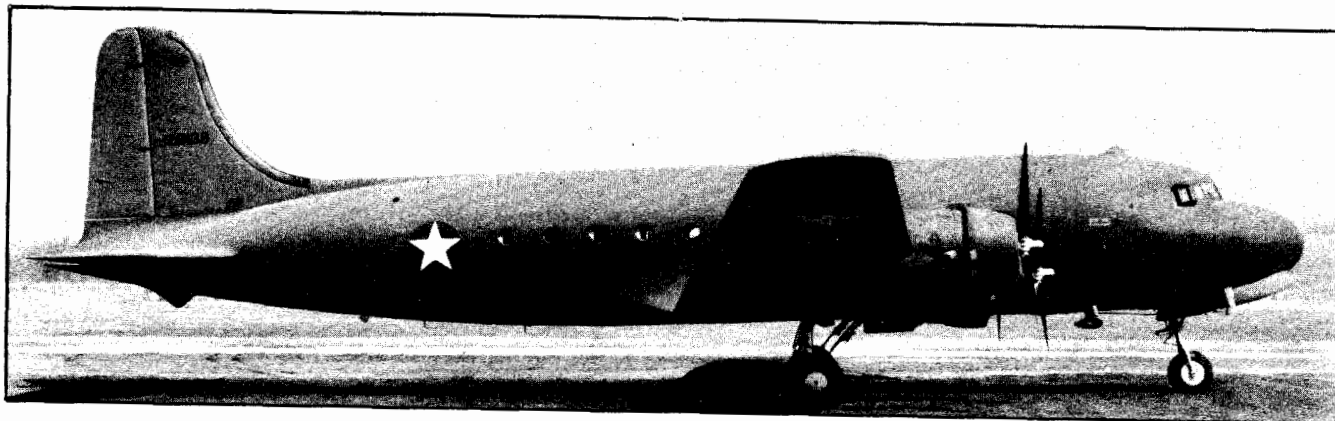

SCR-211-N Frequency Meter
SCR-269-G Automatic Radio Compass
SCR-287-A Radio Set (Liaison)
SCR-578-A Sea Rescue Transmitter
RC-32 Filter Equipment
RC-36 Interphone Equipment
RC-43 Marker Beacon
T-17 Microphone

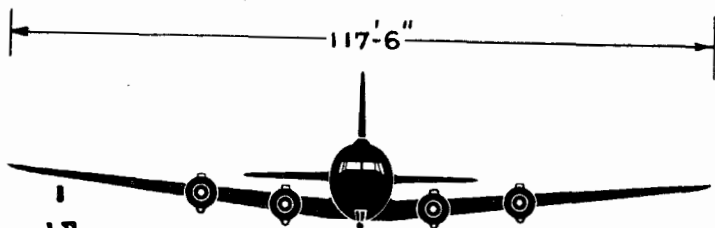

- 52 -

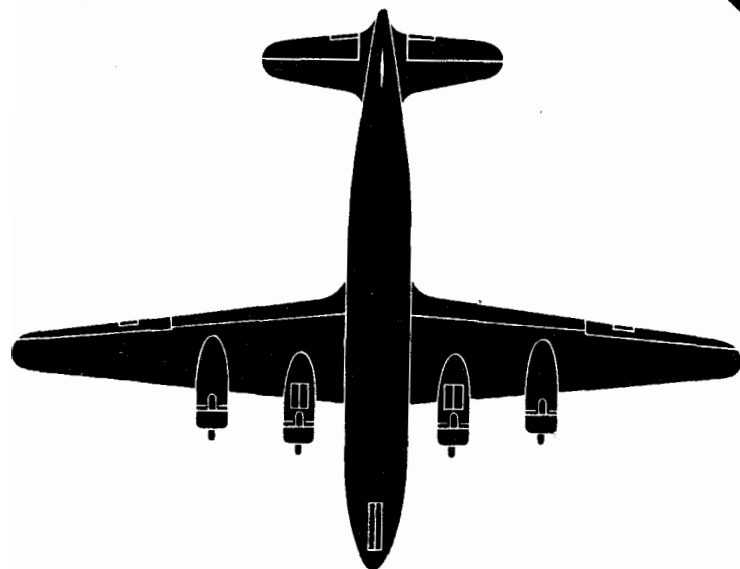
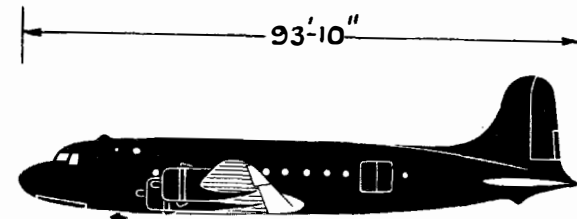

Douglas C-54

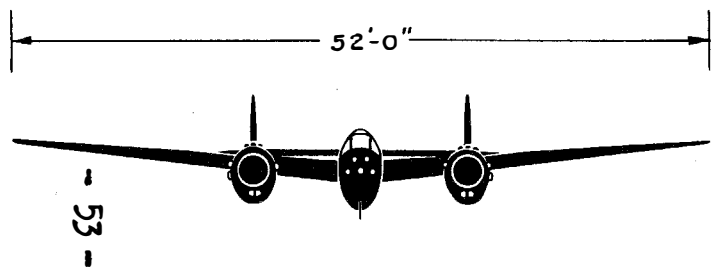
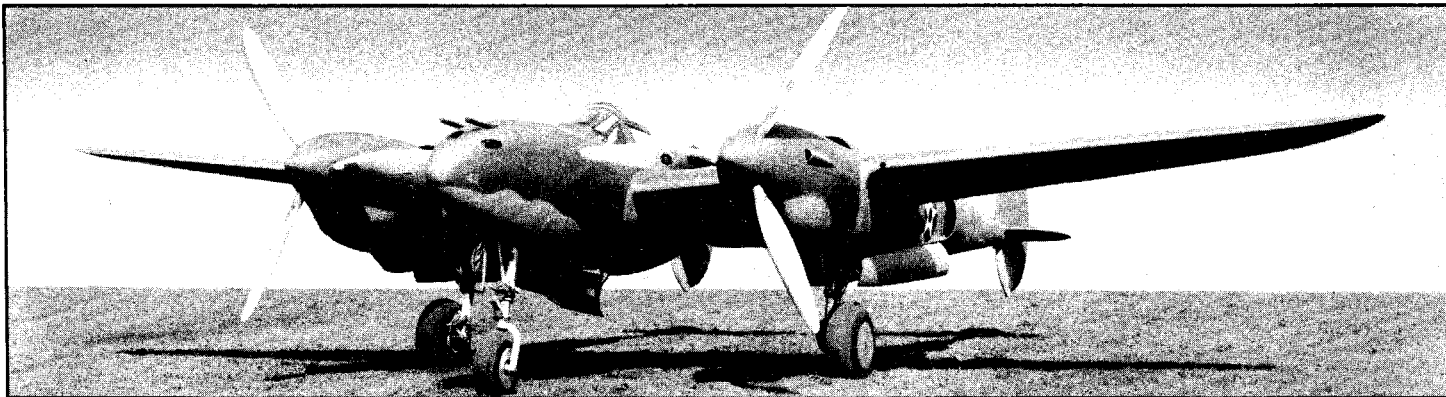

SCR-274-N Radio Set (Command)
(or SCR-522-A Radio Set, VHF)
RC-32 Filter Equipment
RC-96 Contactor Equipment
T-30 Microphone (or T-44)

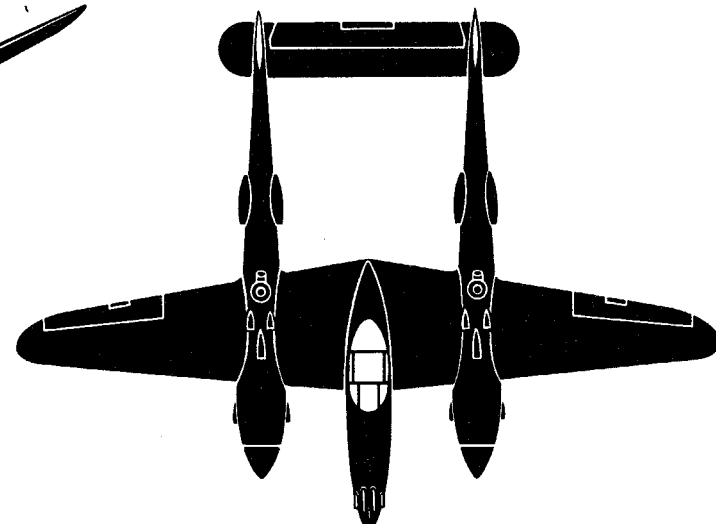
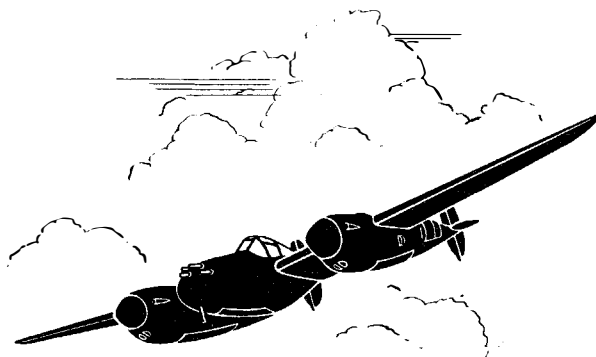
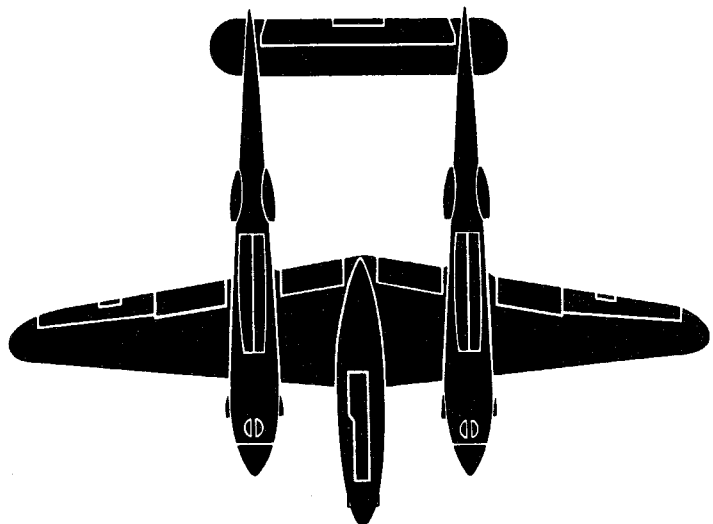
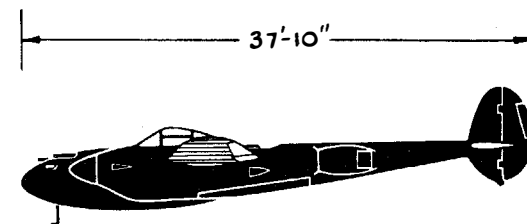

Lockheed P-38

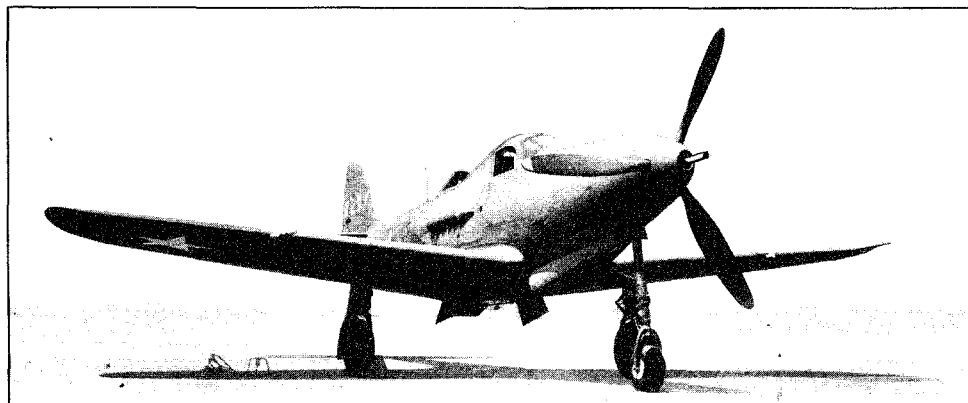

SCR-274-N Radio Set (Command)
(or SCR-522-A Radio Set, VHF)
RC-32 Filter Equipment
RC-96 Contactor Equipment
T-30 Microphone (or T-44)

34'-0"

30'-2"

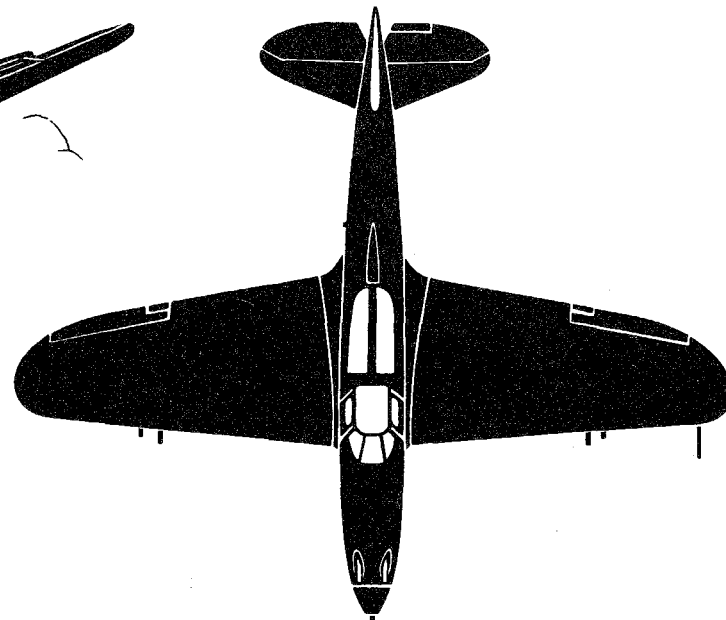
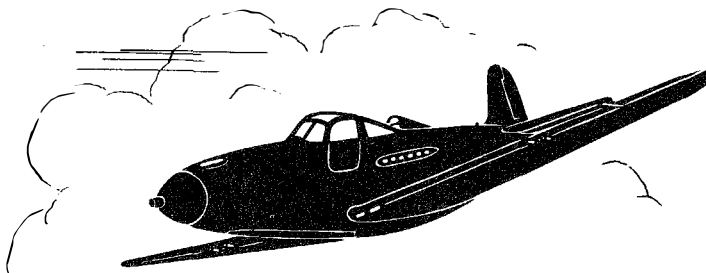
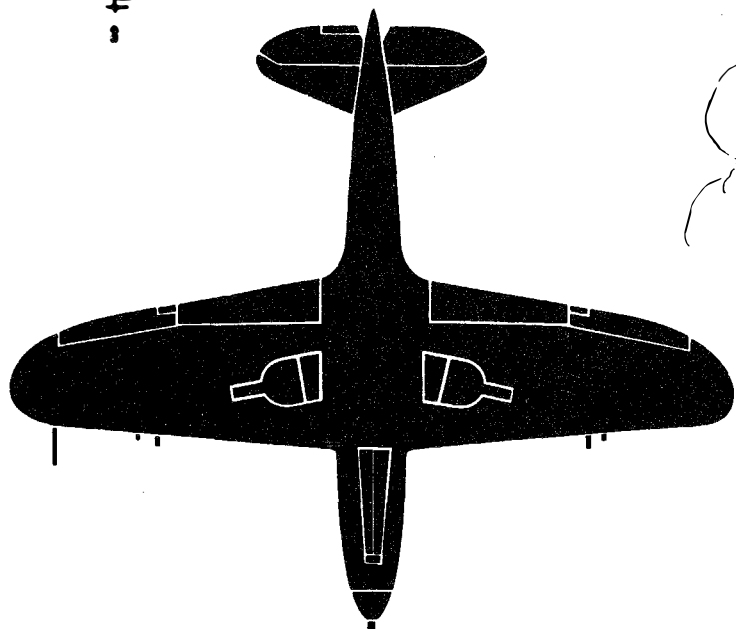
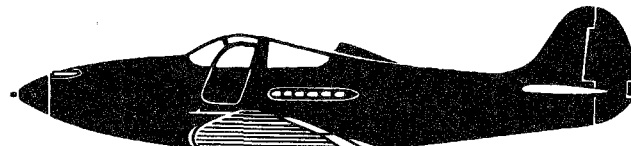

Bell P-39

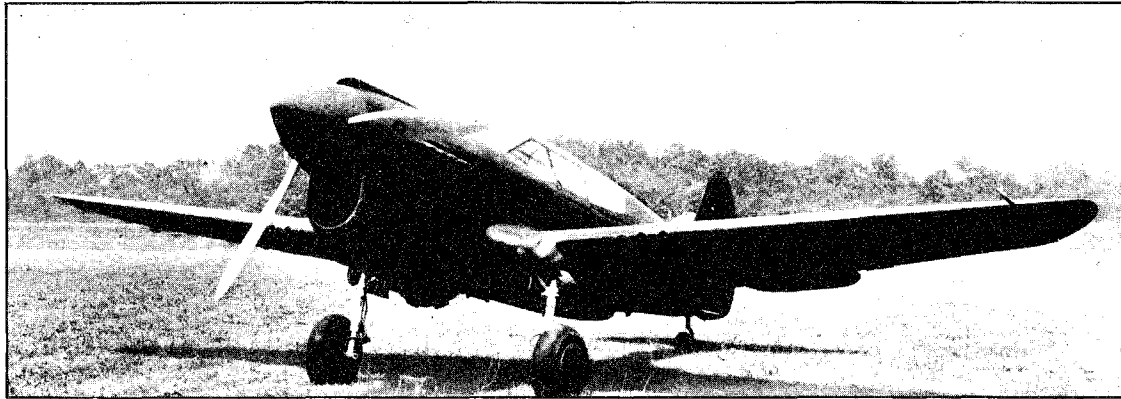

37'-4"



55

SCR-274-N Radio Set (Command)
(or SCR-522-A Radio Set, VHF)
RC-32 Filter Equipment
RC-96 Contactor Equipment
T-30 Microphone (or T-44)

31'-9"

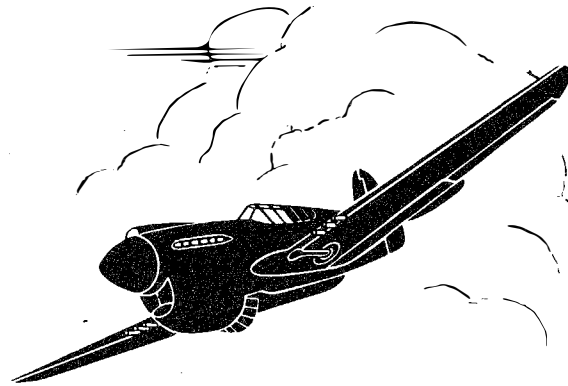
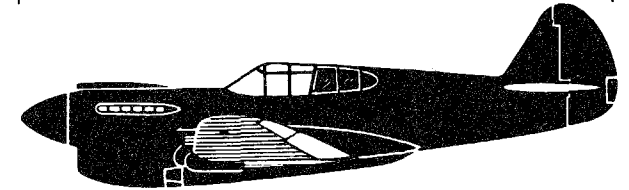

Curtiss P-40

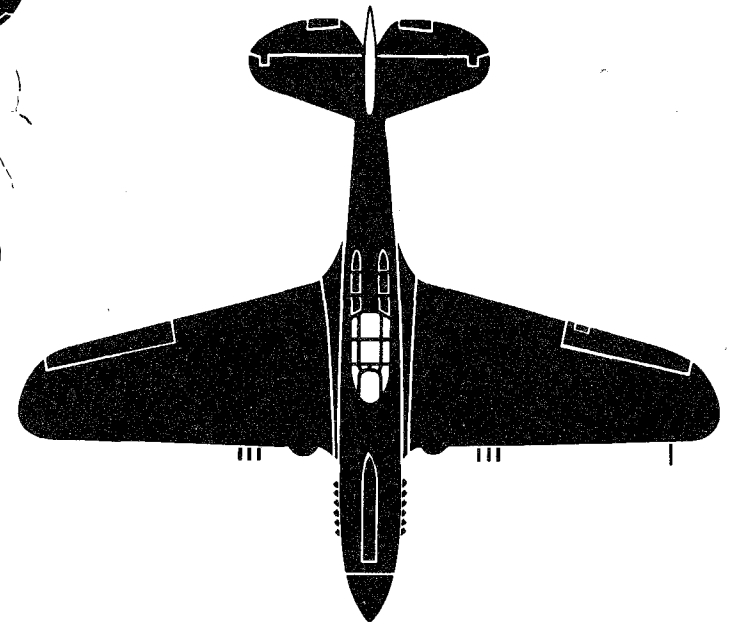

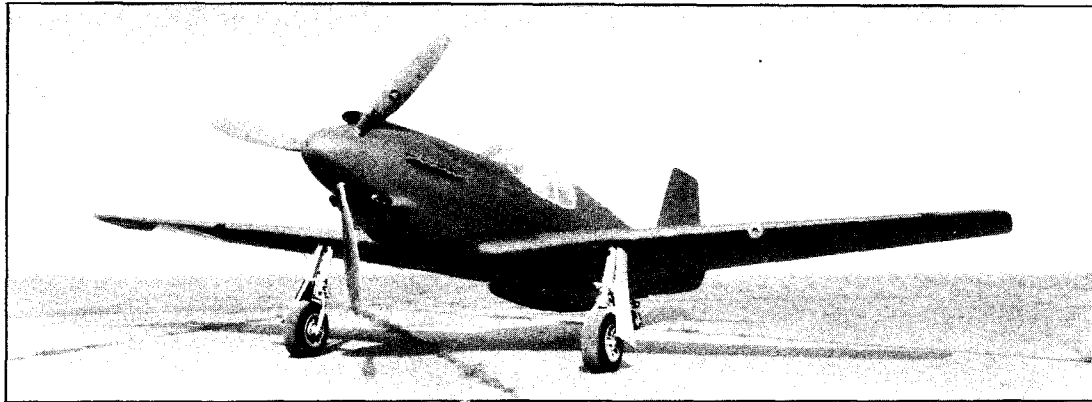

37'-0"

32'-3"

SCR-274-N Radio Set (Command)
(or SCR-522-A Radio Set, VHF)
RC-32 Filter Equipment
RC-96 Contactor Equipment
T-30 Microphone (or T-44)

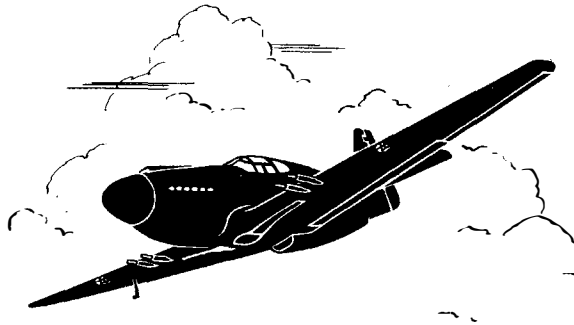
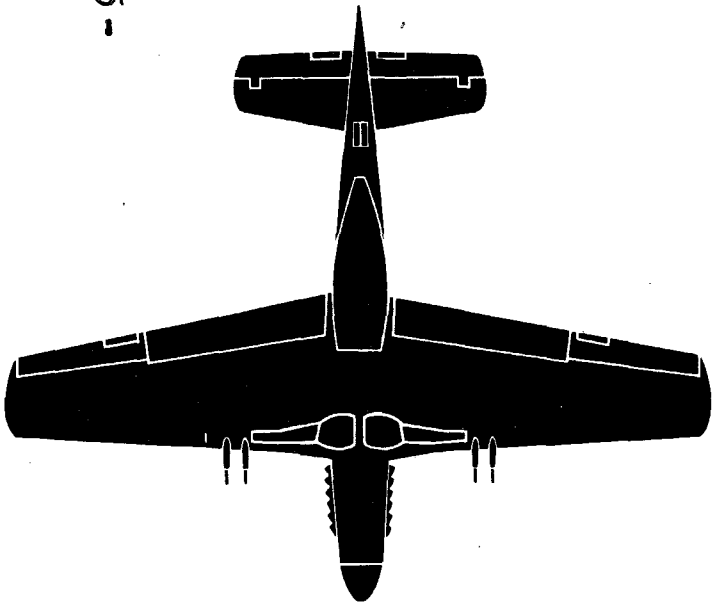
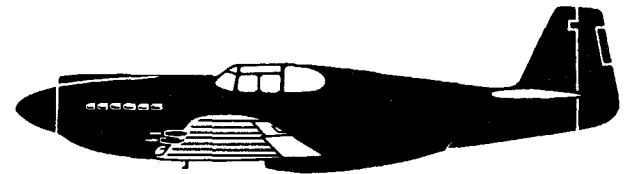
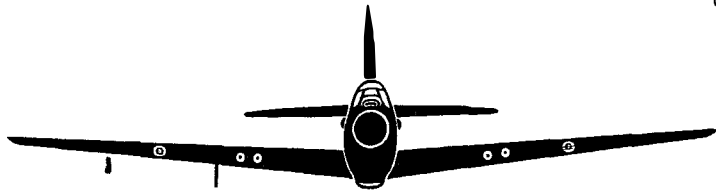

North American P-51

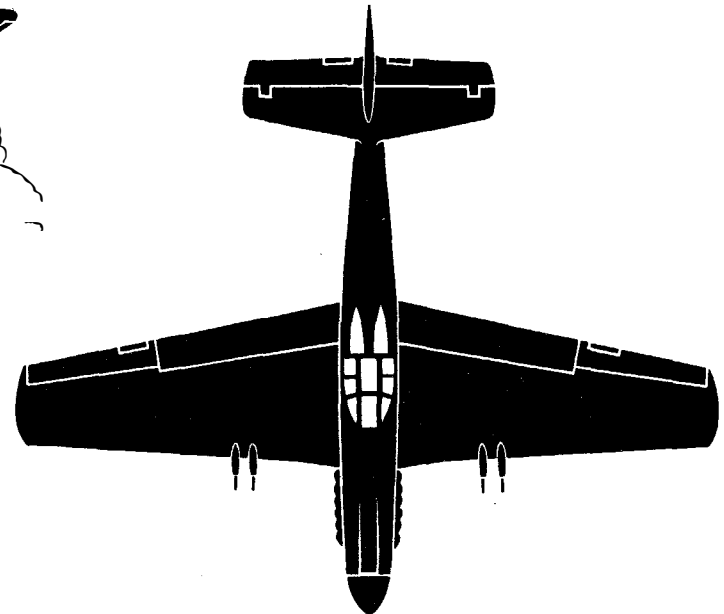

- 1- BC-213-B INTERPHONE JACK BOX (R)
- 2- BC-450-A RECEIVER CONTROL BOX (R)
- 3- BC-213-B INTERPHONE JACK BOX (R)
- 4- BC-451-A TRANSMITTER CONTROL BOX (R)
- 5- BC-345 FILTER SWITCH BOX (R)
- 6- FL-5-E FILTER (R)
- 7- BC-442-A ANTENNA RELAY (C)

- 8- BC-453-A
 - 9- BC-454-A
 - 10- BC-455-A
- RECEIVERS (C)

- 11- BC-457-A
 - 12- BC-458-A
- TRANSMITTERS (C)
- 13- BC-456-A MODULATOR UNIT (C)
 - 14- BC-347 INTERPHONE AMPLIFIER (C)
 - 15- BC-213-B INTERPHONE JACK BOX (R)
 - 16- ANTENNA

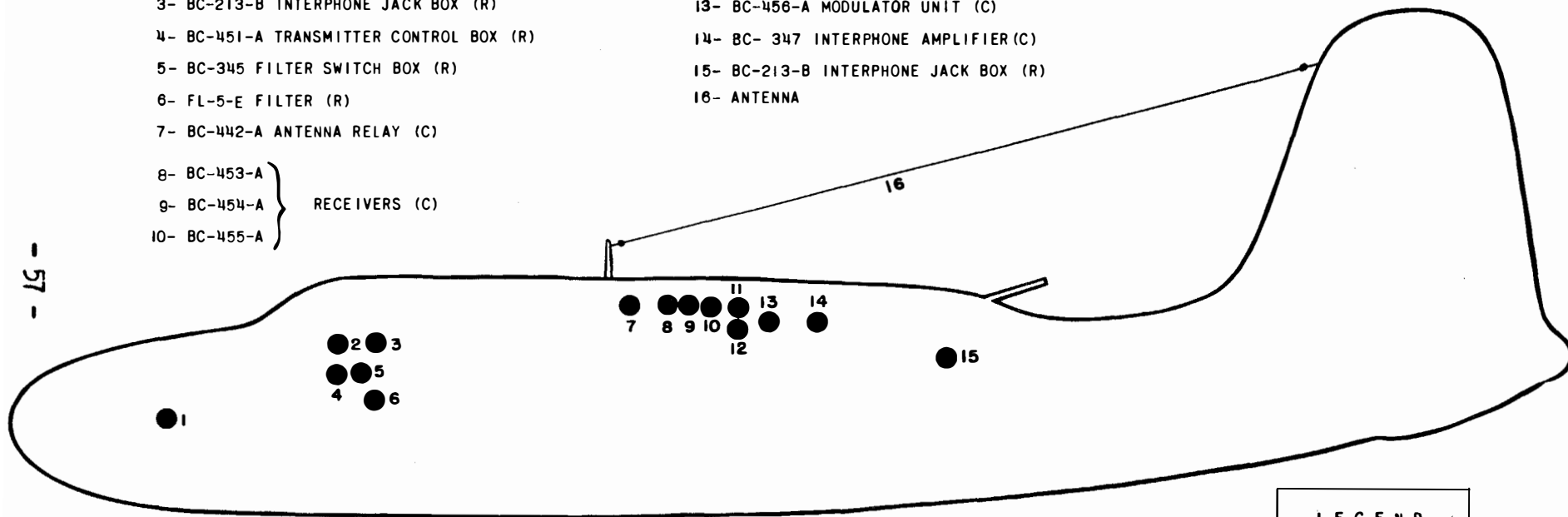

LEGEND	
R	Right
C	Center

DOUGLAS BOSTON....A-20

BOEING FLYING FORTRESS...B-17 F

- 1- V.H.F. RADIO CONTROL BOX BC-602-A
- 2- RADIO CONTROL BOX BC-434-A (T-CENTER)
- 3- COMMAND TRANSMITTER CONTROL BOX BC-451-A (T-CENTER)
- 4- COMMAND RECEIVER CONTROL BOX BC-450-A (T-CENTER)
- 5- SCR-535-A ANTENNA
- 6- ANTENNA RELAY UNIT BC-442-A (R)

- 7- COMMAND TRANSMITTERS BC-457-A & BC-458-A (R)
- 8- COMMAND RECEIVERS BC-453-A, BC-454-A, & BC-455-A (R)
- 9- IFF CONTROL BOX BC-648-A (L)
- 10- LIAISON RECEIVER BC-348-C (L)
- 11- LIAISON TRANSMITTER TUNING UNITS (EXTRA) (R)
- 12- LIAISON ANTENNA TUNING UNIT BC-306-A
- 13- VHF ANTENNA AN-74
- 14- COMMAND SET ANTENNA

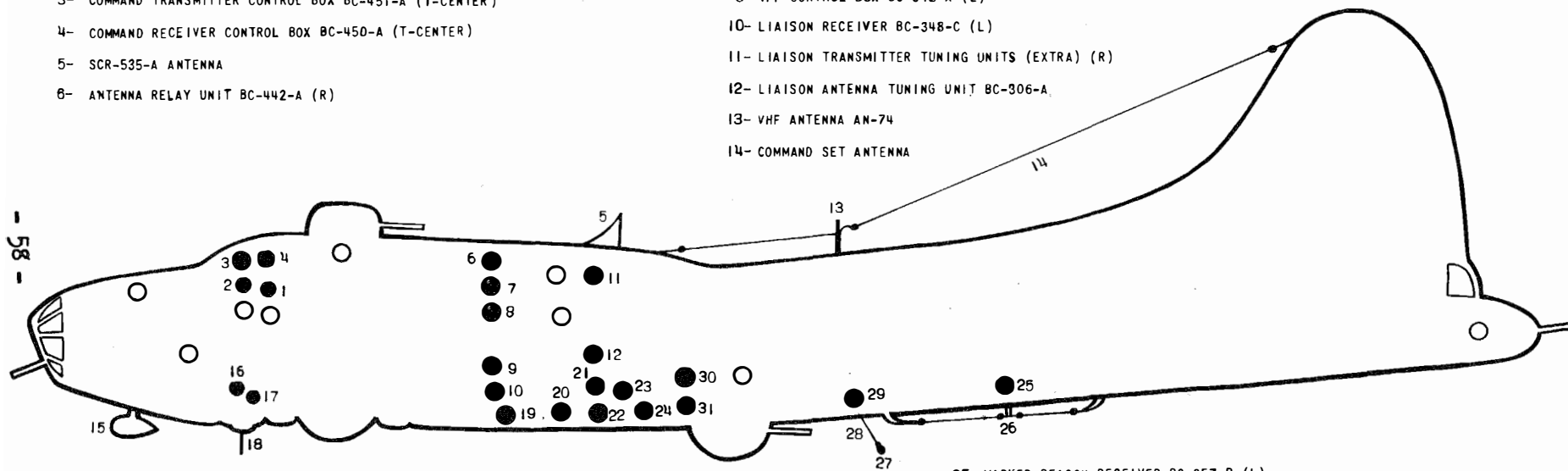

- 15- LOOP ANTENNA LP-21-A
- 16- RELAY UNIT BK-22-A
- 17- COMPASS RECEIVER BC-433-A
- 18- COMPASS ANTENNA
- 19- COMMAND SET MODULATOR UNIT BC-456-A (R)
- 20- FREQUENCY METER SCR-211-M (L)
- 21- LIAISON TRANSMITTER BC-375-C (R)
- 22- LIAISON TRANSMITTER TUNING UNIT (EXTRA) (L)
- 23- IFF RECEIVER BC-647-A (L)
- 24- LIAISON DYNAMOTOR UNIT PE-73-B (L)

- 25- MARKER BEACON RECEIVER BC-357-B (L)
- 26- MARKER BEACON ANTENNA
- 27- WEIGHT
- 28- LIAISON ANTENNA
- 29- REEL RL-42-A OR RL-30-B (L)
- 30- VHF TRANSMITTER RECEIVER (BC-624-A & BC-625-A) (L)
- 31- VHF DYNAMOTOR UNIT PE-94-A (L)

LEGEND
T — Top or Overhead
R — Right
L — Left
○ — RC-36 Interphone Equip. Stations

- 1- RECEIVER CONTROL BOX BC-450-A (T)
- 2- RADIO COMPASS CONTROL BOX BC-434-A (T)
- 3- PILOT'S RADIO BEARING INDICATOR I-81-A (C)
- 4- TRANSMITTER CONTROL BOX BC-451-A (C)
- 5- VHF RADIO CONTROL BOX BC-602-A (C)
- 6- RADIO BEARING INDICATOR (NAVIGATOR) I-82-A (C)
- 7- RADIO COMPASS CONTROL BOX BC-434-A (C)
- 8- FILTER SWITCH BOX EC-345 (L)
- 9- FILTER SWITCH BOX BC-345 (R)
- 10- INTERPHONE AMPLIFIER BC-347 (R)

- 11- {FL-5-E FILTERS (C)
- 12- {
- 13- REEL CONTROL BOX BC-461 (R)
- 14- LIAISON RADIO RECEIVER BC-348-H (R)
- 15- LIAISON RADIO TRANSMITTER BC-375-C (R)
- 16- LIAISON DYNAMOTOR PE-73-B (R)
- 17- AUTOMATIC REEL RL-42-A (R)
- 18- {
- 19- {EXTRA TUNING UNITS (R & T)

- 20- ANTENNA TUNING UNIT BC-308-A (R)
- 21- ANTENNA RELAY UNIT BC-442-A (T)
- 22- RADIO RECEIVERS { BC-453-A } (T-C)
 { BC-454-A }
 { BC-455-A }
- 23- RADIO TRANSMITTERS { BC-457-A } (T-C)
 { BC-458-A }

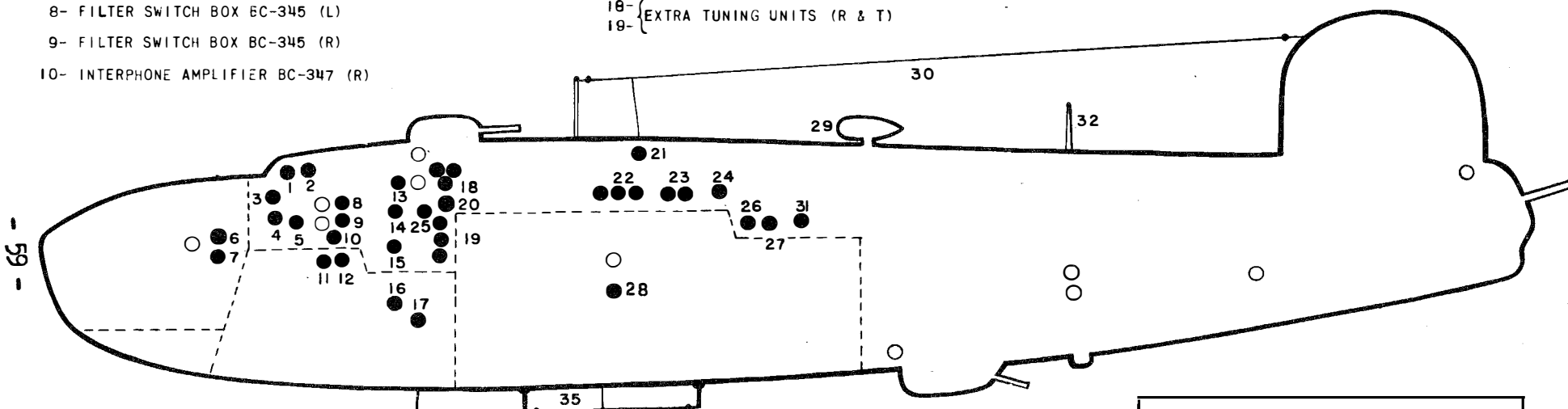

- 24- RADIO COMPASS UNIT BC-433-G (T-R)
- 25- INTERPHONE DYNAMOTOR PE-86-A (R)
- 26- MODULATOR UNIT BC-456-A (R)
- 27- VHF DYNAMOTOR UNIT PE-94-A (R)
- 28- MARKER BEACON RECEIVER (L)
- 29- LOOP LP-21-A
- 30- COMMAND SET ANTENNA

- 31- VHF TRANSMITTER RECEIVERS { BC-824-A } (R)
 { BC-625-A }
- 32- VHF RADIO ANTENNA
- 33- LIAISON RADIO SET ANTENNA
- 34- WEIGHT WT-7-A
- 35- MARKER BEACON ANTENNA

LEGEND	
○	BC-366 INTERPHONE JACK BOXES
T	TOP
C	CENTER
R	RIGHT
L	LEFT

CONSOLIDATED LIBERATOR...B-24

- 1- RADIO BEARING INDICATOR (PILOT) I-81-A (C)
- 2- FILTER SWITCH BOX BC-345 (R)
- 3- RECEIVER CONTROL BOX BC-450-A (R)
- 4- TRANSMITTER CONTROL BOX BC-451-A (R)
- 5- FILTER UNIT FL-5-E (R)
- 6- RADIO COMPASS CONTROL BOX BC-434-A (L)
- 7- FILTER SWITCH BOX BC-345 (L)
- 8- VHF RADIO CONTROL BOX BC-602-A (L)
- 9- MARKER BEACON RECEIVER BC-357-B (L)
- 10- RADIO COMPASS CONTROL BOX BC-434-A (L)

- 11- ANTENNA RELAY UNIT BC-442-A (R)
- 12- COMMAND RADIO RECEIVERS $\left\{ \begin{array}{l} BC-453-A \\ BC-454-A \\ BC-455-A \end{array} \right\}$ (R)
- 13- COMMAND TRANSMITTERS $\left\{ \begin{array}{l} BC-457-A \\ BC-458-A \end{array} \right\}$ (R)
- 14- MODULATOR UNIT BC-456-A (R)
- 15- RADIO COMPASS UNIT BC-433-A (L)
- 16- VHF RECEIVER TRANSMITTERS $\left\{ \begin{array}{l} BC-624-A \\ BC-625-A \end{array} \right\}$ (R)
- 17- EXTRA TRANSMITTER TUNING UNIT (R)

- 18- FREQUENCY METER SCR-211 (R)
- 19- LIAISON TRANSMITTER BC-375-C (L)
- 20- EXTRA TRANSMITTER TUNING UNITS (L)
- 21- INTERPHONE DYNAMOTOR PE-86-A (R)
- 22- LIAISON DYNAMOTOR UNIT PE-73-C (L)
- 23- LIAISON RECEIVER BC-348-H (L)
- 24- REEL CONTROL BOX RL-42-A (L)
- 25- VHF DYNAMOTOR UNIT PE-94-A (L)

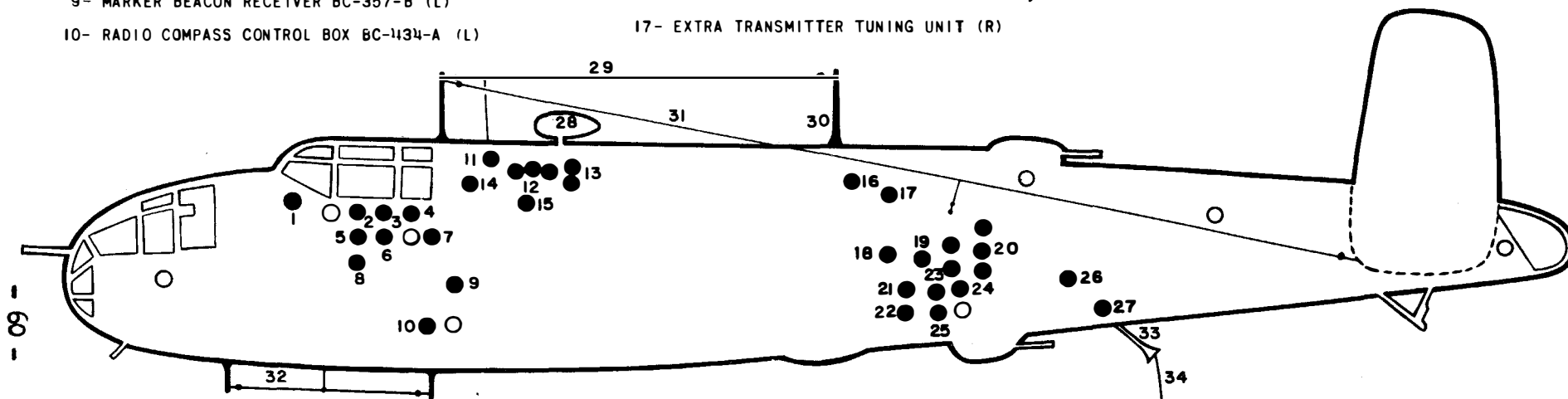

- 26- INTERPHONE AMPLIFIER BC-347 (L)
- 27- AUTOMATIC REEL RL-42-A (L)
- 28- RADIO COMPASS LOOP ANTENNA LP-21-A
- 29- RADIO COMPASS FIXED ANTENNA
- 30- VHF ANTENNA AN-74

31- LIAISON FIXED ANTENNA
(Command set Antenna on opposite side
of plane in same position.)

- 32- MARKER BEACON ANTENNA
- 33- FAIRLEAD F-8
- 34- LIAISON TRAILING ANTENNA
- 35- WEIGHT WT-7-A

LEGEND

- — INTERPHONE JACK BOXES BC-366
- R — RIGHT
- L — LEFT
- C — CENTER

NORTH AMERICAN MITCHELL....B-25

- 1- PILOT'S RADIO COMPASS INDICATOR I-81-A (C)
- 2- FILTER FL-5-A (R)
- 3- JACK BOX BC-366 (R)
- 4- FILTER SWITCH BOX BC-345 (R)
- 5- JACK BOX BC-366 (L)
- 6- RECEIVER CONTROL BOX BC-450-A
- 7- RADIO COMPASS CONTROL BC-434-A (L) 274 N
- 8- FILTER FL-5-E (L)
- 9- FILTER SWITCH BOX BC-345 (L)
- 10- TRANSMITTER CONTROL BOX BC-451-A
- 11- SPARE TRANSMITTER TUNING UNIT
- 12- DYNAMOTOR (LIAISON) PE-75-B (R)

- 13- ANTENNA RELAY UNIT BC-456-A (R)
- 14- RADIO TRANSMITTERS { BC-457-A } (R)
 { BC-458-A }
- 16- COMPASS INDICATOR I-82-A (NAVIGATOR) (L)
- 17- MODULATOR BC-456-A
- 18- RADIO RECEIVERS { BC-453-A } (R)
 { BC-454-A }
 { BC-455-A }

- 19- RADIO RECEIVER BC-348-H (L)
- 20- BC-433-G RADIO COMPASS UNIT (L)
- 21- SGR-211-N FREQUENCY METER (L)
- 22- MARKER BEACON RECEIVER BC-357-B (L)
- 23- INTERPHONE AMPLIFIER BC-347 (L)

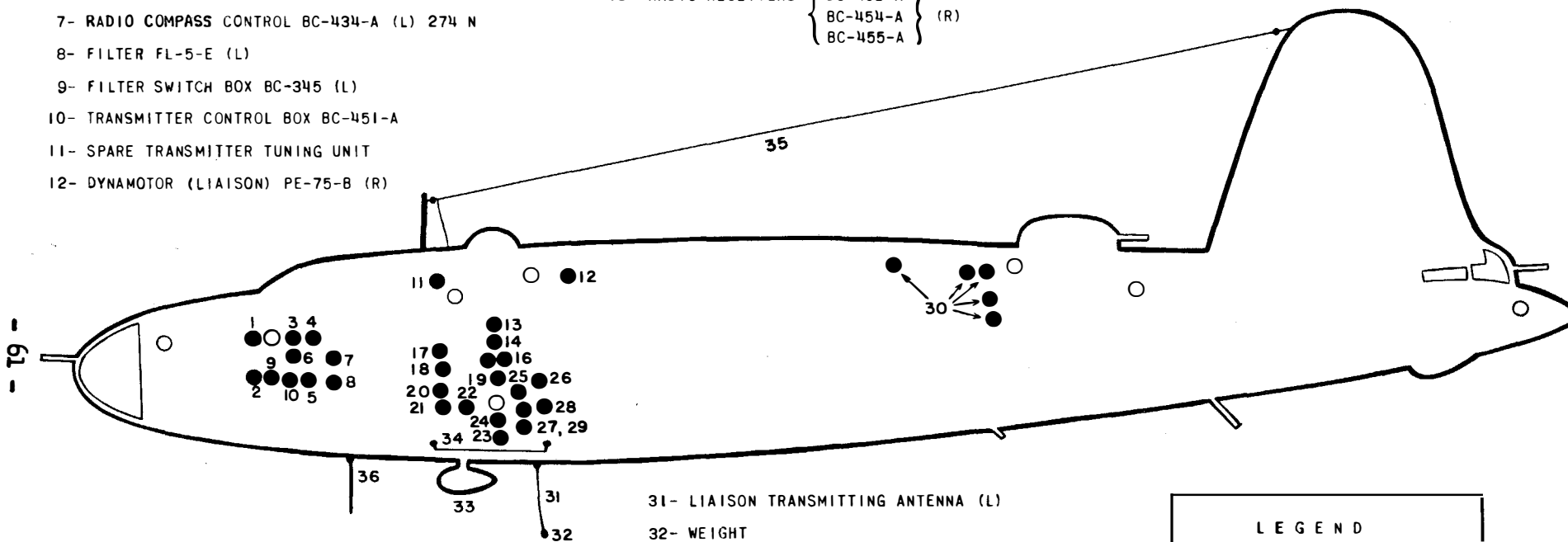

- 24- RADIO COMPASS CONTROL BC-434-A (L)
- 25- REEL CONTROL BOX BC-461
- 26- TRANSMITTER BC-375-C (L)
- 27- ANTENNA TUNING UNIT BC-306-A (L)
- 28- REEL RL-30-B (L)
- 29- SEA RESCUE TRANSMITTER SCR-578-A
- 30- SPARE TUNING UNITS { TU-5-A } (R)
 { TU-6-A, etc. }

- 31- LIAISON TRANSMITTING ANTENNA (L)
- 32- WEIGHT
- 33- LOOP LP-21-A
- 34- MARKER BEACON ANTENNA
- 35- ANTENNA
- 36- RADIO COMPASS WHIP ANTENNA

LEGEND	
○	BC-366 JACK BOXES
L	LEFT
R	RIGHT
C	CENTER

MARTIN MARAUDER... B-26

- 1- PILOT'S RADIO BEARING INDICATOR I-81-A (C)
- 2- COMMAND TRANSMITTER CONTROL BOX BC-451-A (T-C)
- 3- COMMAND RECEIVER CONTROL BOX BC-450-A (T-C)
- 4- RADIO COMPASS CONTROL BOX BC-434-A (T-C)
- 5- FILTER SWITCH BOX BC-345 (R)
- 6- FILTER SWITCH BOX BC-345 (L)
- 7- FILTER UNIT FL-5-E (R)
- 8- FILTER UNIT FL-5-E (L)
- 9- RADIO COMPASS UNIT BC-433-G (R)
- 10- MARKER BEACON RECEIVER BC-357 (C)

- 11- ANTENNA TUNING UNIT BC-308-A (R)
- 12- ANTENNA RELAY UNIT BC-442-A (T-R)
- 13- COMMAND TRANSMITTERS { BC-457-A } (R)
 { BC-458-A }
- 14- LIAISON TRANSMITTER BC-375-C (R)
- 15- COMMAND RECEIVERS { BC-453-A } (R)
 { BC-454-A }
- { BC-455-A }
- 16- REEL CONTROL BOX BC-461 (R)

- 17- LIAISON RECEIVER BC-348-H (R)
- 18- EXTRA TRANSMITTER TUNING UNITS (R)
- 19- LIAISON DYNAMOTOR UNIT PE-73-C (R)
- 20- MODULATOR UNIT BC-456-A (R)
- 21- INTERPHONE DYNAMOTOR PE-86-A (R)
- 22- INTERPHONE AMPLIFIER BC-347 (R)
- 23- FREQUENCY METER SCR-211-N (L)

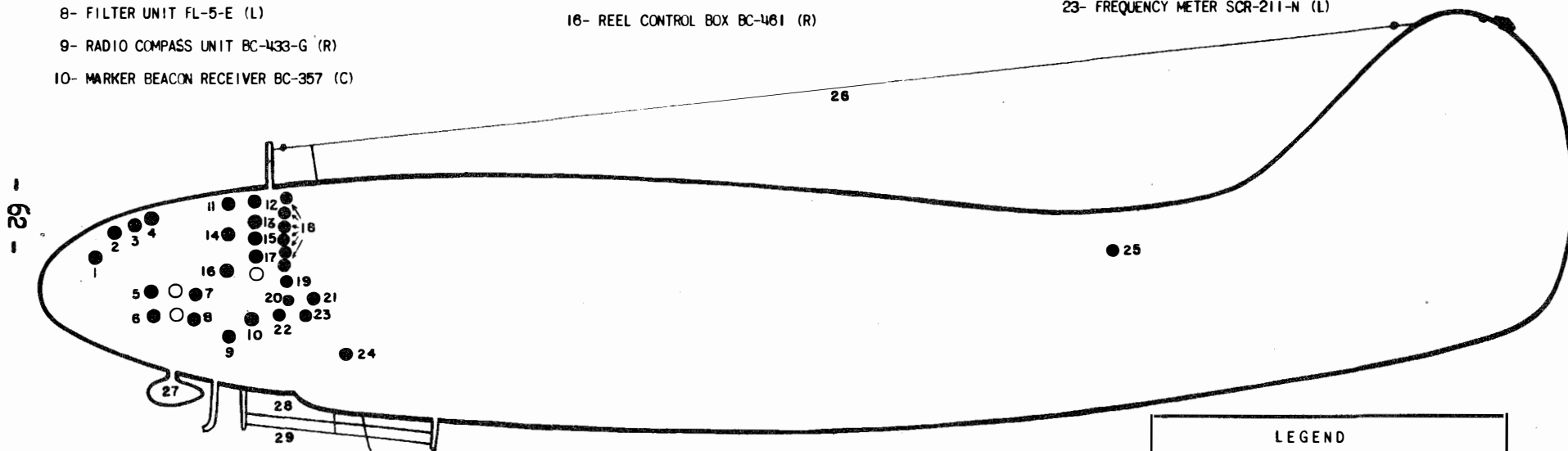

- 24- AUTOMATIC REEL RL-42-A (R)
- 25- EMERGENCY SEA RESCUE TRANSMITTER SCR-578-A
- 26- COMMAND SET ANTENNA
- 27- COMPASS LOOP ANTENNA LP-21-A
- 28- RADIO COMPASS SENSE ANTENNA

- 29- MARKER BEACON ANTENNA
- 30- LIAISON TRANSMITTING ANTENNA
- 31- WEIGHT WT-7-A

CURTISS COMMANDO...C-46

LEGEND	
○	INTERPHONE JACK BOX BC-366
C	CENTER
T	TOP
R	RIGHT
L	LEFT

- 1- RADIO COMPASS INDICATOR I-65-D (L)
- 2- BEARING INDICATOR I-75-A (C)
- 3- MANUAL LOOP ANTENNA CONTROL MC-204 (C)
- 4- TUNING UNIT MC-125-A (T-C)
- 5- RADIO COMPASS CONTROL BOX BC-432-B (T-C)
- 6- BC-AH-231 (T-L)
- 7- BC-AE-232 (T-R)
- 8- FILTER SWITCH BOX BC-345 (L)
- 9- FILTER SWITCH BOX BC-345 (R)
- 10- RADIO FILTER FL-5-E (C)

- 11- RADIO COMPASS UNIT BC-431-A (L)
- 12- EXTRA TRANSMITTER TUNING UNITS (L)
- 13- EXTRA RECEIVING COIL UNITS (R)
- 14- COMMAND RADIO TRANSMITTER BC-AH-230 (R)
- 15- ANTENNA SWITCHING RELAY BC-AE-198 (R)
- 16- INTERPHONE AMPLIFIER BC-212-C (R)

- 17- COMMAND RADIO RECEIVER BC-AH-229 (R)
- 18- REEL CONTROL BOX BC-461 (R)
- 19- LIAISON TRANSMITTER BC-191-C (R)
- 20- LIAISON RECEIVER BC-224-F (R)

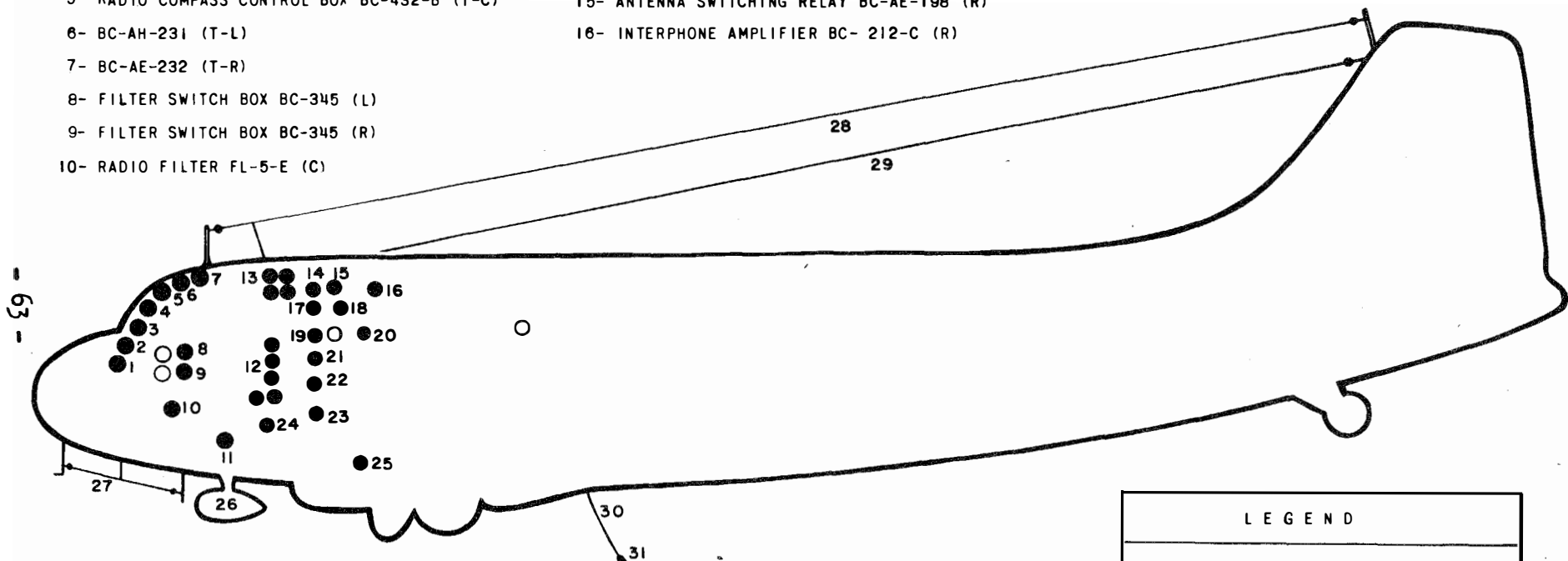

- 21- MARKER BEACON RECEIVER BC-341-B (R)
- 22- LIAISON DYNAMOTOR UNIT BC-77-D (R)
- 23- COMMAND DYNAMOTOR UNIT BD-AG-83 (R)
- 24- FREQUENCY METER SCR-211 N (L)
- 25- REEL RL-42-A (R)
- 26- LOOP LP-19-A
- 27- MARKER BEACON ANTENNA

- 28- LIAISON SET ANTENNA
- 29- COMMAND SET ANTENNA
- 30- LIAISON TRAILING ANTENNA
- 31- WEIGHT

LEGEND	
○	INTERPHONE JACK BOXES BC-366
C	CENTER
R	RIGHT
L	LEFT
T	TOP

DOUGLAS SKYTRAIN...C-47

- 1- PILOT'S RADIO BEARING INDICATOR I-81-A (C)
- 2- RADIO COMPASS CONTROL BOX BC-434-A (C)
- 3- COMMAND RECEIVER CONTROL BOX BC-450-A (C)
- 4- COMMAND TRANSMITTER CONTROL BOX BC-451-A (C)
- 5- RADIO FILTER SWITCH BOX BC-345 (R)
- 6- RADIO FILTER SWITCH BOX BC-345 (L)
- 7- RADIO FILTER UNIT FL-5-E (R)
- 8- RADIO FILTER UNIT FL-5-E (L)
- 9- COMMAND RECEIVERS { BC-453-A
BC-454-A
BC-455-A } (L)
- 10- MODULATOR UNIT BC-456-A (L)

- 11- NAVIGATOR'S RADIO BEARING INDICATOR I-82-A (R)
- 12- LIAISON RECEIVER BC-348-H (L)
- 13- INTERPHONE AMPLIFIER BC-347 (L)
- 14- INTERPHONE DYNAMOTOR PE-86-A (L)
- 15- COMMAND TRANSMITTERS { BC-457-A
BC-458-A } (L)
- 16- ANTENNA TUNING UNIT BC-306-A (L)
- 17- ANTENNA RELAY UNIT BC-442-A (L)
- 18- EXTRA TRANSMITTER TUNING UNIT

- 19- REEL CONTROL BOX BC-461 (L)
- 20- LIAISON TRANSMITTER BC-375-C (L)
- 21- LIAISON DYNAMOTOR UNIT PE-73-G (L)
- 22- FREQUENCY METER SCR-211-N (L)
- 23- RADIO COMPASS UNIT BC-433-G (R)
- 24- EXTRA TRANSMITTER TUNING UNITS
- 25- SEA RESCUE SET SCR-578-A

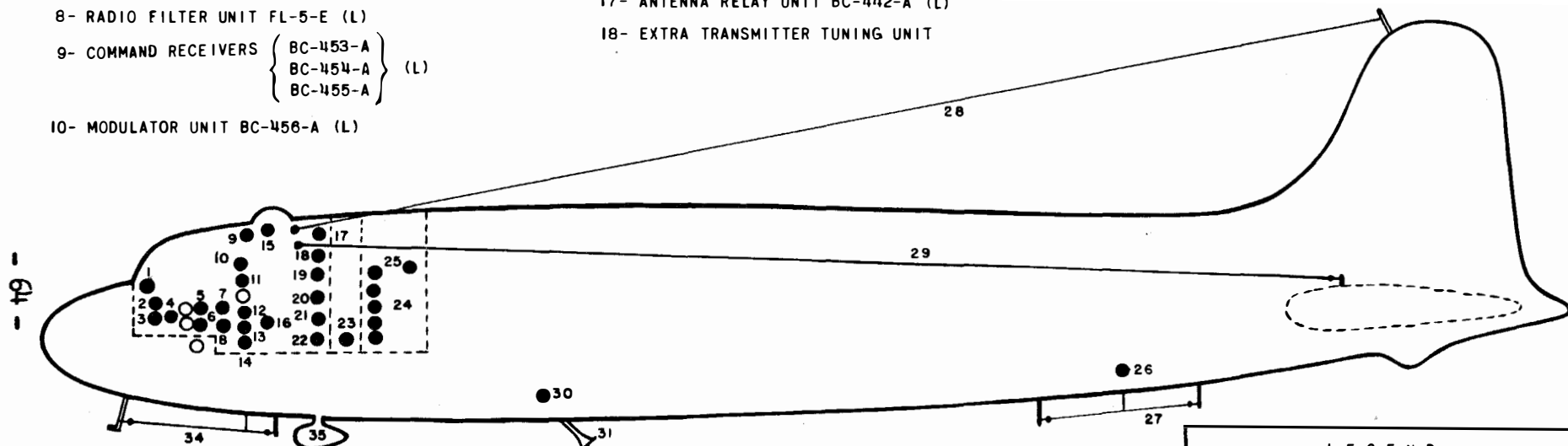

- 26- MARKER BEACON RECEIVER BC-357-B (L)
- 27- MARKER BEACON ANTENNA
- 28- COMMAND SET ANTENNA
- 29- LIAISON SET ANTENNA
- 30- AUTOMATIC REEL RL-42-A (L)
- 31- FAIRLEAD F-8

- 32- LIAISON TRAILING ANTENNA
- 33- WEIGHT WT-7-A
- 34- COMPASS SENSE ANTENNA
- 35- RADIO COMPASS DIRECTIONAL LOOP LP-21-A

DOUGLAS SKYMASTER...C-54

LEGEND	
○	INTERPHONE JACK BOXES BC-366
C	CENTER
R	RIGHT
L	LEFT

- 59 -

- 1- CONTACTOR UNIT BC-808-A (Center Instrument Panel)
- 2- BC-345 FILTER SWITCH BOX (R)
- 3- FL-5-E FILTER (Under Pilot's Seat)
- 4- MODULATOR UNIT BC-458-A (R)
- 5- TRANSMITTER { BC-457-A } (L)
 { BC-458-A }

- 6- RELAY BOX BC-818 (R)
- 7- ANTENNA RELAY UNIT BC-1142-A
- 8- RECEIVERS { BC-453-A } (C)
 { BC-455-A }
- 9- ANTENNA

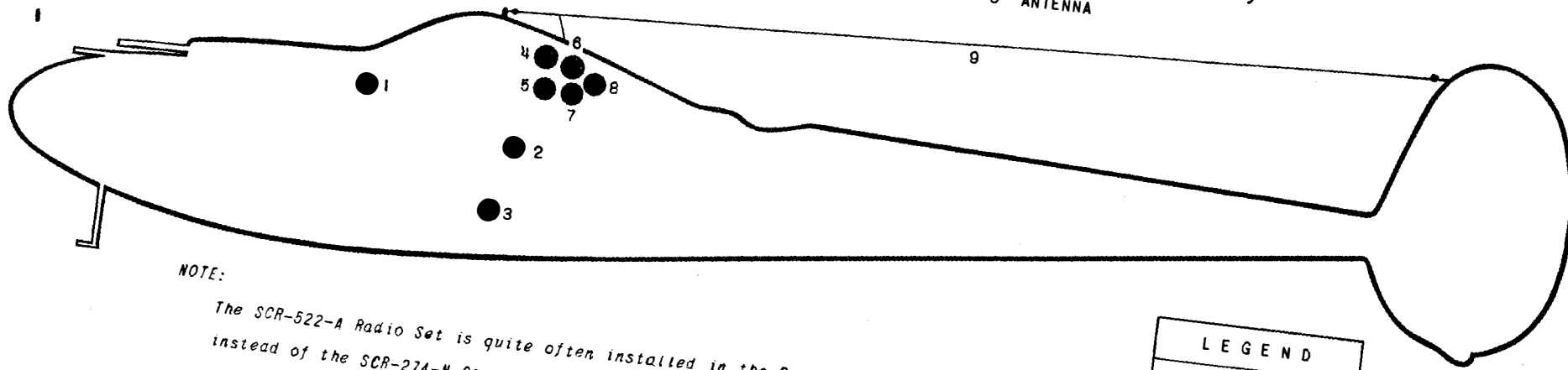

NOTE:

The SCR-522-A Radio Set is quite often installed in the P-38 instead of the SCR-274-W Command Set shown in above drawing.

LOCKHEED LIGHTNING....P-38

LEGEND	
R	Right
L	Left
C	Center

- 1- BC-608-A CONTACTOR UNIT (C) (*Pilot's Instrument Panel*)
- 2- BC-602-A CONTROL BOX (C)
- 3- FL-5-E FILTER (C)
- 4- BC-345 SWITCH BOX (C)
- 5- ANTENNA FOR SCR-522-A

- 6- BC-616 RELAY BOX (R)
- 7- JB-29-A JUNCTION BOX (C)
- 8- BC-624-A } TRANSMITTER & RECEIVER (C)
- BC-625-A }
- 9- PE-94-A DYNAMOTOR UNIT (C)

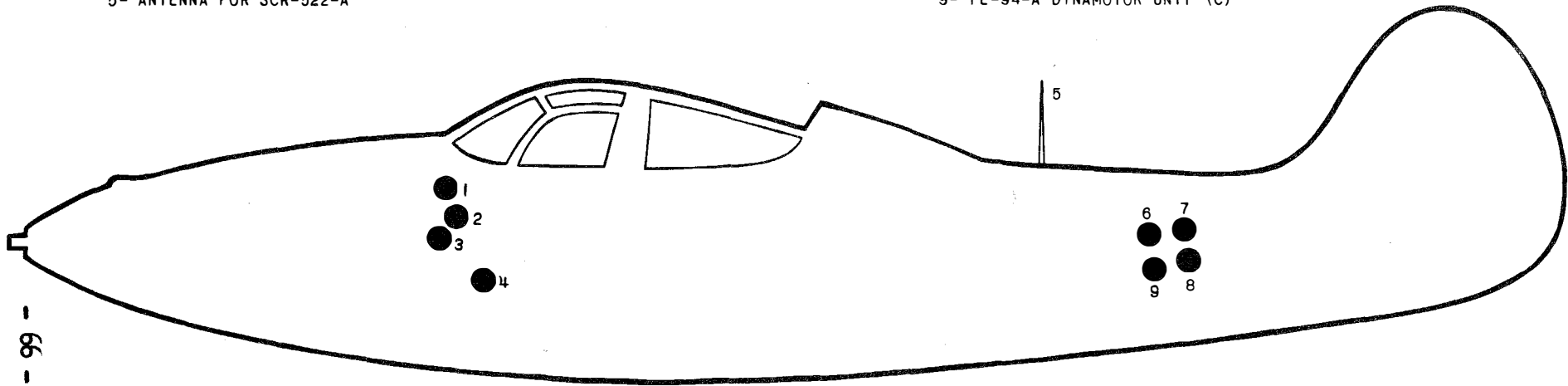

- 99 -

LEGEND	
C	Center
R	Right

NOTE:

The SCR-274-N Command Set is quite often installed in the P-39 instead of the SCR-522 Radio Set shown in above drawing.

BELL AIRACOBRA.....P-39

- 67 -

- 1- BC-450-A RECEIVER CONTROL (R)
- 2- BC-608 CONTACTOR SWITCH (Pilot's Instrument Panel)
- 3- FL-5-E FILTER
- 4- BC-451-A TRANSMITTER CONTROL (R)
- 5- BC-345 FILTER SWITCH BOX (R)

- 6- BC-457-A TRANSMITTER (T) } (R)
- 7- BC-459-A TRANSMITTER (T) } (R)
- 8- BC-442-A ANTENNA RELAY (R)

- 9- BC-453 } RECEIVER (R)
- 10- BC-454 } (R)
- 11- BC-455 }

- 12- ANTENNA
- 13- BC-456-A MODULATOR UNIT
- 14- BC-616

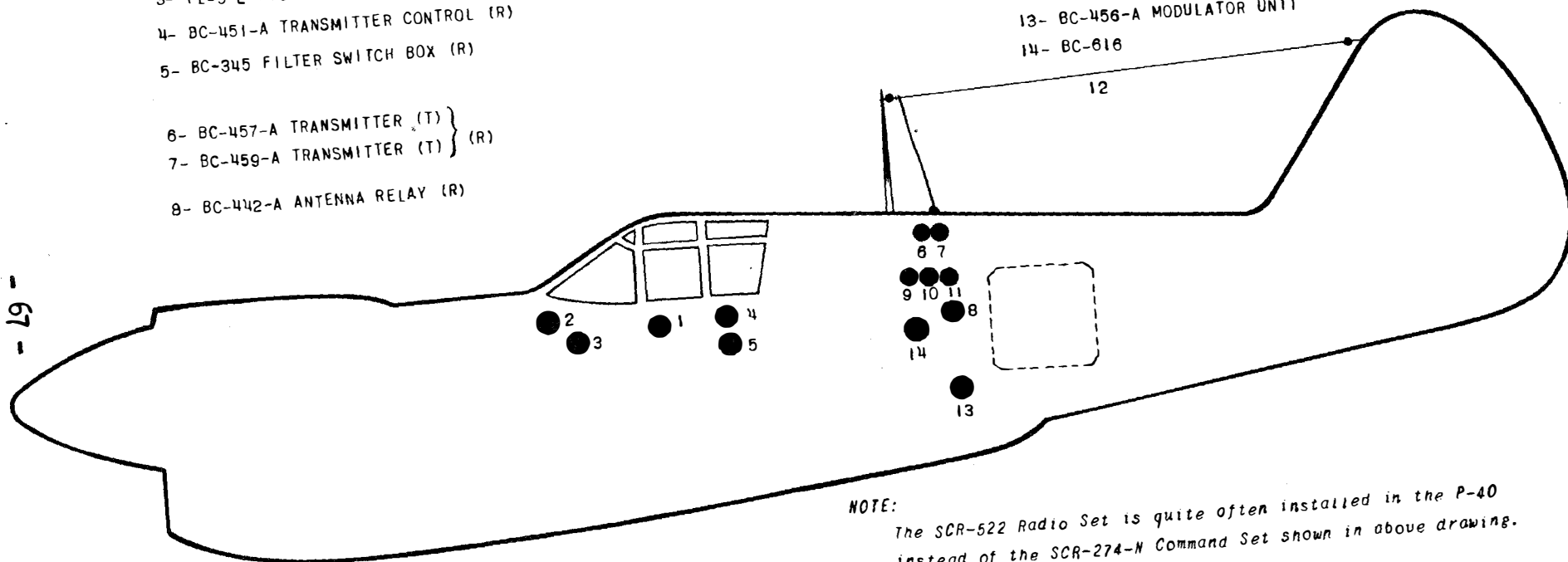

LEGEND	
R	Right
T	Top

CURTISS KITTYHAWK.....P-40

1- BC-608-A CONTACTOR UNIT (*Pilot's Instrument Panel*)

2- BC-450-A RECEIVER CONTROL BOX (R)

3- FL-5-E FILTER (L)

4- BC-345 FILTER SWITCH (L)

5- BC-451-A TRANSMITTER CONTROL BOX (L)

6- BC-442-A ANTENNA RELAY UNIT (C)

7- BC-453-A

8- BC-454-A } RECEIVERS (*On sliding mount*) (C)

9- BC-455-A

10- BC-456-A MODULATOR UNIT (*On sliding mount*) (C)

11- BC-457-A } TRANSMITTERS (C)

12- BC-458-A

13- BC-616 RELAY BOX

14- ANTENNA

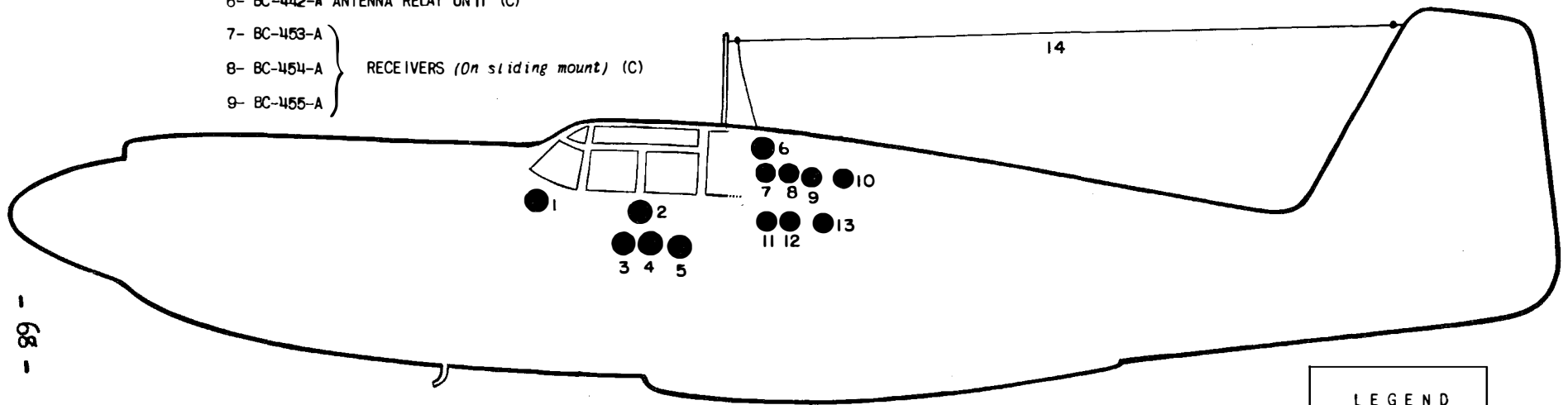

- 68 -

NORTH AMERICAN MUSTANG....P-51

LEGEND	
L	Left
R	Right
C	Center

FILTER EQUIPMENT RC-32

Principal Components: -

Switchbox	BC-345
Filter Unit	FL-5-E
Cord	CD-316

Filter for voice and range; provides following functions between a radio set and a head set:

- (a) Voice-pass and range-reject
- (b) Range-pass and voice-reject
- (c) Pass both voice and range

BC-345 FILTER SWITCHBOX

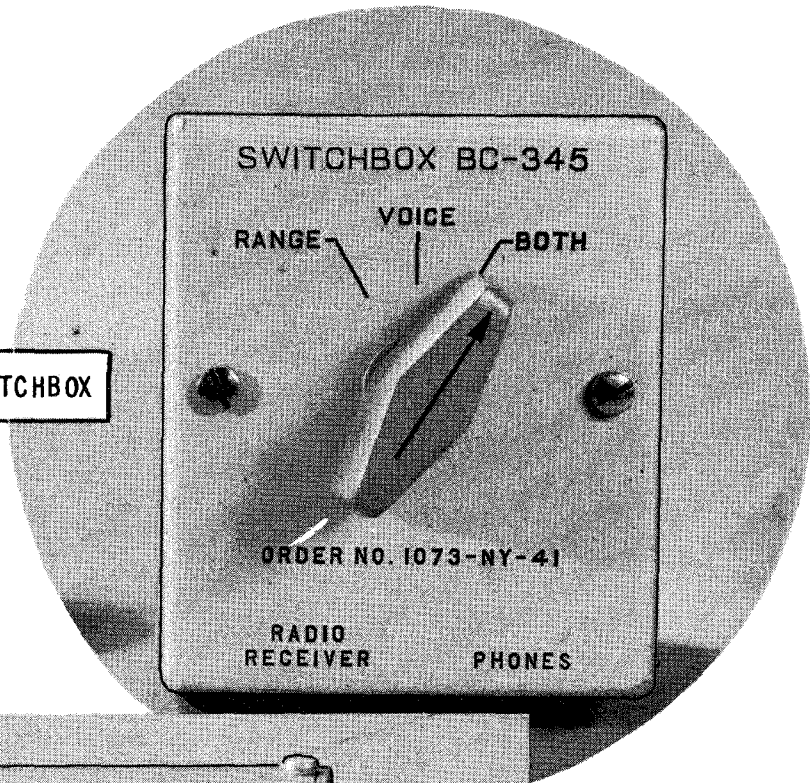

FL-5-E RADIO FILTER

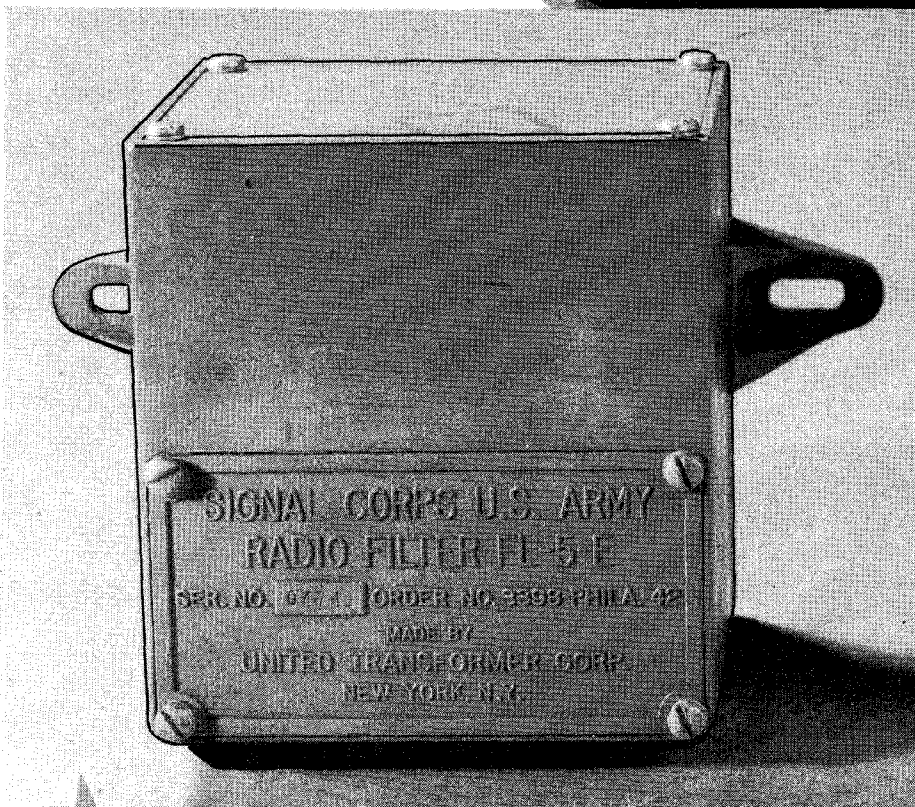

PRINCIPAL COMPONENTS OF
RC-32 FILTER EQUIPMENT

INTERPHONE EQUIPMENT RC-36

Principal Components: -

Interphone Amplifier	BC-347
Jack Box	BC-366
Dynamotor Unit	PE-86-A

Operating Voltage - - - - - 28-v d-c

Interphone equipment RC-36 is designed for multiplace airplanes provided with a 28-volt direct-current primary power source. It provides intraplane communication between the various interphone stations and switching facilities whereby the operation of two complete radio sets and one additional radio receiver can be partially controlled.

BC-347 INTERPHONE AMPLIFIER

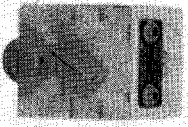
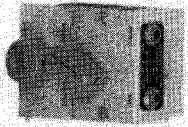
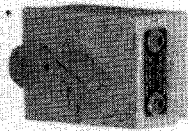
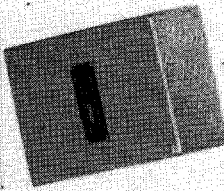

BC-366 INTERPHONE JACK BOXES

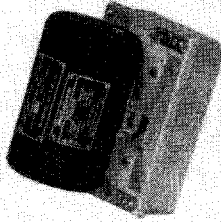

PE-86-A DYNAMOTOR UNIT

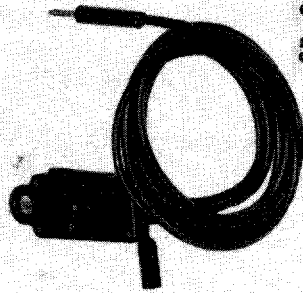

CD-318 CORD

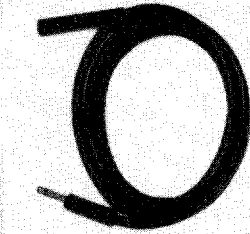

CD-307-A CORD

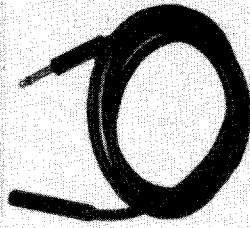

CD-318 CORD

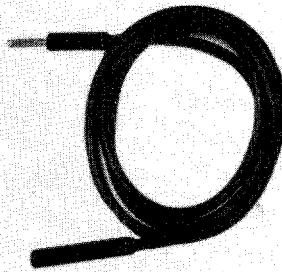
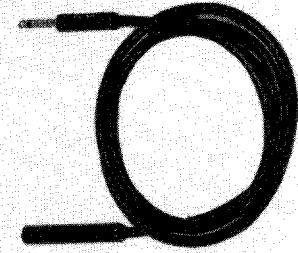
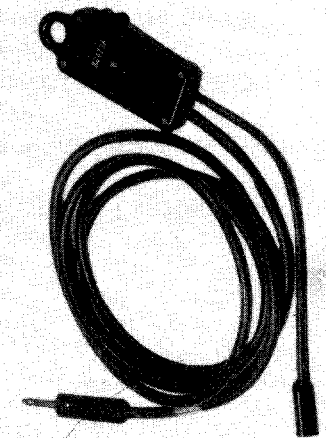

PRINCIPAL COMPONENTS OF
RC-36 INTERPHONE EQUIPMENT

MARKER BEACON RC-39-A

Principal Components: -

Radio Receiver	BC-341-B
Mounting	FT-161
Terminal	TM-187-A
Cable	WC-537
Coupling	MC-192
Cable	WC-538

Operating Voltage - - - - - 14-v d-c

Marker beacon receiving equipment RC-39-A is an ultra-high frequency radio receiving equipment for aircraft. The frequency range of this equipment is from approximately 62 megacycles to approximately 80 megacycles. The purpose of the equipment is to receive 75-megacycle marker beacon signals used in the Army instrument landing system, cone of silence, and fan marker beacons of the Civil Aeronautics Administration, and other facilities employing modulated 75-megacycle horizontally polarized transmissions. The output indication is visual in the form of an indicator lamp on the instrument panel. The indicator lamp flashes in accordance with the keying of the signals of the C.A.A. markers, thereby identifying the transmitter.

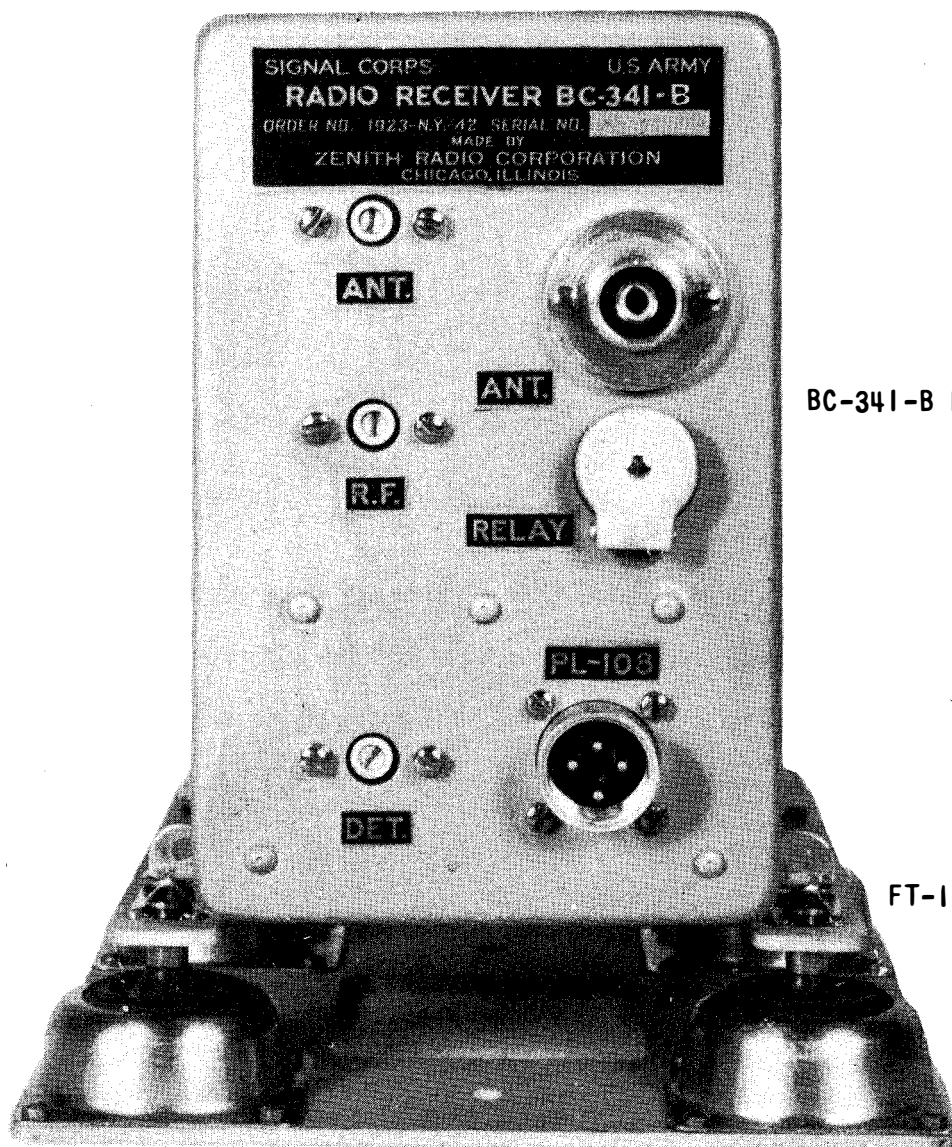

BC-341-B RADIO RECEIVER

FT-161 MOUNTING

PRINCIPAL COMPONENTS OF
RC-39-A MARKER BEACON RECEIVING EQUIPMENT
(Receiver & Mounting only shown)

MARKER BEACON RECEIVING EQUIPMENT RC-43-A

Principal Components: -

Radio Receiver	BC-357-B
Cable	WC-537
Cable	WC-538
Terminal	TM-187-A
Insulator	IN-88
Plug	PL-108

Operating Voltage - - - - - 28-v d-c

Marker beacon receiving equipment RC-43-A is an ultra-high frequency radio receiving equipment for aircraft. The frequency range of this equipment is from approximately 62 megacycles to approximately 80 megacycles. The purpose of the equipment is to receive 75-megacycle marker beacon signals used in the Army instrument landing system, cone of silence, and fan marker beacons of the Civil Aeronautics Administration, and other facilities employing modulated 75-megacycle horizontally polarized transmissions. The output indication is visual in the form of an indicator lamp on the instrument panel. The indicator lamp flashes in accordance with the keying of the signals of the C.A.A. markers, thereby identifying the transmitter.

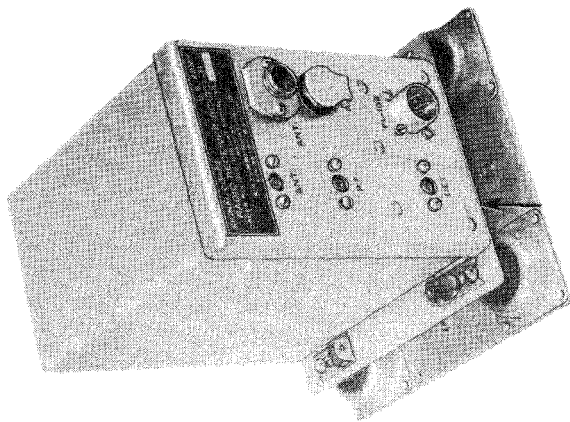

BC-357-B RECEIVER



IN-88 INSULATOR

IN-88 INSULATOR



WC-537 CABLE

TM-187-A TERMINAL

MC-192 COUPLING

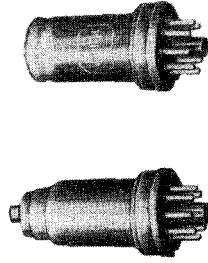

VT-153 TUBE

VT-104 TUBE

WC-538 CABLE

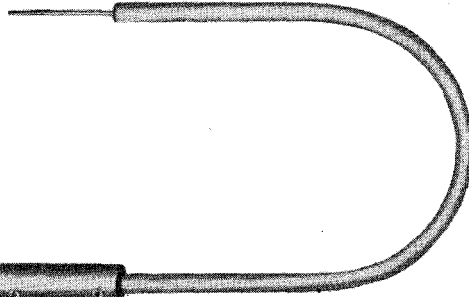

PRINCIPAL COMPONENTS OF
RC-113-A MARKER BEACON RECEIVING EQUIPMENT

INTERPHONE EQUIPMENT RC-45

Principal Components: -

Interphone Amplifier	BC-212-C
Jack Box	BC-366
Cord	CD-307-A

Operating Voltage - - - - - 14-v d-c

Interphone equipment RC-45 is designed for multiplace airplanes provided with a 14-volt direct-current primary power source. It provides intraplane communication between the various interphone stations and switching facilities whereby the operation of two complete radio sets and one additional radio receiver can be partially controlled.

NOTE: - Cord CD-318 required if T-30 microphone is used.

BC-212-C INTERPHONE AMPLIFIER

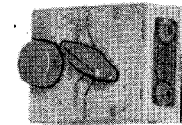
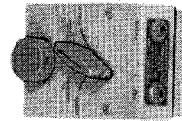
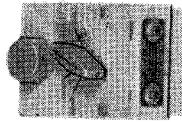
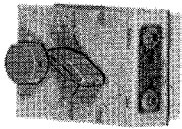
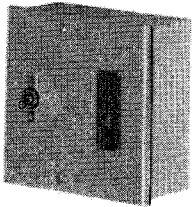

BC-366 INTERPHONE JACK BOXES

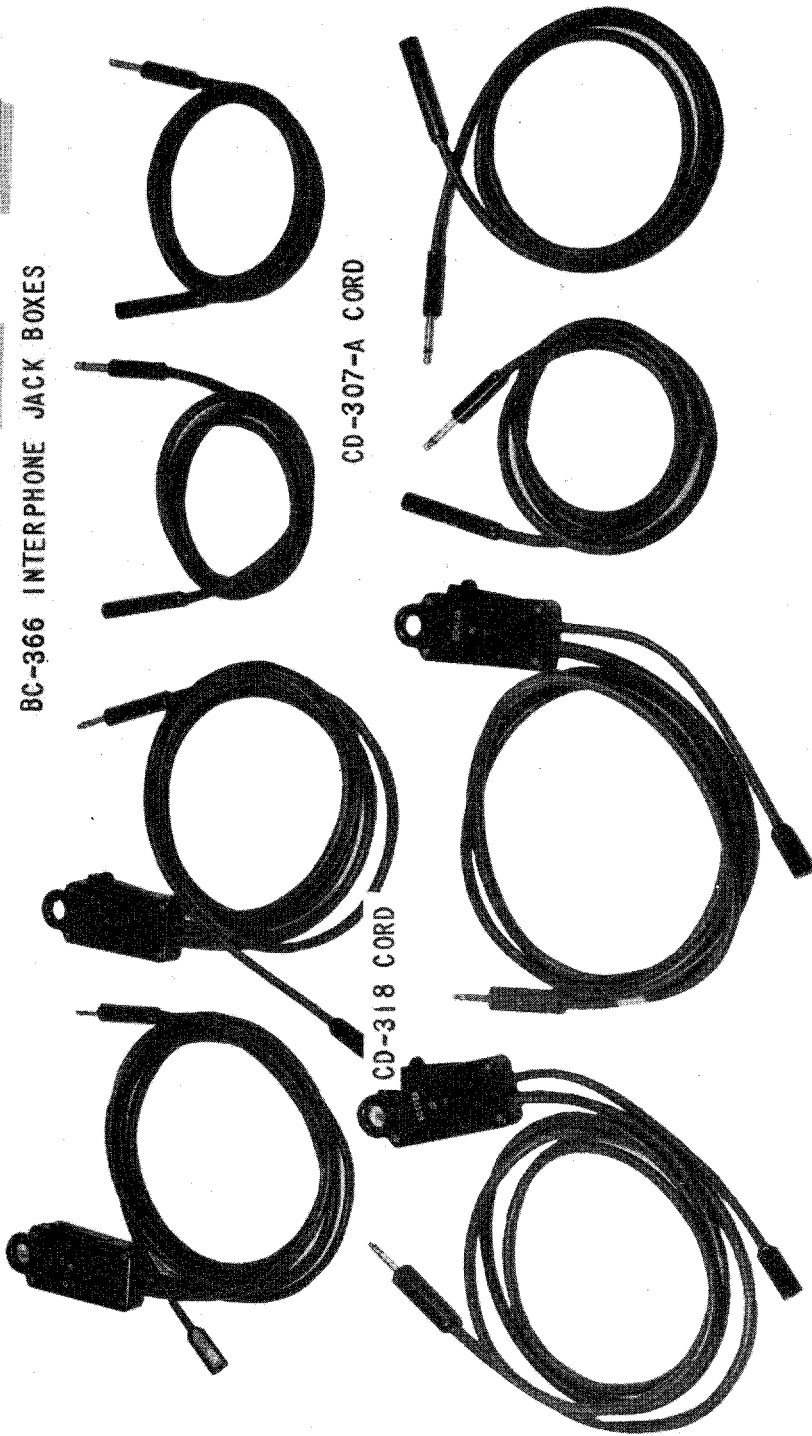

PRINCIPAL COMPONENTS OF
RC-45 INTERPHONE EQUIPMENT

INTERPHONE EQUIPMENT RC-51

Principal Components: -

Interphone Amplifier	BC-347
----------------------	--------

Jack Box	BC-213-B
----------	----------

Operating Voltage - - - - - 28-v d-c

Interphone equipment RC-51 is designed for multiplace airplanes provided with a 24-volt direct-current primary power source. It provides intraplane communication between the various interphone stations and switching facilities whereby the operation of two complete radio sets can be partially controlled.

NOTE: BC-347-A modified or BC-347-C now used instead of BC-347.

PRINCIPAL COMPONENTS OF
RC-51 INTERPHONE EQUIPMENT

- 08 -

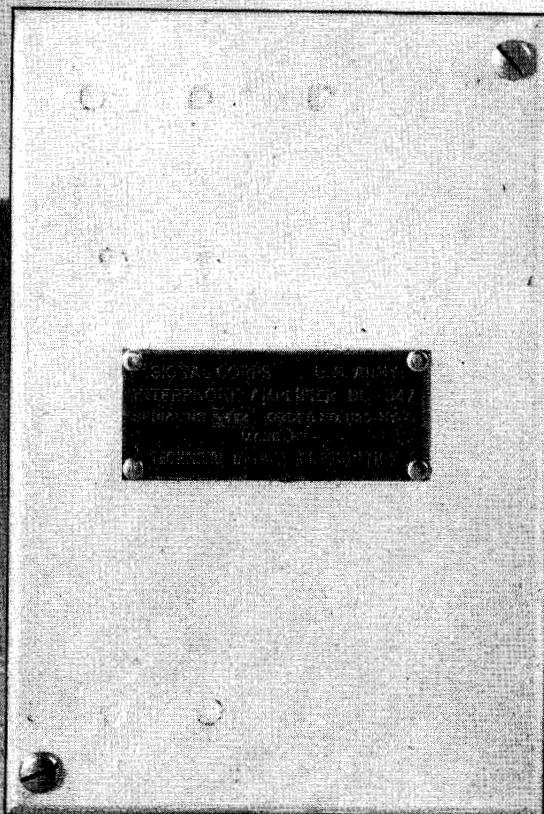

BC-347 INTERPHONE AMPLIFIER

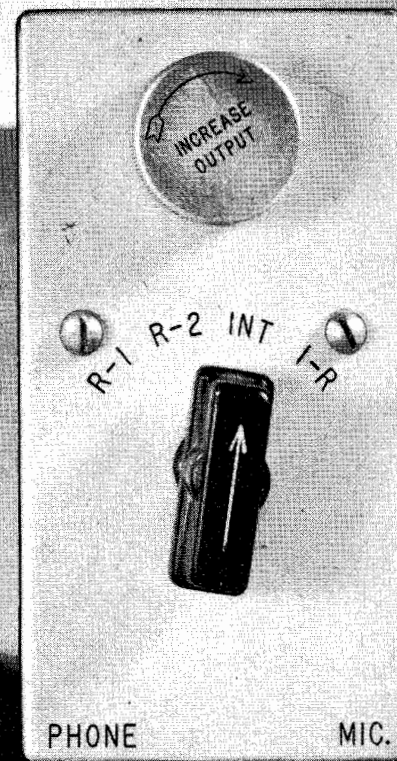

BC-213-B JACK BOX

CONTACTOR EQUIPMENT RC-96-A

Principal Components:

Contactor Unit	BC-608-A
Relay Box	BC-616

Operating Voltage - - - - - 28-v d-c

Relay box BC-616, adapts radio set SCR-274-N for operation with contactor unit BC-608 and is part of contactor equipment RC-96-().

The purpose of this equipment is to enable the contactor unit to automatically put radio set transmitter No. 1 on continuous wave, keydown, whenever the contactor control circuit is closed.

The relay box is so connected into the radio set control circuits, that, when the contactor circuit closes, the relay box takes over control of the radio equipment, irrespective of the settings of either the transmitter or receiver control boxes.

After transmitting a short burst of tone on the channel indicated on the transmitter control box, the relay switches over to channel No. 1 and transmits a continuous wave, signal for the duration of the contact period.

When the contactor circuit opens, the radio equipment is immediately restored to the condition indicated by the position of the various controls on the control boxes.

Contactor unit BC-608-A is part of contactor equipment RC-96-A. It is designed for use in U.S. Army aircraft to control a radio transmitter so that it will automatically transmit a predetermined type of signal on a predetermined carrier frequency for a period of approximately 14 seconds of each minute. The control circuit in the contactor units consists of a cam-driven set of contacts and must be used in conjunction with suitable relays in order to provide the above described control function. In some cases, the necessary relays are an integral part of the transmitter, while in others they are assembled in a relay box which is inserted in the control circuit between the transmitter and its remote control box. The contactor units are delivered fully adjusted and regulated. Adjustments should not be attempted in the field.

NOTE: Relay BC-616 not used with SCR-522 installations.

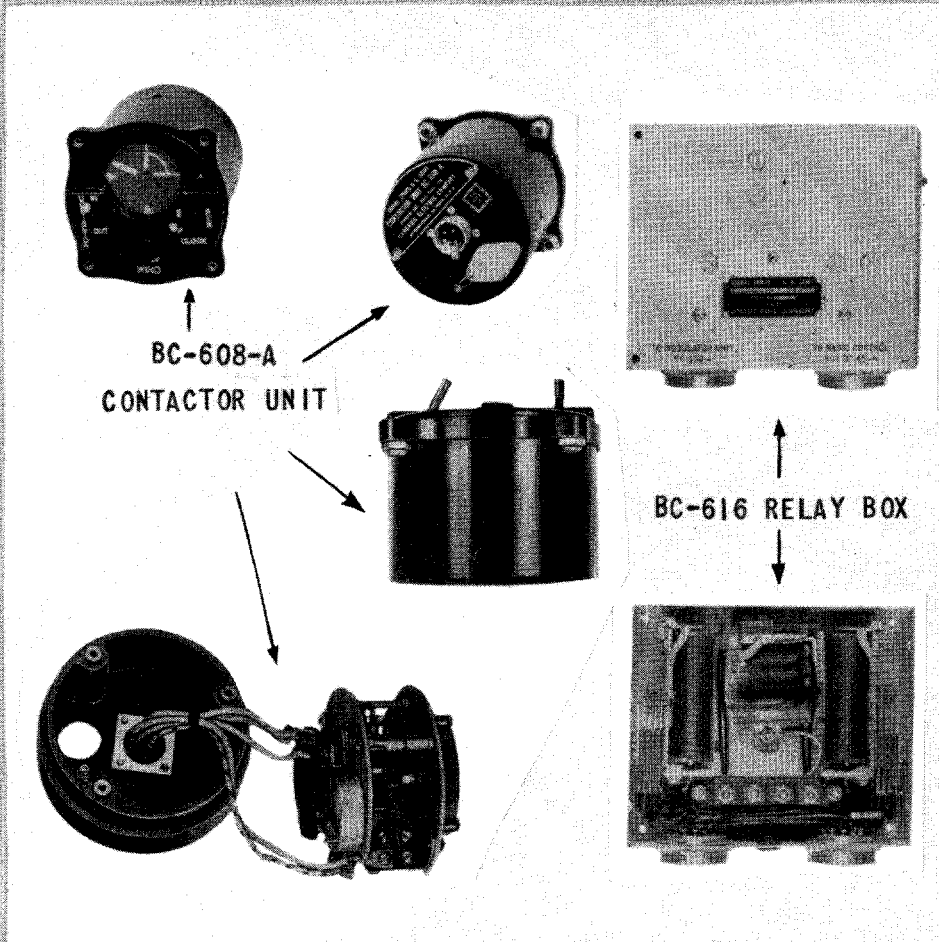

PRINCIPAL COMPONENTS OF
RC-96-A CONTACTOR EQUIPMENT

COMMAND SET SCR-AJ-183
Receiving and Transmitting

Principal Components: -

Dynamotor Unit	BD-AG-83
Antenna Switching Relay	BC-AE-198
Transmitting Coil-Sets Types	C-216, C-217, C-218 C-219, C-220
Receiving Coil Set	C-171, C-172
Receiving Coil Unit (Dual)	C-155-A, C-153-A
Radio Transmitter	BC-AH-230
Radio Receiver	BC-AH-229
Junction Box	TM-AH-172
Receiver Control Box	BC-AH-231
Transmitter Control Box	BC-AE-232
Tuning Unit	MC-125-A
Tuning Shaft	MC-124

Operating Voltage - - - - - 14-v d-c

Radio set, type SCR-AJ-183 is intended for installation and operation in aircraft. The radio set may be used to receive modulated or damped-wave signals at any frequency within its range. The transmitter may be used to transmit unmodulated, tone-modulated, or voice-modulated signals at any frequency within its range.

NOTE: See Signal Corps Stock Catalog for use of receiving coil sets.

BC-AH-230 TRANSMITTER

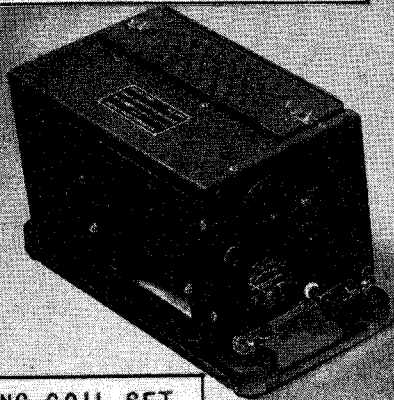

BC-AH-229 RECEIVER

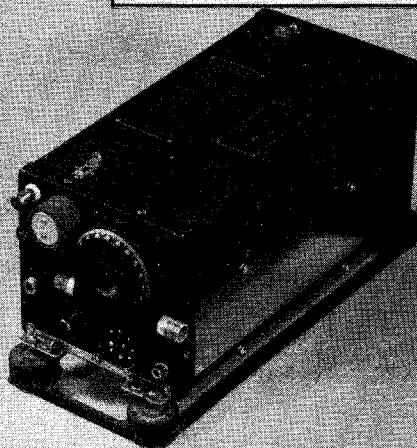

RECEIVING COIL UNITS

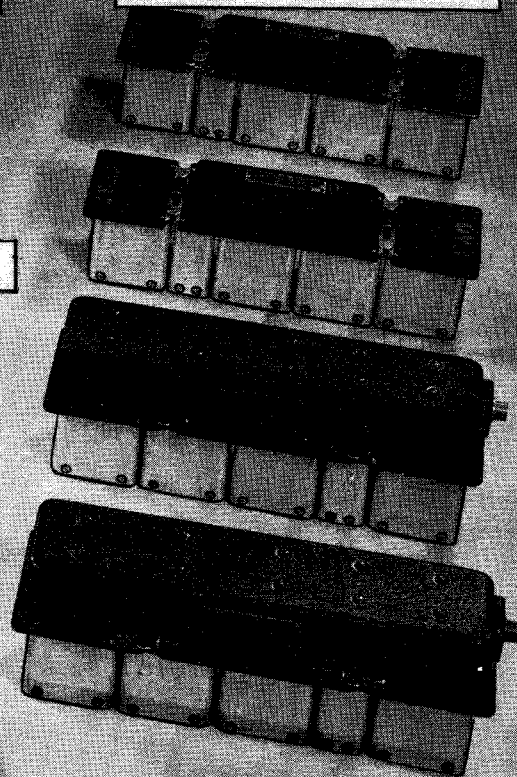

TRANSMITTING COIL SET

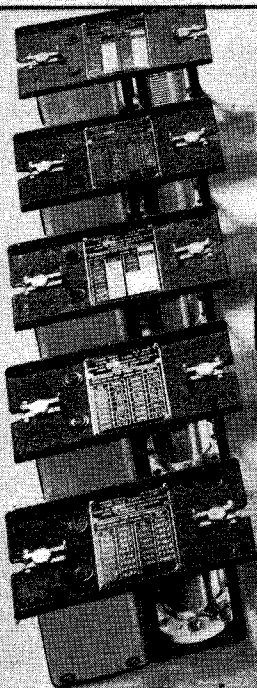

TM-AH-172 JUNCTION BOX



BD-AG-83 DYNAMOTOR UNIT

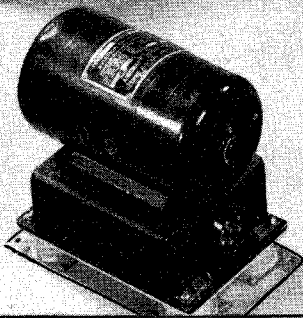

BC-AE-198 ANTENNA SWITCHING RELAY

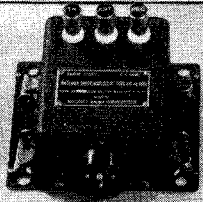

BC-AE-232 TRANSMITTER CONTROL BOX

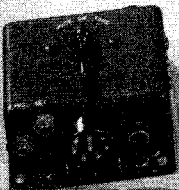

BC-AH-231 RECEIVER CONTROL BOX



PRINCIPAL COMPONENTS OF SCR-AJ-183 RADIO SET (COMMAND)

- 58 -

NOTE: The SCR-AJ-183 radio set is used in this manual for illustrative purposes only. The SCR-AL-183 and later series (AN, AO, etc.) is now used. Physically the SCR-AJ-183 components look the same as the SCR-AL-183 series and later. See Signal Corps Stock Catalog for correct listing of component units.

NOTE: The SCR-()-283 radio set will be used in the new C-47 and the C-53 planes as they have a 28-volt supply.

This Page Intentionally Blank

RADIO SET (LIAISON) SCR-187-A

Principal Components: -

Transmitter	BC-191-C
Receiver	BC-224-F
Antenna Tuning Unit	BC-306-A
Dynamotor Unit	BC-77-D
Transmitter Control Box	BC-309
Fair-lead	F-8
Mounting	FT-115-B
Reel	RL-30-B or RL-42-A
Transmitter Tuning Units	TU-5-A, TU-6-A, TU-7-A, TU-8-A, TU-9-A, TU-10-A, TU-22-A

Operating Voltage - - - - - 14-v d-c

The SCR-187-A is a liaison set, receiving and transmitting, medium power for use in aircraft. It may be used to receive modulated or unmodulated signals at various frequencies. Provides observation liaison communication by unmodulated, tone and voice transmission up to 500, 250, and 75 miles respectively.

Radio transmitter BC-191-C with its associated equipment is designed for aircraft, and various applications requiring medium power equipment with the characteristics of strength, light weight, flexibility, and portability. The equipment is designed to provide communication by voice, tone, or continuous-wave telegraphy.

Suitable tuning equipment is provided in the radio transmitter to permit operation into a wide range of antennas over most of the frequency range. Antenna tuning unit BC-306-A may be used to extend the range of antenna tuning for frequencies between 150 and 800 kilocycles.

Radio receiver BC-224-F is a locally controlled superheterodyne receiver for use in U.S. Army aircraft. These receivers are capable of voice, tone, and continuous-wave reception with manual or automatic volume control. The receiver when equipped with tubes, dial lights, and fuses, and with the antenna, ground, and primary power source connections properly made, become complete and operative equipments by the addition of head sets, as all coils built into the receivers.

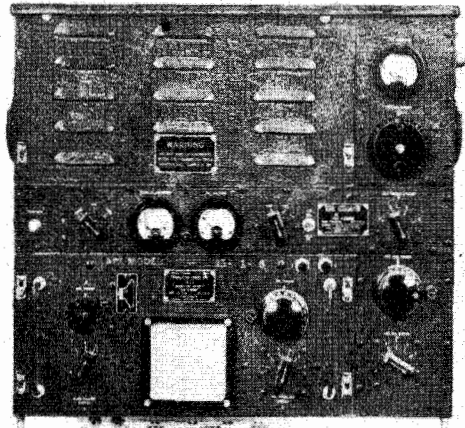

BC-191-C TRANSMITTER

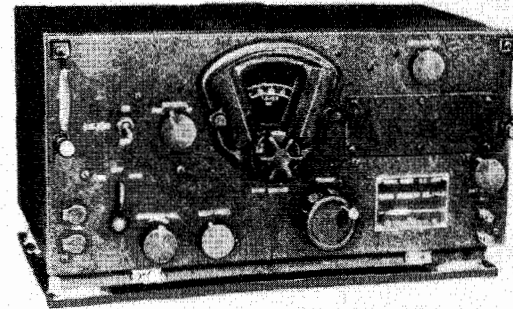

BC-224-F RECEIVER

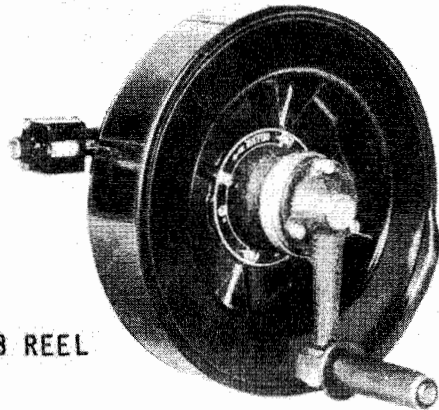

RL-30-B REEL

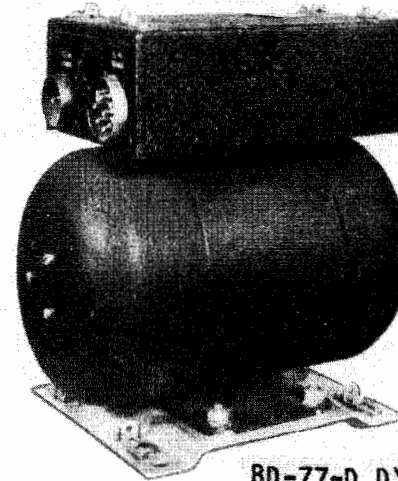

BD-77-D DYNAMOTOR UNIT

PRINCIPAL COMPONENTS OF
SCR-187-A LIAISON RADIO SET

FREQUENCY METER SET SCR-211-N

Principal Components: -

Bag	BG-81-N
Frequency Meter	BC-221-N
Head Set	P-18 or P-20
Crystal Unit	DC-9-N

Frequency meter set SCR-211-N has been specially designed to provide simple, accurate, and reliable frequency indicating equipment of the crystal calibrated type for use in the laboratory and afield. Since it is completely portable and self-contained, it is particularly adaptable for adjusting aircraft radio transmitters and receivers to any desired frequency in the range of from 125 to 20,000 kilocycles. The equipment provides accuracies of 0.01 percent of plus or minus 500 cycles, whichever is the greater, at any ambient temperature in the range of from minus 30° to plus 50°C.

SCR-221-N FREQUENCY METER

BG-81-N BAG

- 90 -

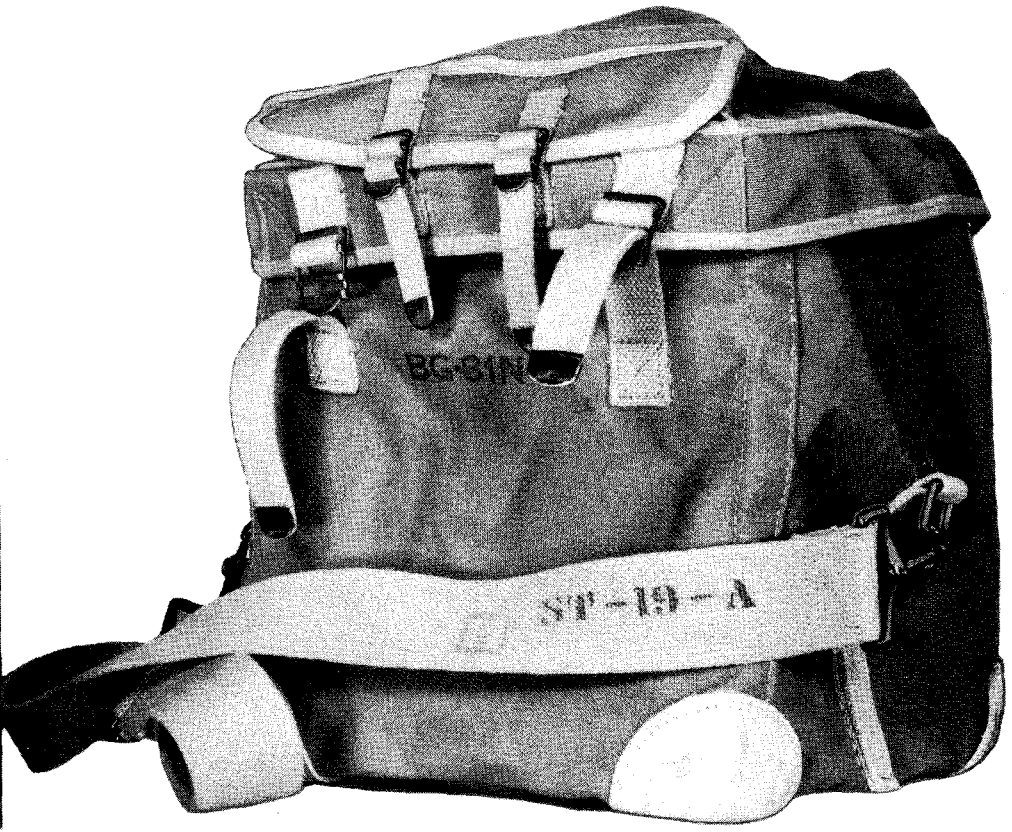
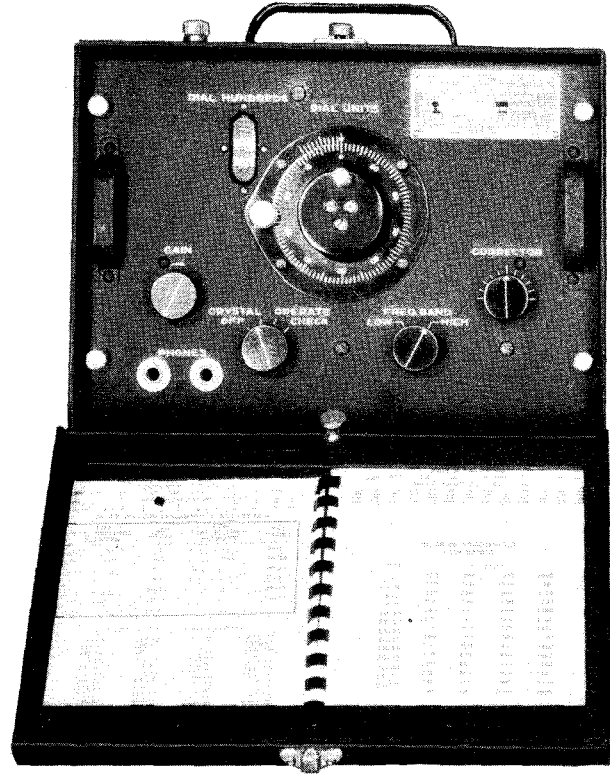

PRINCIPAL COMPONENTS OF SCR-211-N FREQUENCY METER SET

RADIO COMPASS SCR-269-G

Principal Components: -

Radio Compass Unit	BC-433-G
Mounting	FT-213-A
Radio Compass Control Box	BC-434-A
Mounting	FT-224-A
Loop	LP-21-A
Bearing Indicator	I-81-A (Pilot)
Bearing Indicator	I-82-A (Navigator)
Cord	CD-365
Relay	BK-22-A
Coupling	MC-203-A
Tuning Shaft	MC-124

Operating Voltage - - - - -28-v d-c and
115-v 400-cycle a-c

Radio compass SCR-269-G was designed primarily to be used as a navigational instrument in U.S. Army aircraft. The equipment is basically a 15-tube superheterodyne radio receiver with the addition of certain essential circuits necessary for radio compass operation. The equipment is designed for remote control operation and may be installed with provisions for dual control or for signal control. For dual-control installations, two remote controls are provided and, although only one remote control functions at one time, control may be readily switched from one to the other. When installations are

made using only one remote control, no switching of control is necessary and the one radio control box has control at all times.

When used in conjunction with a suitable nondirectional (vertical) antenna, one or two head sets, a 28-volt direct-current supply, a 115-volt, 400-cycle power supply, and necessary interconnecting wiring, radio compass SCR-269-C is a complete operable unit capable of providing: (a) automatic bearing indication of the direction of arrival of radio frequency energy and simultaneous aural reception of modulated or unmodulated radio frequency energy; (b) aural reception of modulated or unmodulated radio frequency energy using a nondirectional antenna; (c) aural reception of modulated or unmodulated radio frequency energy using a loop antenna; (d) aural-null directional indications of the arrival of modulated or unmodulated radio frequency energy using a loop antenna.

PRINCIPAL COMPONENTS OF
SCR-269-G AUTOMATIC RADIO COMPASS

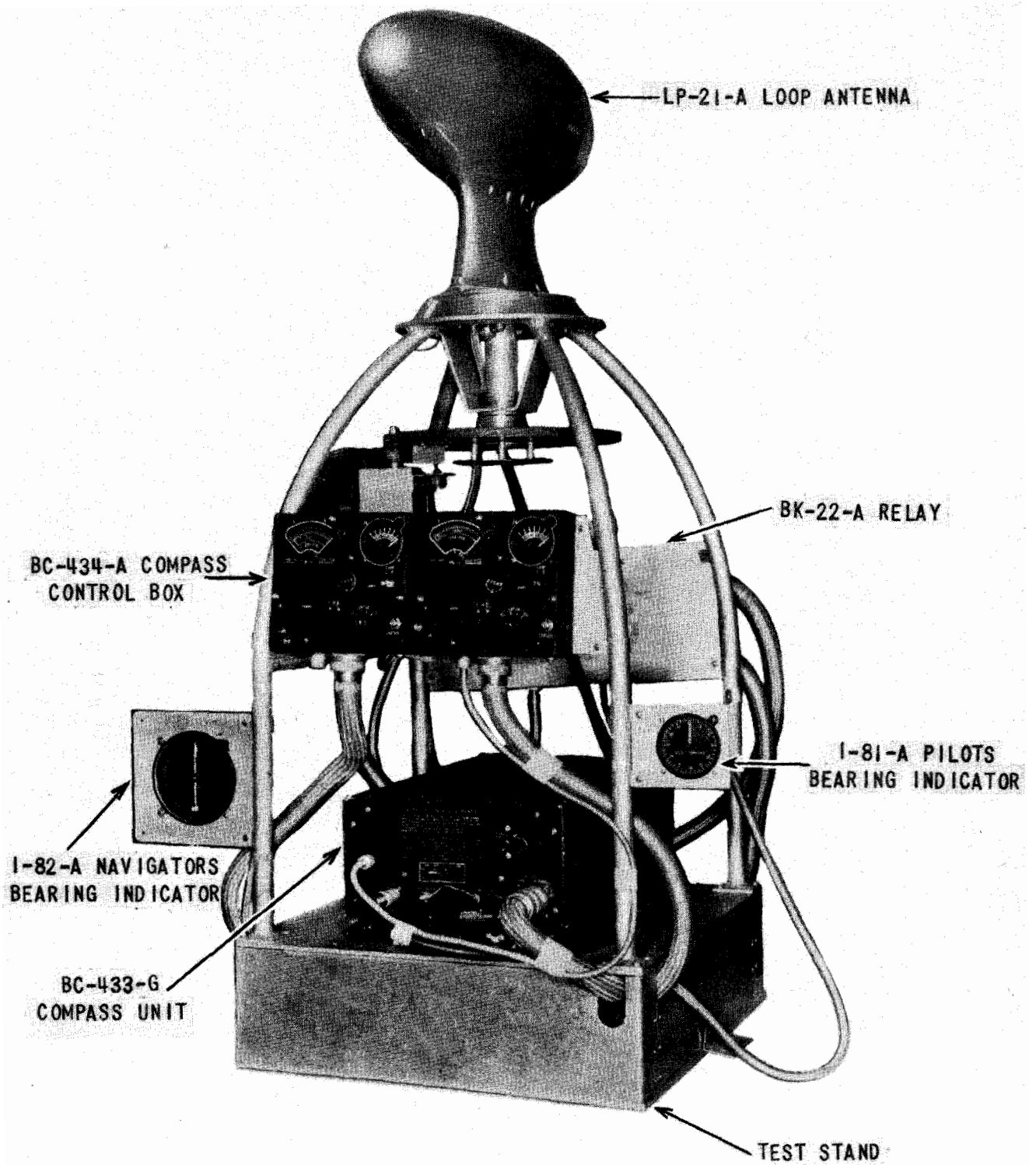

RADIO SET (COMMAND) SCR-274-N

Principal Components: -

Radio Receivers	BC-453-A BC-454-A BC-455-A
Radio Transmitters	BC-457-A BC-458-A
Receiver Control Box	BC-450-A
Transmitter Control Box	BC-451-A
Modulator Unit	BC-456-A
Dynamotor	DM-33-A
Dynamotor	DM-32-A
Antenna Relay Unit	BC-442-A
Ammeter	I-71-B
Coupling	MC-211-A

Operating Voltage - - - - - 28-v d-c

Radio set SCR-274-N is a multichannel aircraft radio receiving and transmitting equipment.

The receiving equipment has been designed for either local or remote control, but only remote control accessories are provided as part of this radio set.

Continuous wave (CW), or amplitude modulated (MCW) radio signals may be received. Manual control of sensitivity is employed, aided by a built-in auxiliary control circuit which prevents strong radio signals from blocking reception. No provision is made for complete automatic gain control.

The output of all receivers may be paralleled on one line to a signal head set, or may be separated and fed to two lines for split or double head set reception by more than one operator. Several head sets HS-23 (8000 ohms impedance per head set) may be used.

PRINCIPAL COMPONENTS OF
SCR-274-N RADIO SET (COMMAND)



BC-451-A TRANSMITTER CONTROL BOX

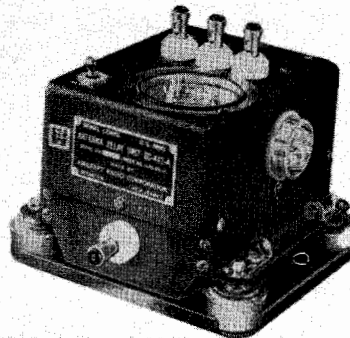

BC-442-A ANTENNA RELAY UNIT

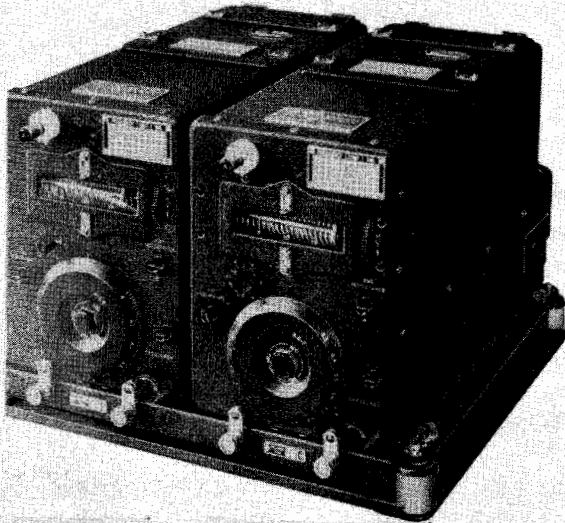

BC-457-A & BC-458-A TRANSMITTERS

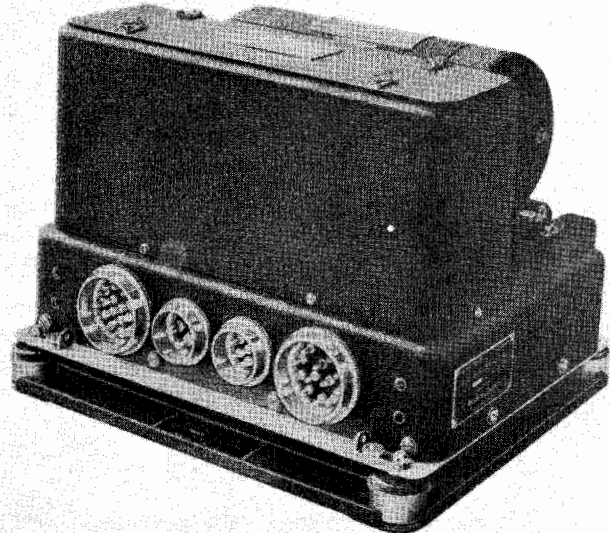

BC-456-A MODULATOR UNIT



BC-454-A; BC-453-A; BC-455-A
RADIO RECEIVERS

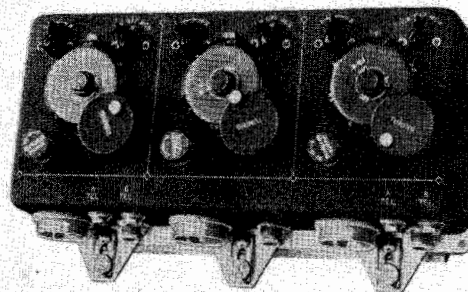

BC-450-A RECEIVER CONTROL BOX

RADIO COMPASS SCR-280-A

Principal Components: -

Pilots Compass Indicator	I-65-D
Loop	LP-19-A
Radio Compass Unit	BC-431-A
Control Unit	MC-204
Navigators Bearing Indicator	I-75-A
Relay	BK-21-B
Radio Control Box	BC-432-B
Dynamotor	DM-20-A
Operating Voltage - - - - -	14- v d-c

Radio compass SCR-280-A is intended primarily for use in U.S. Army aircraft. It may be remotely controlled from either of two positions. While the tuning may be accomplished from either of the remote positions, only that position having control may switch bands. When used in conjunction with the required additional equipment, radio compass SCR-280-A is a complete operable equipment capable of providing: (a) visual, unidirectional, right-left indication of the arrival of radio frequency energy with respect to the plane of the loop and simultaneous "On Course" aural reception of modulated radio frequency energy; (b) aural antenna; (c) aural reception of modulated radio frequency energy, using a loop antenna; and, (d) aural-null directional indications of the arrival of modulated radio frequency energy with respect to the plane of the loop, using a loop antenna.

PRICIPAL COMPONENTS OF
SCR-280-A RADIO COMPASS

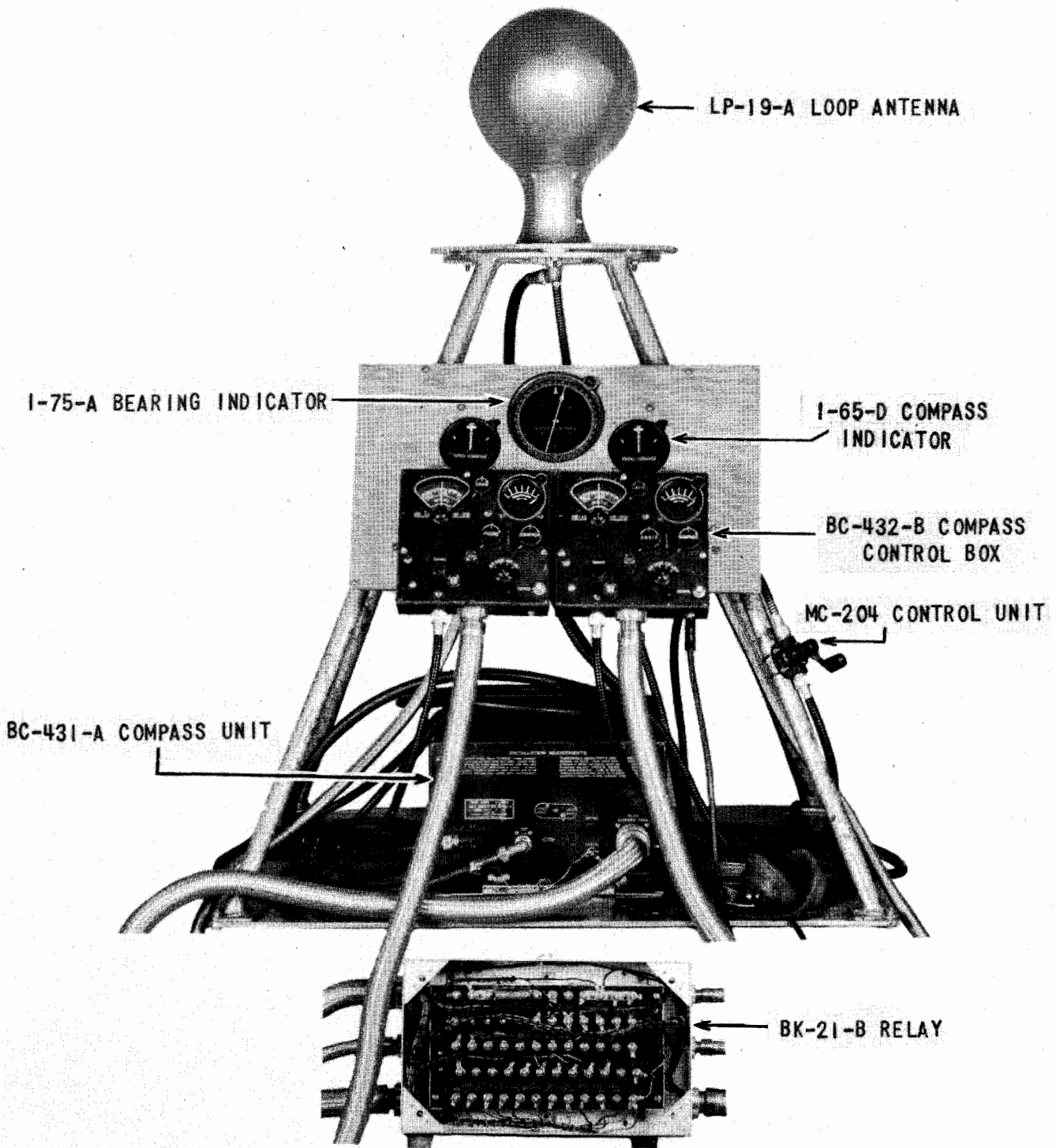

RADIO SET (LIAISON) SCR-287-A

Principal Components: -

Transmitter	BC-375-C
Receiver	BC-348-H
Antenna Tuning Unit	BC-306-A
Dynamotor Unit	PE-73-C
Fair-lead	F-8
Reel	RL-42-A
Reel Control Box	BC-461
Transmitter Tuning Units	TU-5-A, TU-6-A, TU-7-A, TU-8-A, TU-9-A, TU-10-A, TU-26-B
Weight	WT-7-A

Operating Voltage - - - - - 28- v d-c

The SCR-287-A is a liaison set, receiving and transmitting, medium power for use in aircraft. It may be used to receive modulated or unmodulated signals at frequencies. Provides observation liaison communication by unmodulated, tone and voice transmission up to 500, 250, and 75 miles respectively.

Radio receivers and BC-348-H is a locally controlled, eight-tube, six-band superheterodyne receiver for use in U.S. Army aircraft. The receivers are not intended for remote control, and no features or units have been provided for remote control operation. These receivers are capable of voice, tone, and continuous-wave reception with manual or automatic volume control.

Radio transmitter BC-375-C with its associated equipment is designed for aircraft requiring a medium power equipment with the characteristics of strength, light weight, flexibility, and portability. The equipment is designed to provide communication by voice, tone, or continuous-wave telegraphy. Suitable tuning equipment is provided in the radio transmitter to permit operation into a wide range of antennas over most of the frequency range. Antenna tuning unit BC-306-A may be used to extend the range of antenna tuning for frequencies between 150 and 800 kilocycles.

PRINCIPAL COMPONENTS OF
SCR-287-A RADIO SET (LIAISON)

F-8 FAIRLEAD

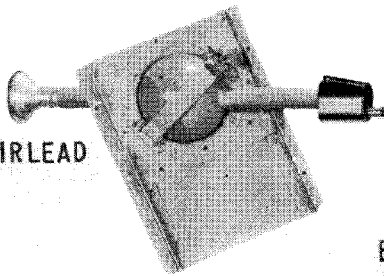

BC-461 REEL
CONTROL BOX

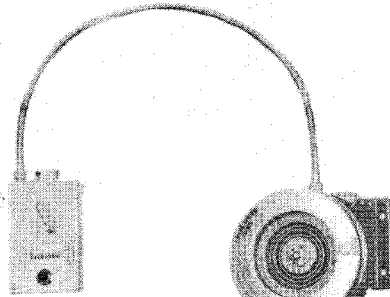

RL-42-A
REEL

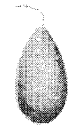

WT-7-A WEIGHT

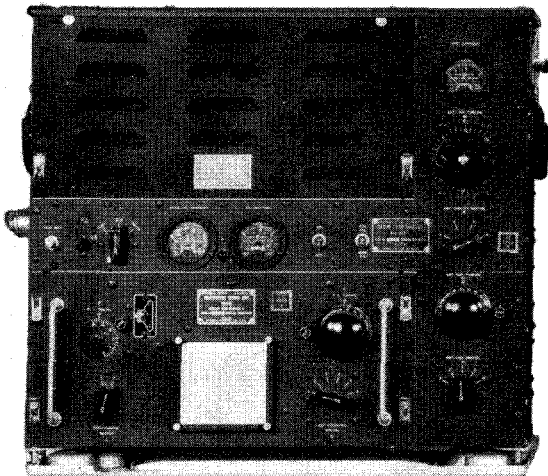

BC-375-C TRANSMITTER

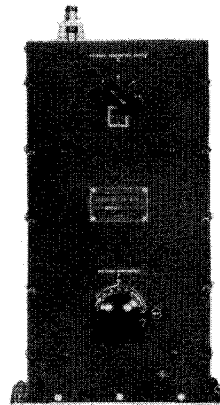

BC-306-A ANTENNA
TUNING UNIT

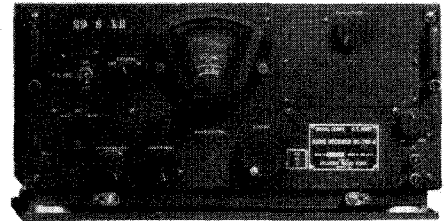

BC-348-H RECEIVER

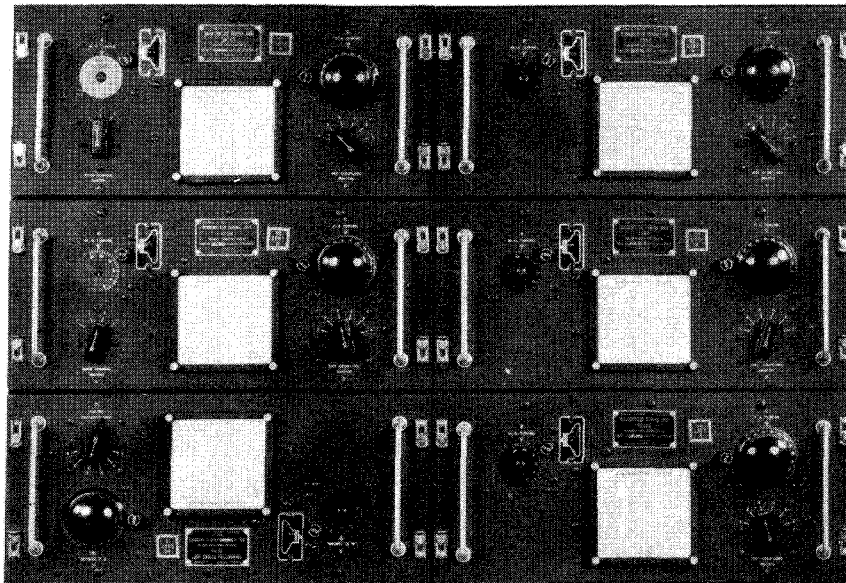

TRANSMITTER TUNING UNITS

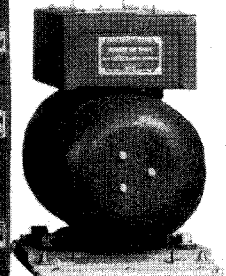

PE-73-C
DYNAMOTOR UNIT

VHF RADIO SET (COMMAND AND LIAISON) SCR-522-A

Principal Components: -

Transmitter - Receiver Assembly	BC-624-A Receiver BC-625-A Transmitter
Radio Control Box	BC-602-A *
Junction Box	JB-29-A
Dynamotor Unit	PE-94-A

Operating Voltage - - - - - 28-v d-c

This set is intended for use in U.S. Army aircraft and will provide two-way radio-telephone communication between aircraft in flight and between aircraft and ground stations. Operation may take place on any of four crystal-controlled channels lying within the frequency range of the equipment. Remote control only is provided.

JB-29-A JUNCTION BOX



BC-602-A RADIO CONTROL BOX

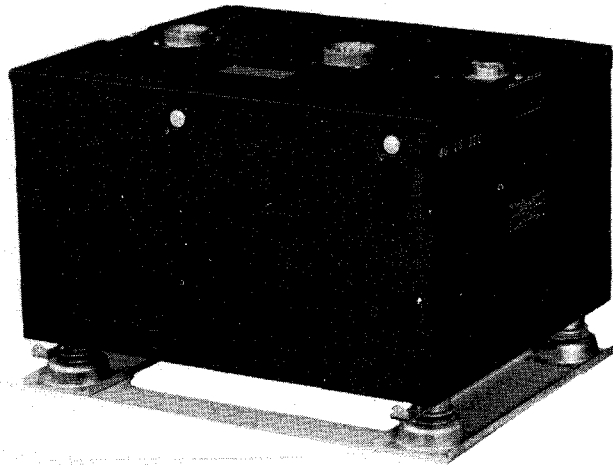

BC-624-A RECEIVER
and
BC-625-A TRANSMITTER

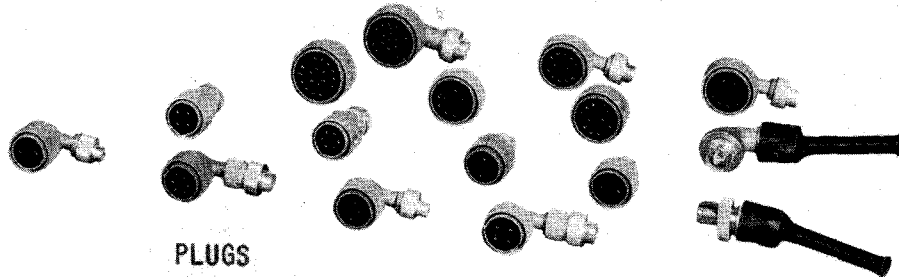

PLUGS

PRINCIPAL COMPONENTS OF
SCR-522-A VHF RADIO SET (COMMAND & LIAISON)

RADIO SET SCR-578-A

(EMERGENCY SEA RESCUE TRANSMITTER--DINGHY SET)

Principal Components: -

Radio Transmitter	BC-778-A
Hand Crank	GC-18-A
Signal Lamp	M-308-A
Kite	M-277-A
Parachute	M-276-A
Accessory Bag	BG-109-A
Balloon	M-278-A
Bag	BG-110-A

Radio set SCR-578-A is a hand powered, emergency transmitter designed for operation in a small boat or life raft. It transmits a MCW signal on a frequency of 500 kilocycles. This radio set is used by personnel in distress on water and provides for automatic transmission of predetermined signal upon which the radio compass of searching parties can "home." This signal can also be keyed manually so as to communicate one's whereabouts to searching parties. No receiver is provided.

The above methods of manual and automatic keying are also used with a signal lamp which can be plugged into a socket on the transmitter case and used for visual signaling. When the signal lamp is used in this manner no radio transmission takes place.

Operational adjustments and tuning of radio set SCR-578-A have been kept to a minimum. Simplicity of operation thus permits inexperienced personnel

having no knowledge of radio or radio transmission to operate this set by merely following the instructions printed on the equipment.

All parts of radio set SCR-578-A are of a rugged construction to withstand rough usage, such as dropping with a parachute. To permit dropping the radio set in this manner, a parachute is permanently attached to the bags containing radio set SCR-578-A.

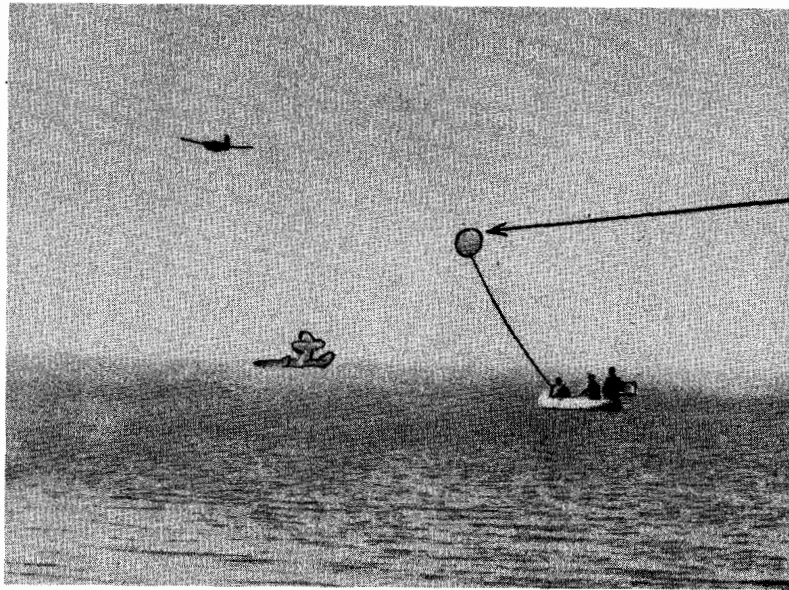

M-278-A BALLOON

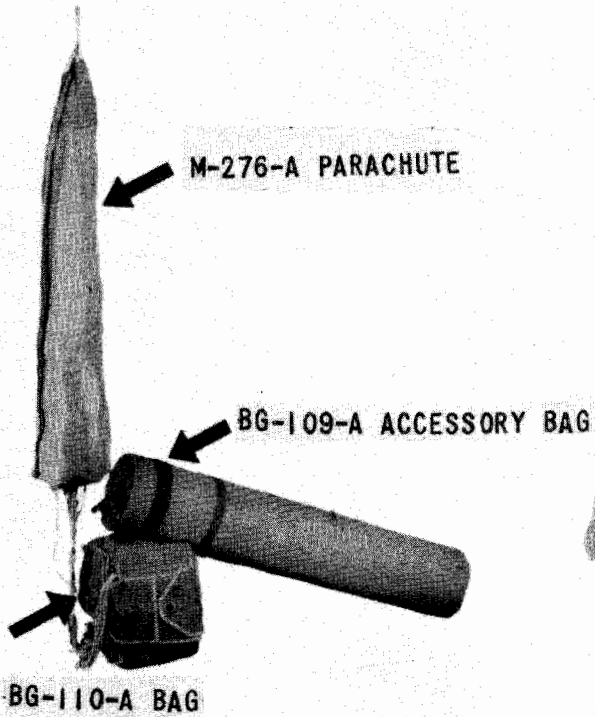

M-276-A PARACHUTE

BG-109-A ACCESSORY BAG

BG-110-A BAG

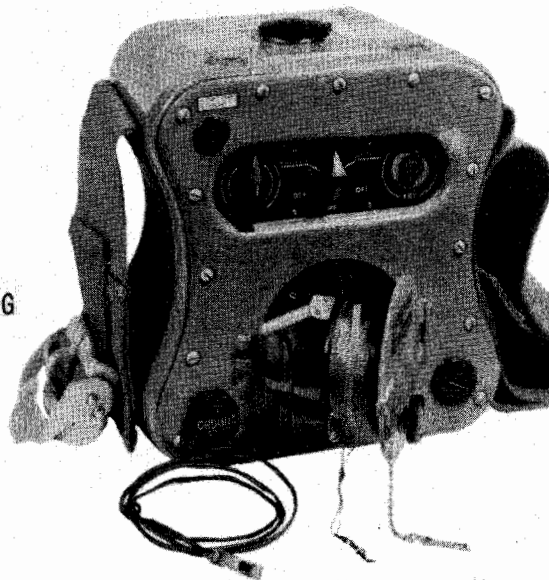

BC-778-A TRANSMITTER

PRINCIPAL COMPONENTS OF
SCR-578-A RADIO SET
(Emergency Sea Rescue Transmitter-Dinghy Set)

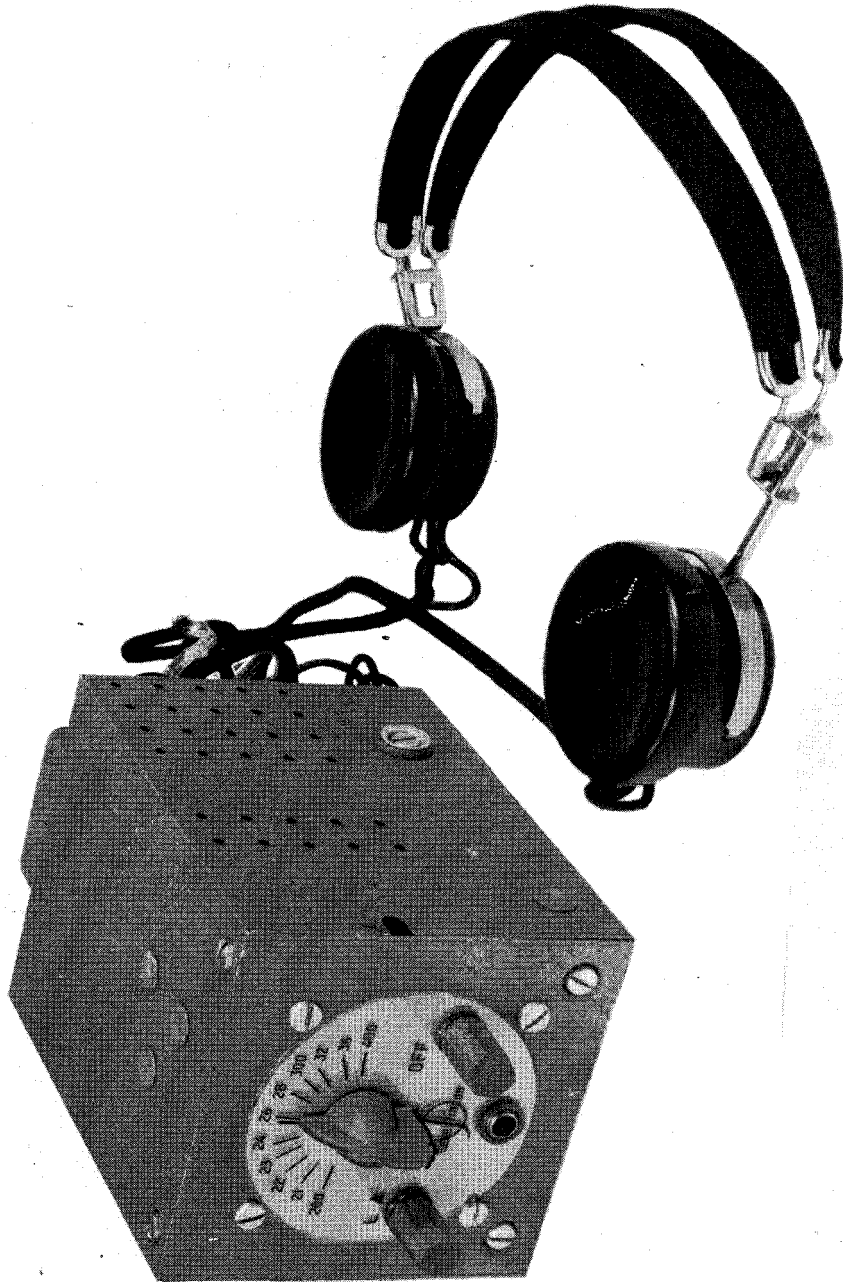

RADIO RANGE RECEIVER & HEADSET
200-400 KC
DETROLA CORP. MODEL 438

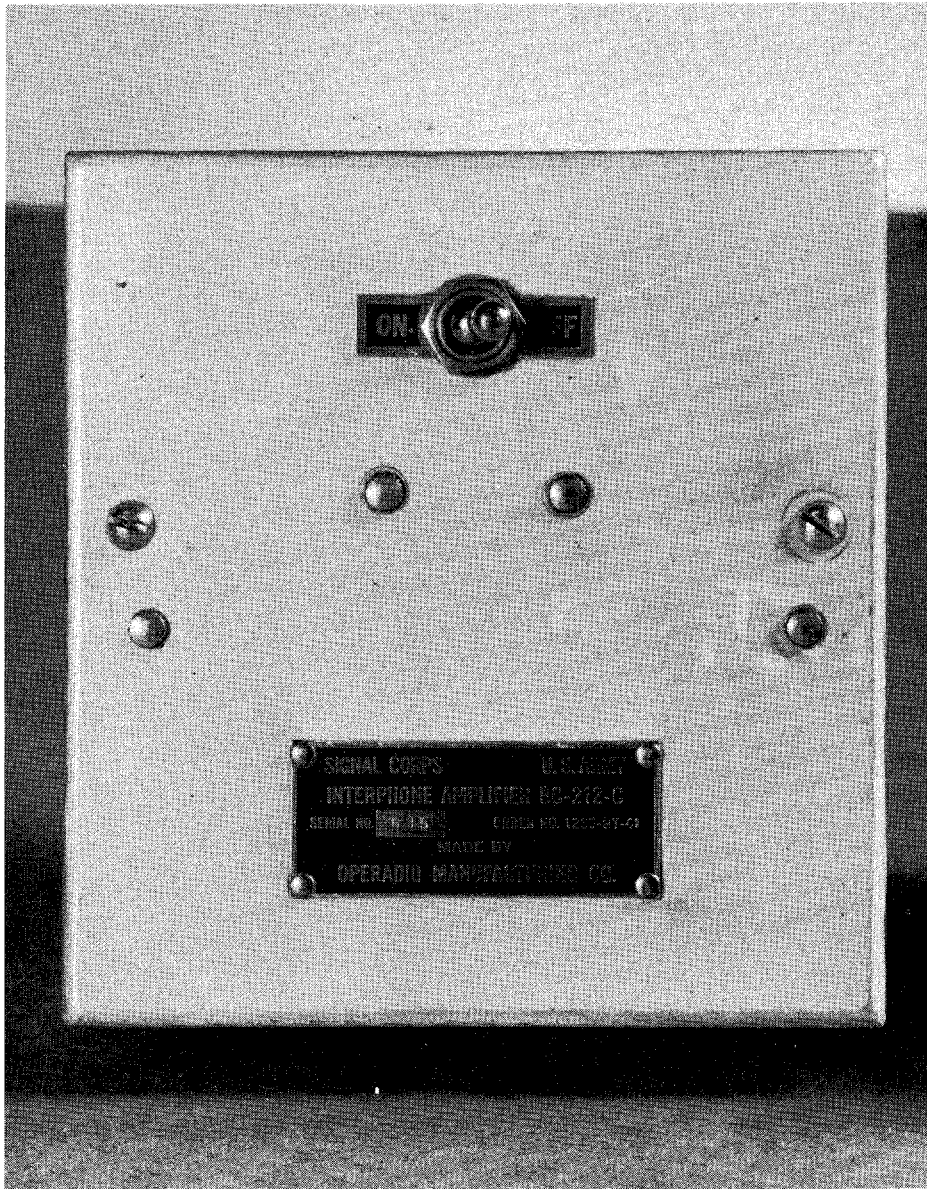

BC-212-C INTERPHONE AMPLIFIER
PART OF RC-45 INTERPHONE EQUIPMENT

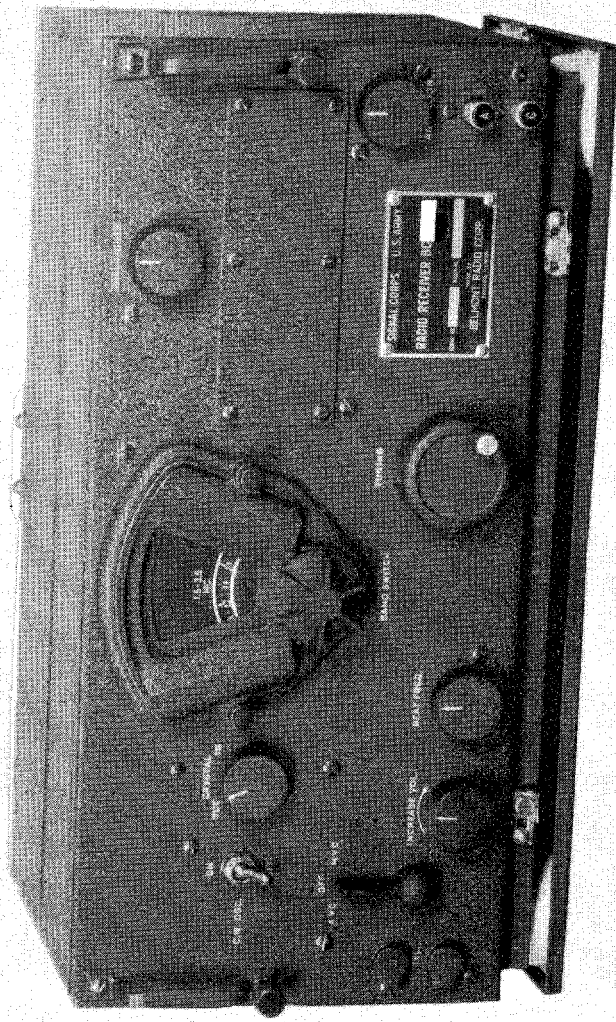

RADIO RECEIVER BC-224-F PART OF RADIO SET SCR-187-A

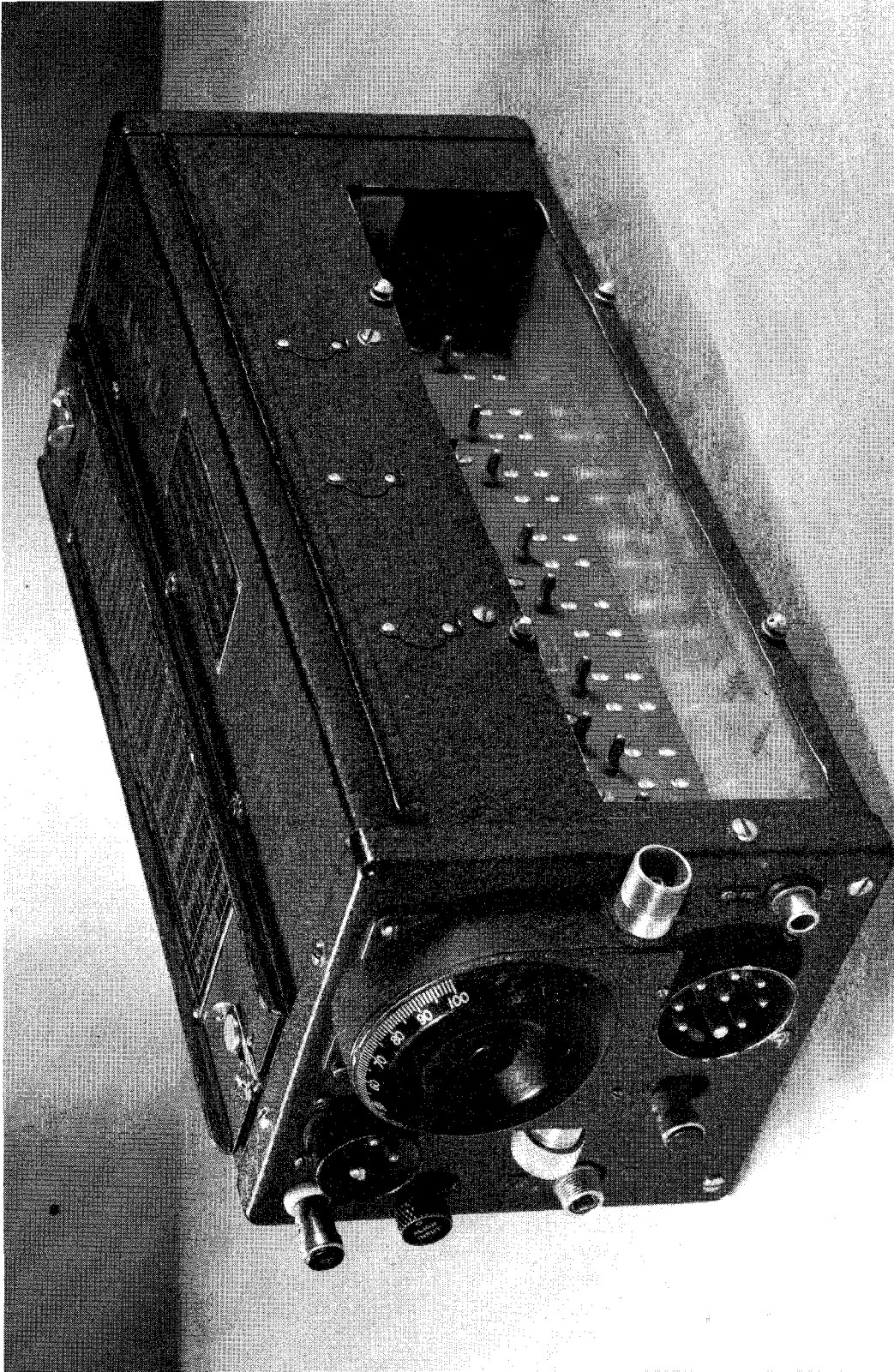

BC-AH-229 RADIO RECEIVER PART OF RADIO SET SCR-AJ-183

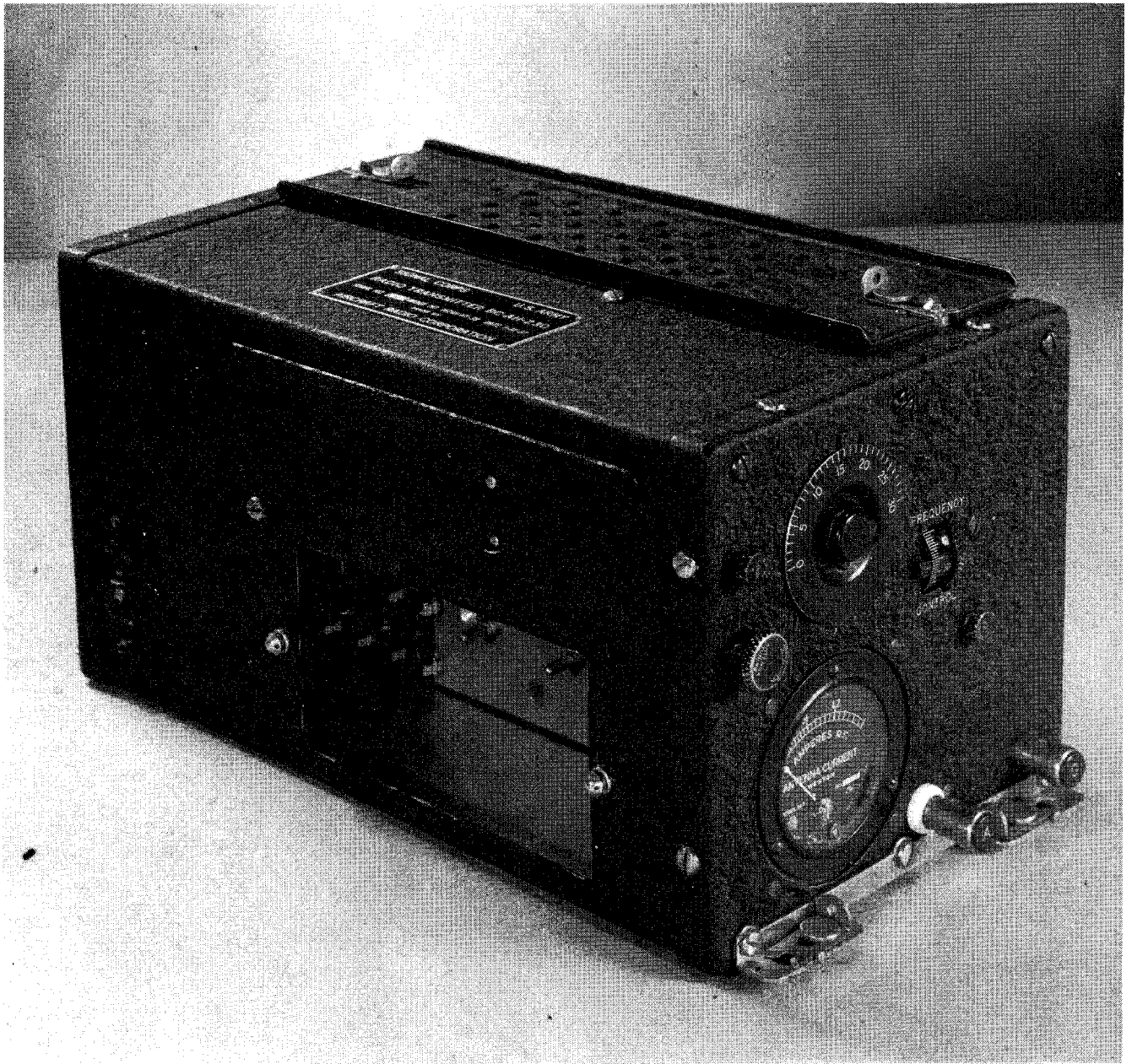

BC-AH-230 RADIO TRANSMITTER PART OF RADIO SET SCR-AJ-183

BC-AH-231 RADIO CONTROL BOX
RECEIVER

PART OF RADIO SET SCR-AJ-183

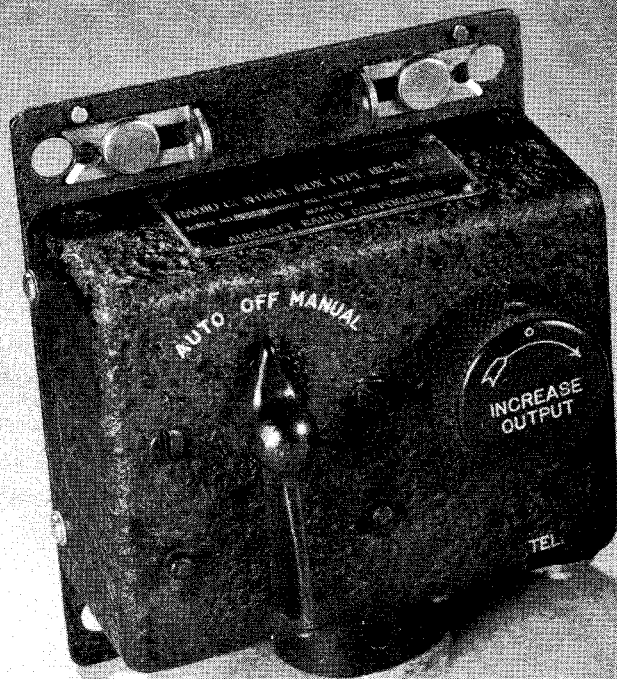

BC-AE-232 RADIO CONTROL BOX
TRANSMITTER

PART OF RADIO SET SCR-AJ-183



BC-306-A ANTENNA TUNING UNIT





BC-309 RADIO CONTROL BOX



BC-341-B MARKER BEACON RADIO RECEIVER PART OF RC-39-A

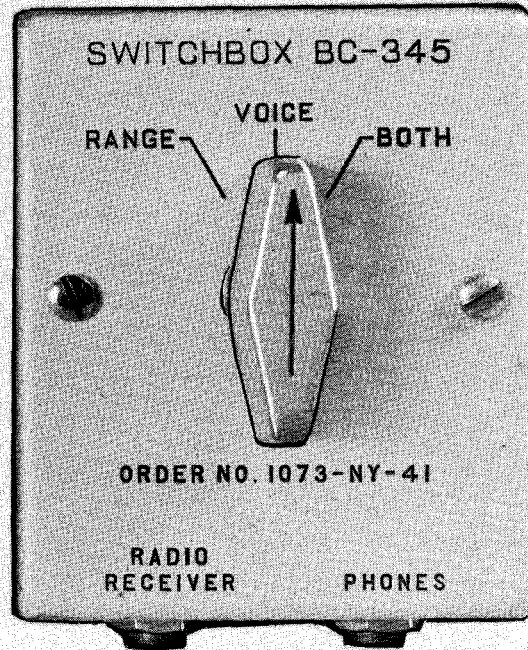

BC-345 FILTER SWITCH BOX PART OF RC-32

BC-348-H RADIO RECEIVER PART OF SCR-287-A



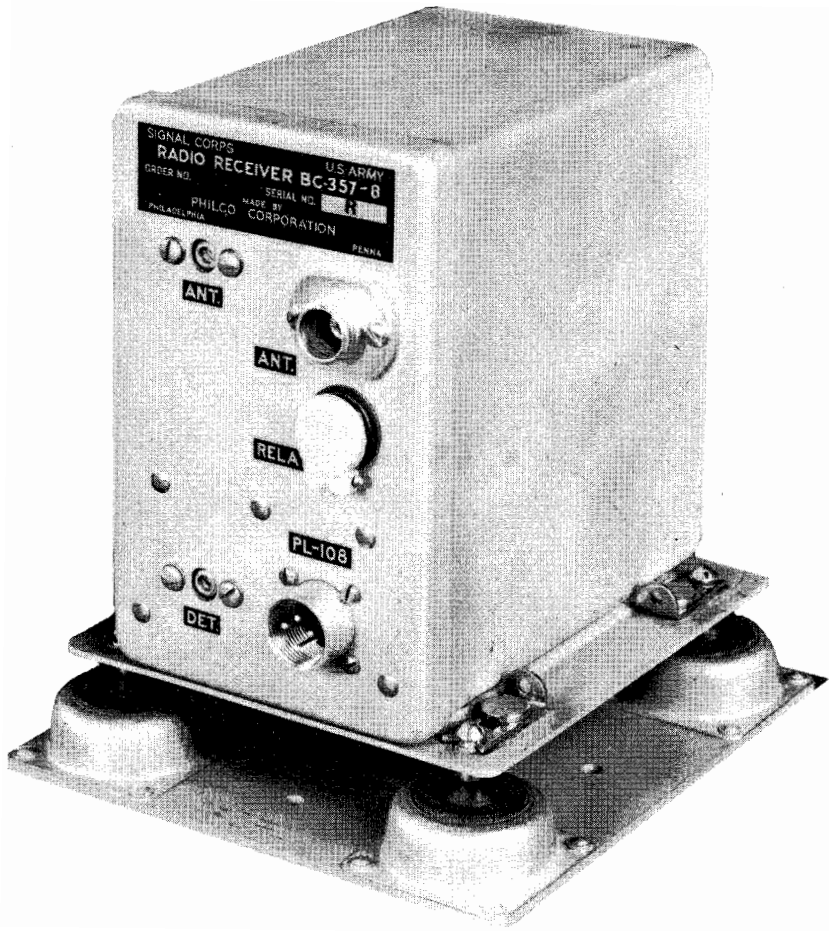

**BC-357-B MARKER BEACON RADIO RECEIVER
PART OF RC-43-A**



BC-375-C RADIO TRANSMITTER PART OF SCR-287-A

BC-431-A COMPASS RADIO RECEIVER PART OF SCR-280-A



FREQUENCY DIAL: Turn tuning crank around and align end of (800-1750) dial with mark. Check that beneath each radio control dial are respective tuning and crank dials. Notch reference line and crank dial. Remove loop detune cap. Push loop detune knob and rotate cap until detune pointer is not exactly in center of bearing indicator. Disconnect and reconnect.

INSTALLATION ADJUSTMENTS

THRESHOLD SENSITIVITY: Switch to ANT. Turn tuning knob until signal near 800 Hz. Where no signal is received, adjust THRES. SENS. to obtain a signal. Repeat this procedure for each band. To obtain a certain amount of loop gain, switch to COMP. Turn to signal near 800 Hz. Adjust COMPASS INDICATOR SWING OF COMPASS INDICATOR. Adjust LOOP GAIN FOR MAINLINE REFLECTION OF COMPASS INDICATOR. REEZE.

SIGNAL CORPS
U.S. ARMY
RADIO COMPASS UNIT BC-431-A
MADE IN THE U.S.A.
RECEIVER



BC-432-B RADIO COMPASS CONTROL BOX PART OF SCR-280-A



RADIO COMPASS UNIT BC-433-G PART OF SCR-269-G



BC-434-A RADIO COMPASS CONTROL BOX PART OF SCR-269-G

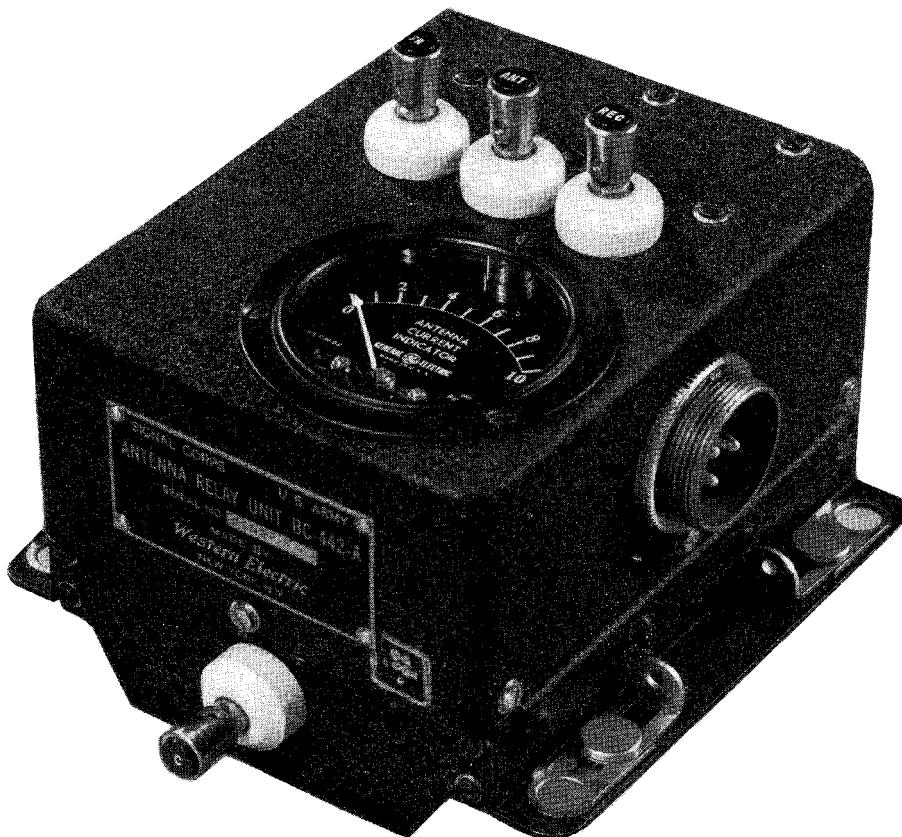

BC-442-A ANTENNA RELAY UNIT PART OF SCR-274-N

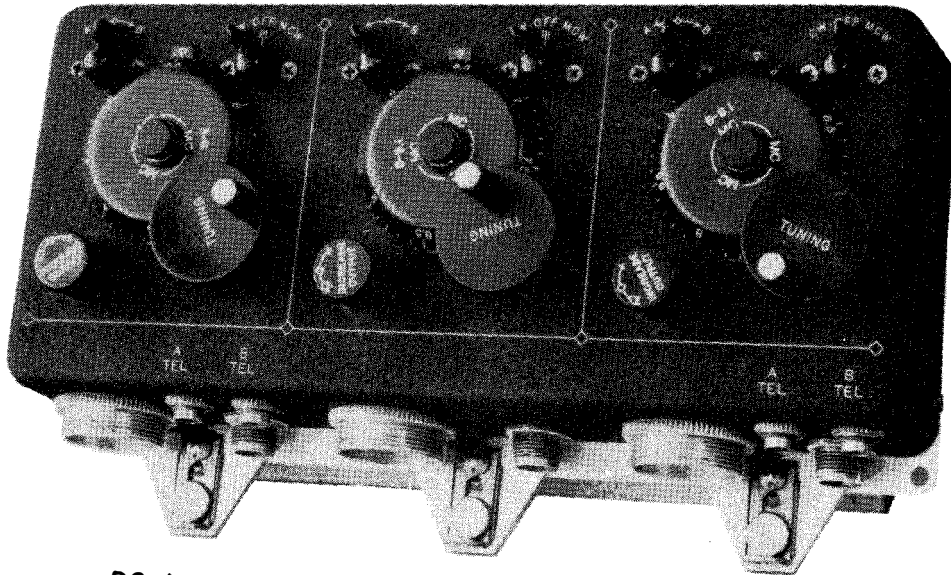

BC-450-A RADIO RECEIVER CONTROL BOX
PART OF SCR-274-N



BC-451-A RADIO TRANSMITTER CONTROL BOX
PART OF SCR-274-N

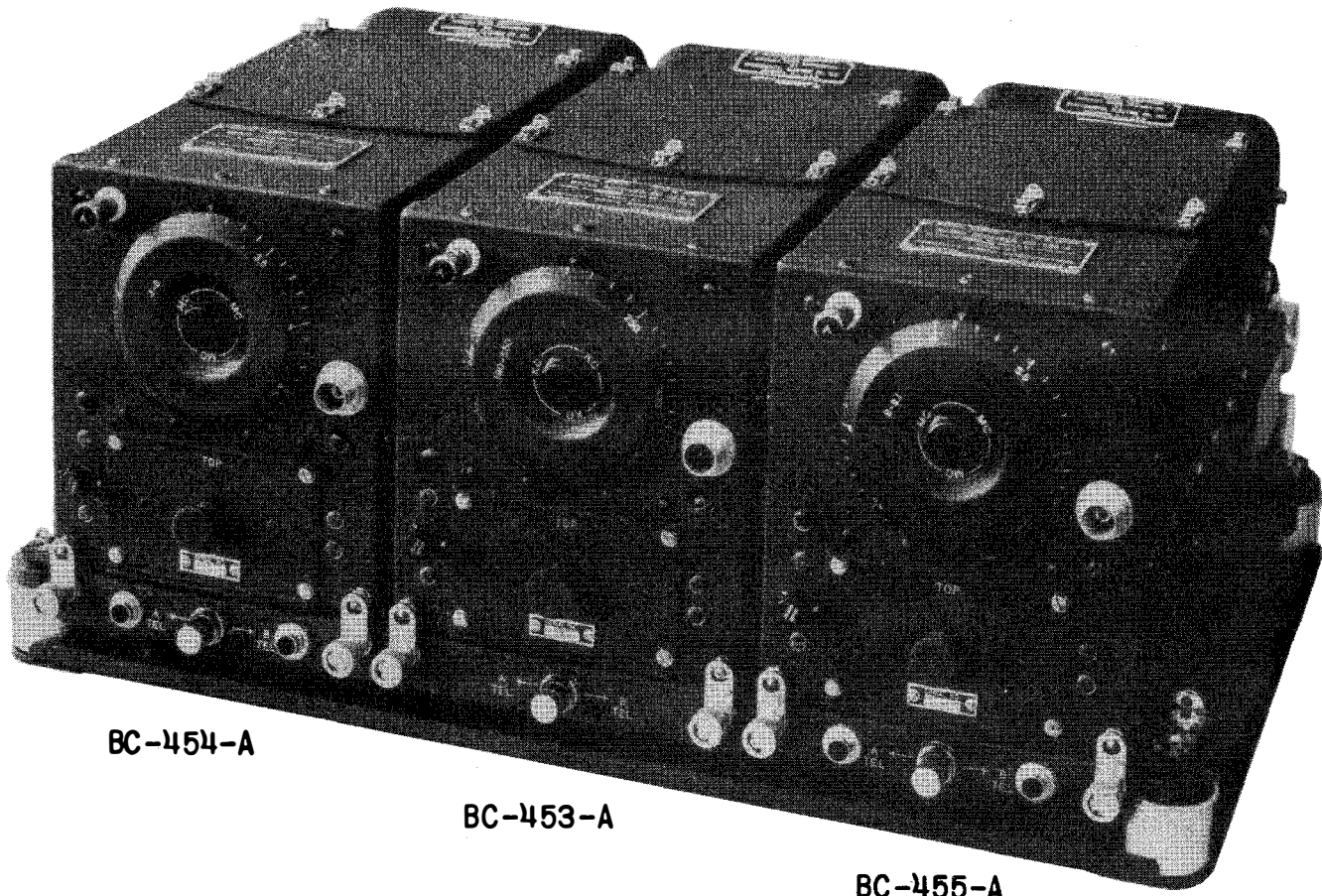

BC-454-A

BC-453-A

BC-455-A

BC-454-A, BC-453-A, BC-455-A COMMAND RADIO RECEIVERS
PART OF SCR-274-N

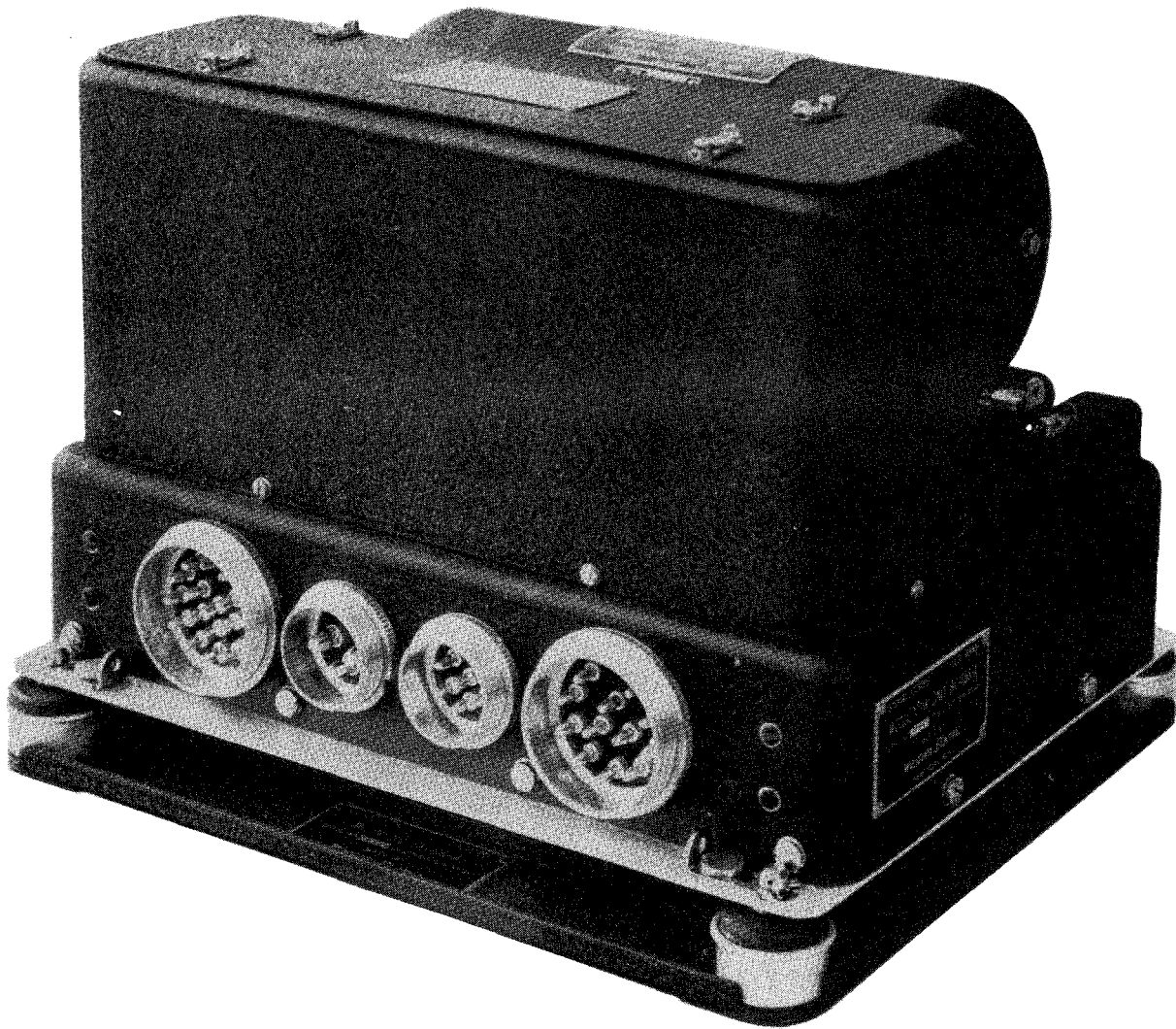

BC-456-A MODULATOR UNIT---POWER SUPPLY---PART OF SCR-274-N

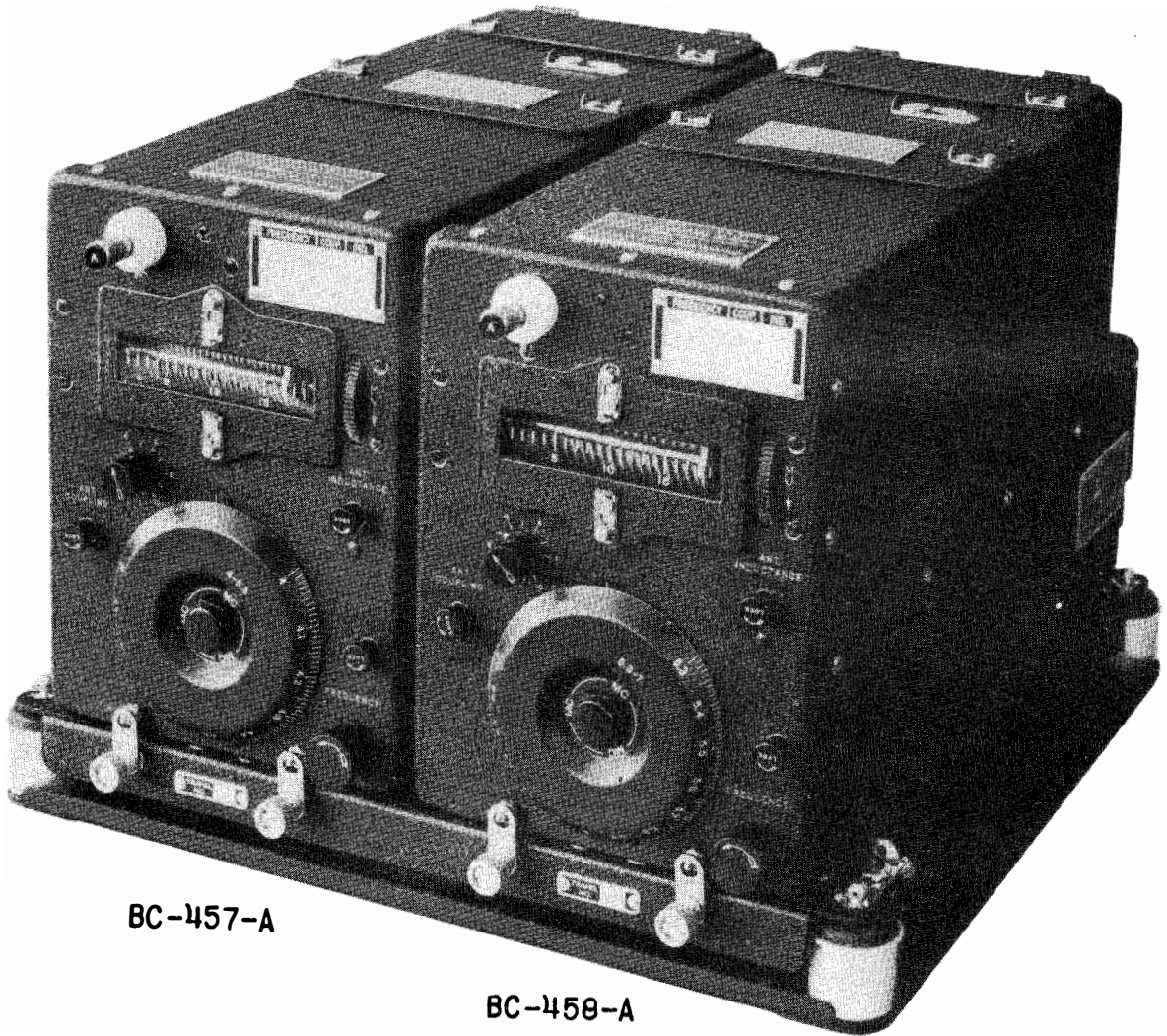

BC-457-A

BC-459-A

BC-457-A AND BC-459-A COMMAND TRANSMITTERS
PART OF SCR-274-N

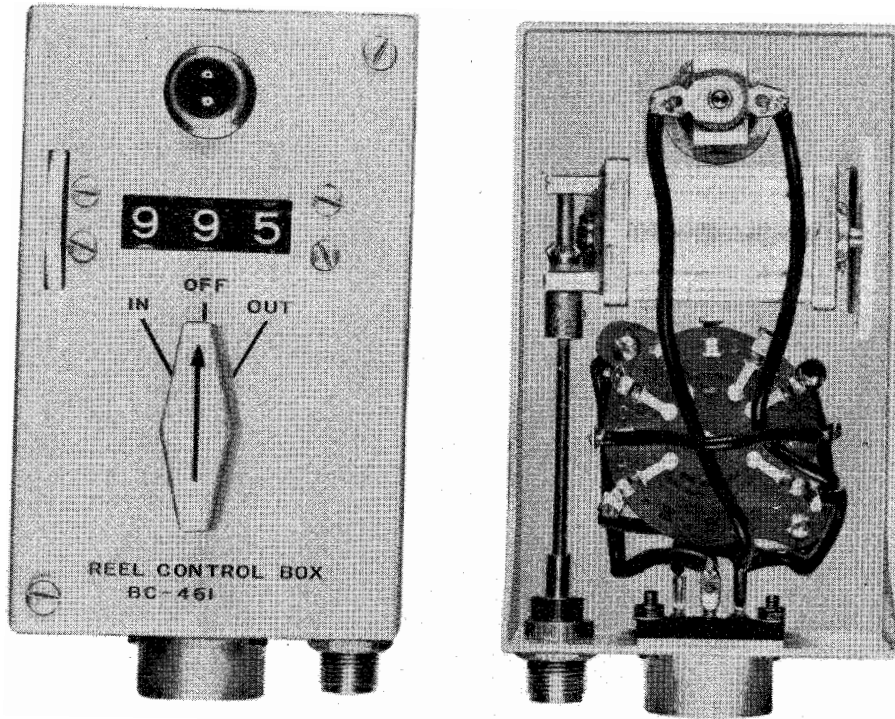

BC-461 REEL CONTROL BOX PART OF SCR-287-A

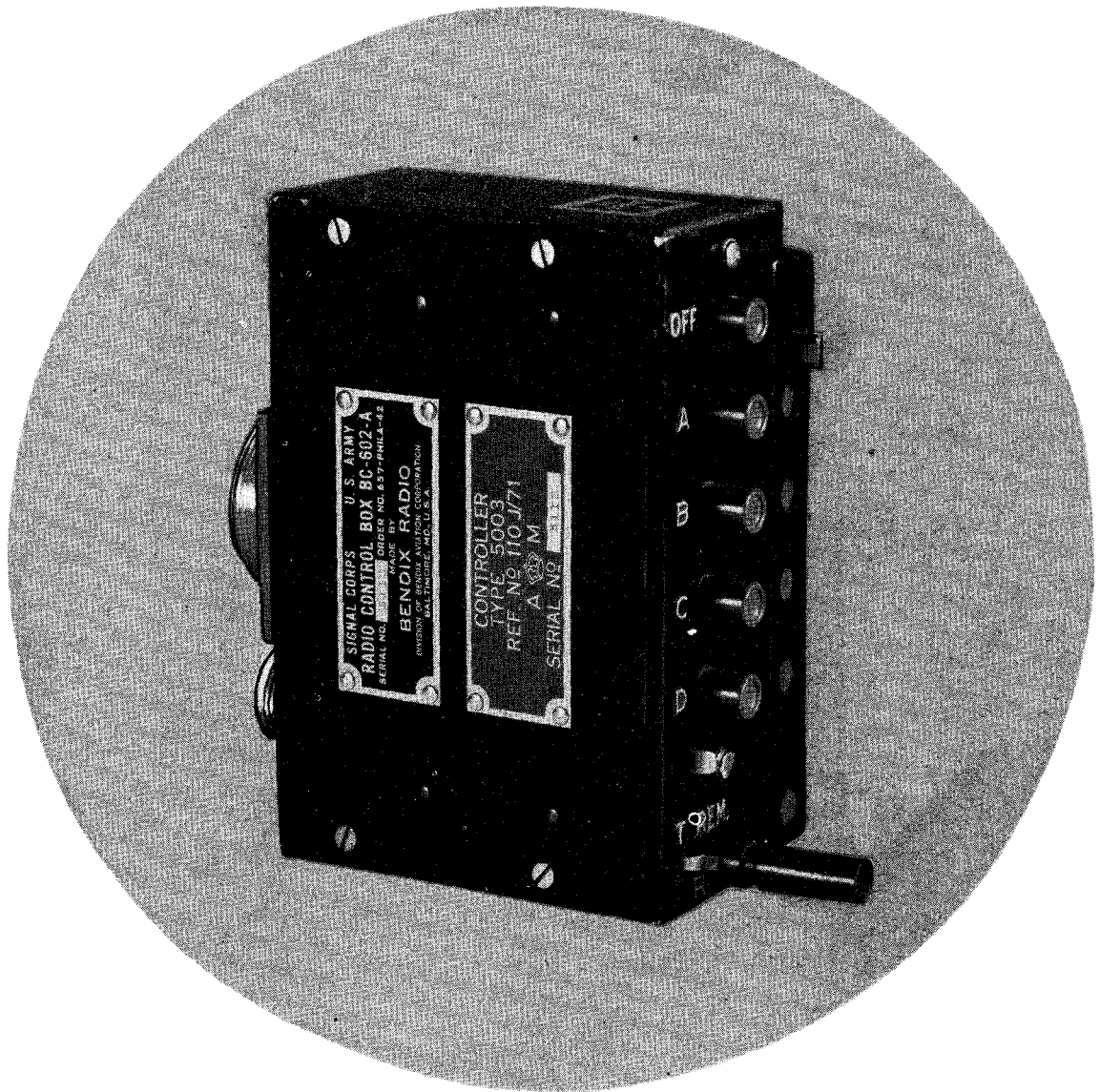

BC-602-A VHF RADIO TRANSMITTER-RECEIVER CONTROL BOX
PART OF SCR-522-A

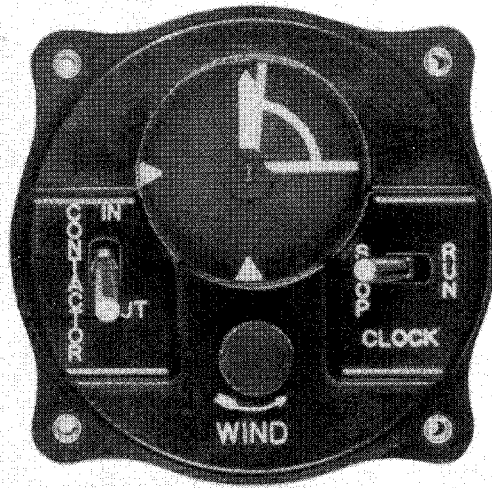
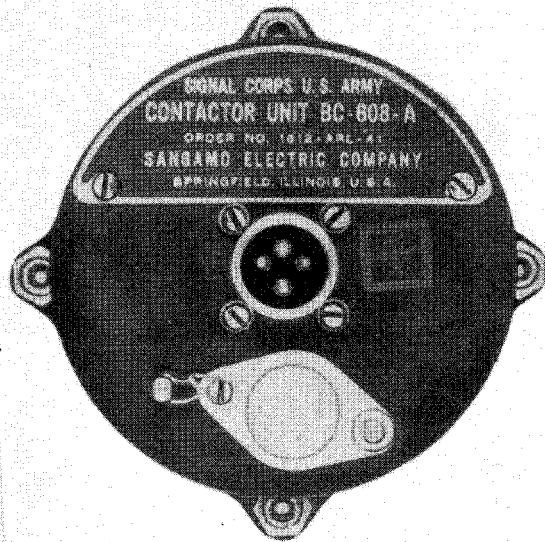

BC-608-A CONTACTOR UNIT
PART OF RC-96 CONTACTOR EQUIPMENT

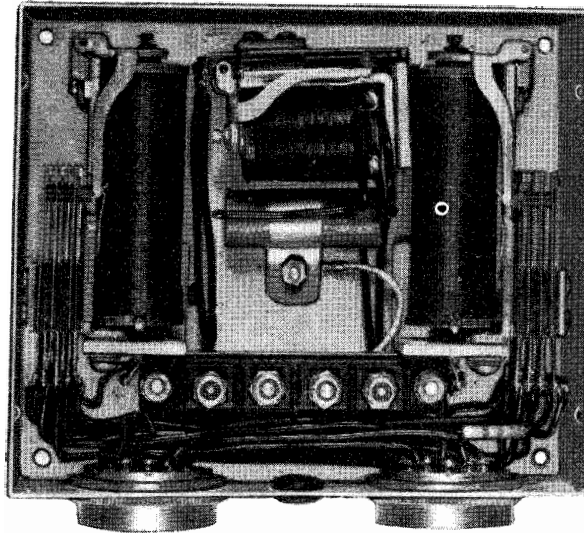
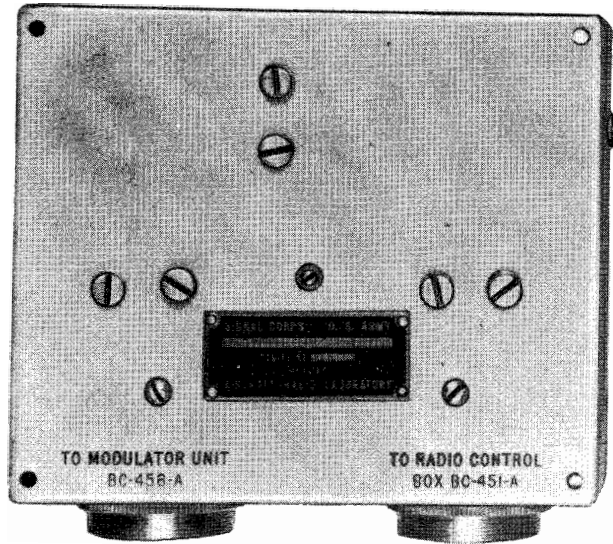

BC-616 RELAY CONTROL BOX PART OF RC-96

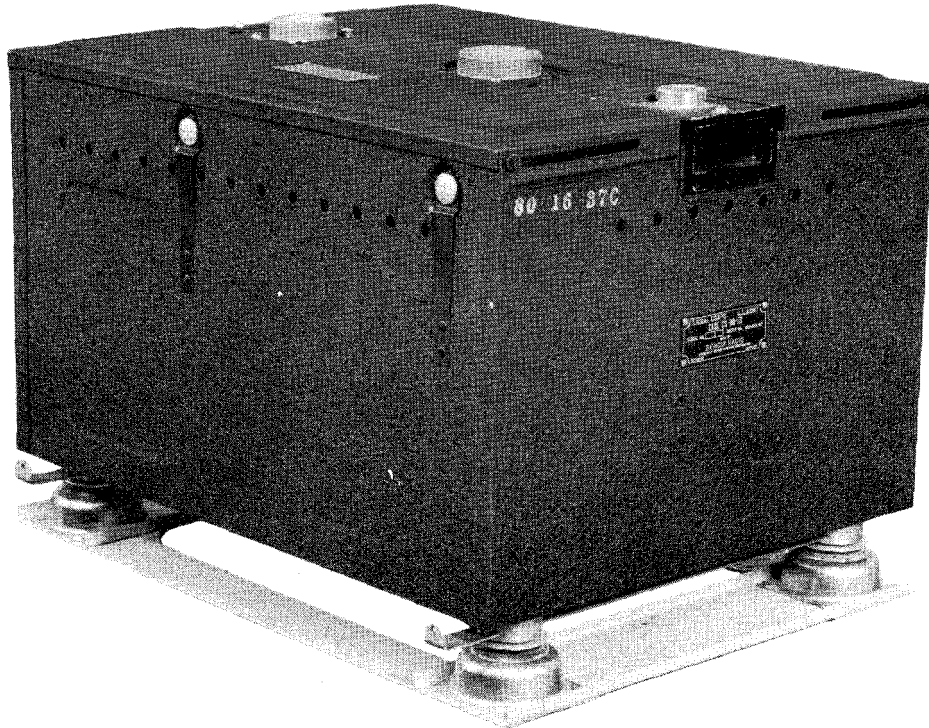

BC-624-A & BC-625-A VHF RADIO TRANSMITTER-RECEIVER ASSEMBLY
PART OF SCR-522-A

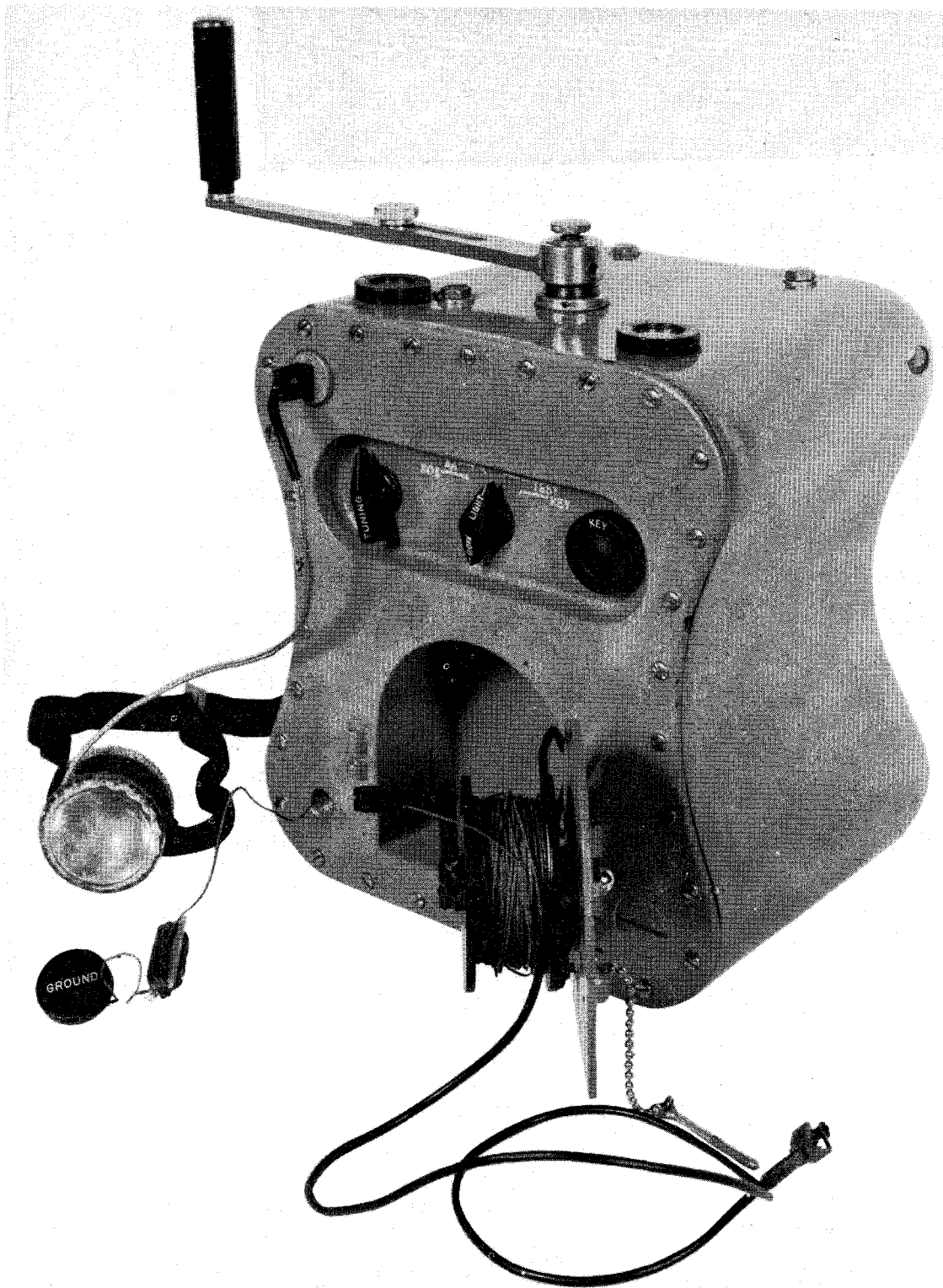

BC-778-A RADIO TRANSMITTER PART OF SCR-578-A
SEA RESCUE TRANSMITTER

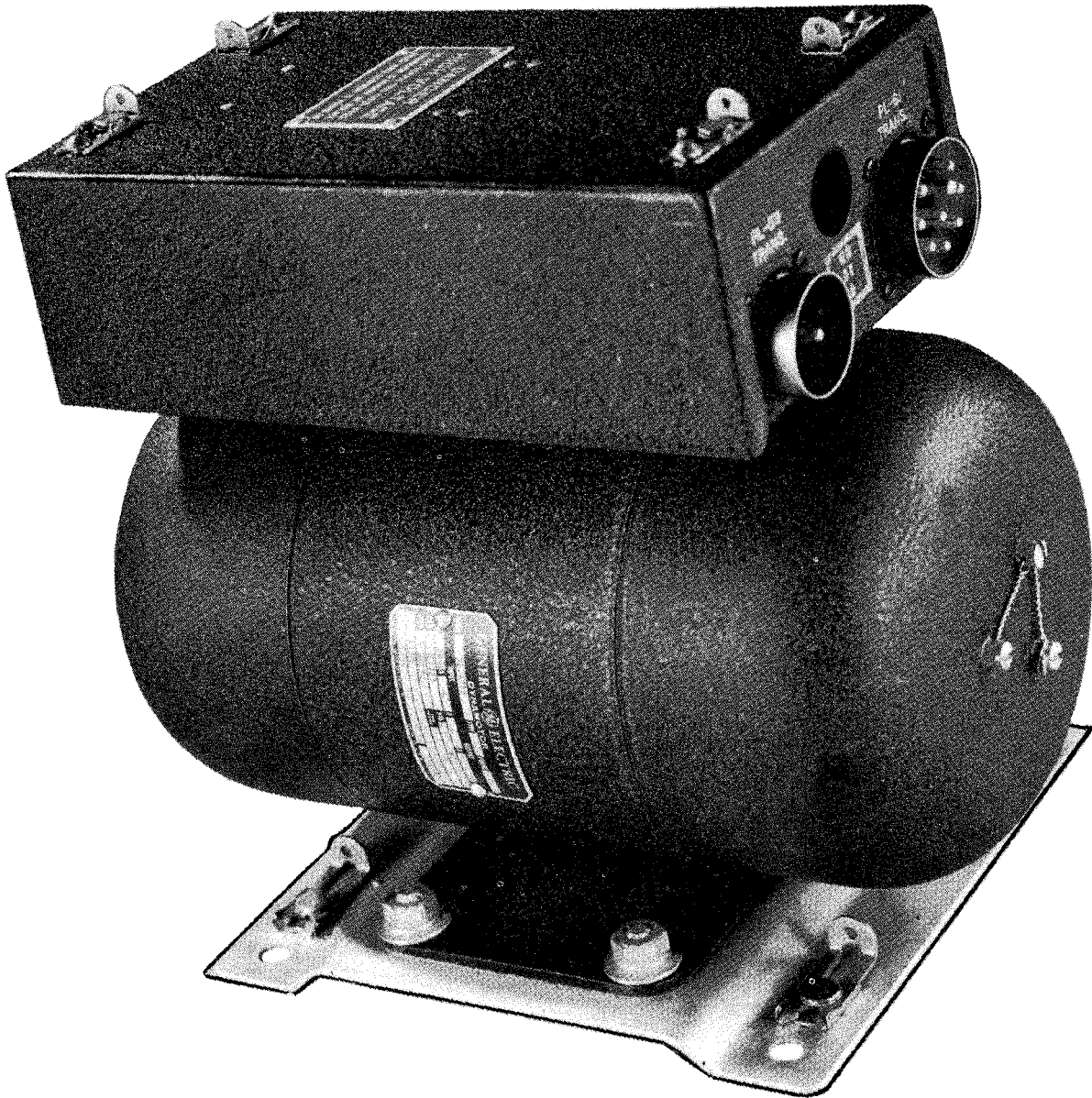

BD-77-D DYNAMOTOR UNIT PART OF SCR-187-A



BD-AG-83 DYNAMOTOR UNIT PART OF SCR-AJ-183

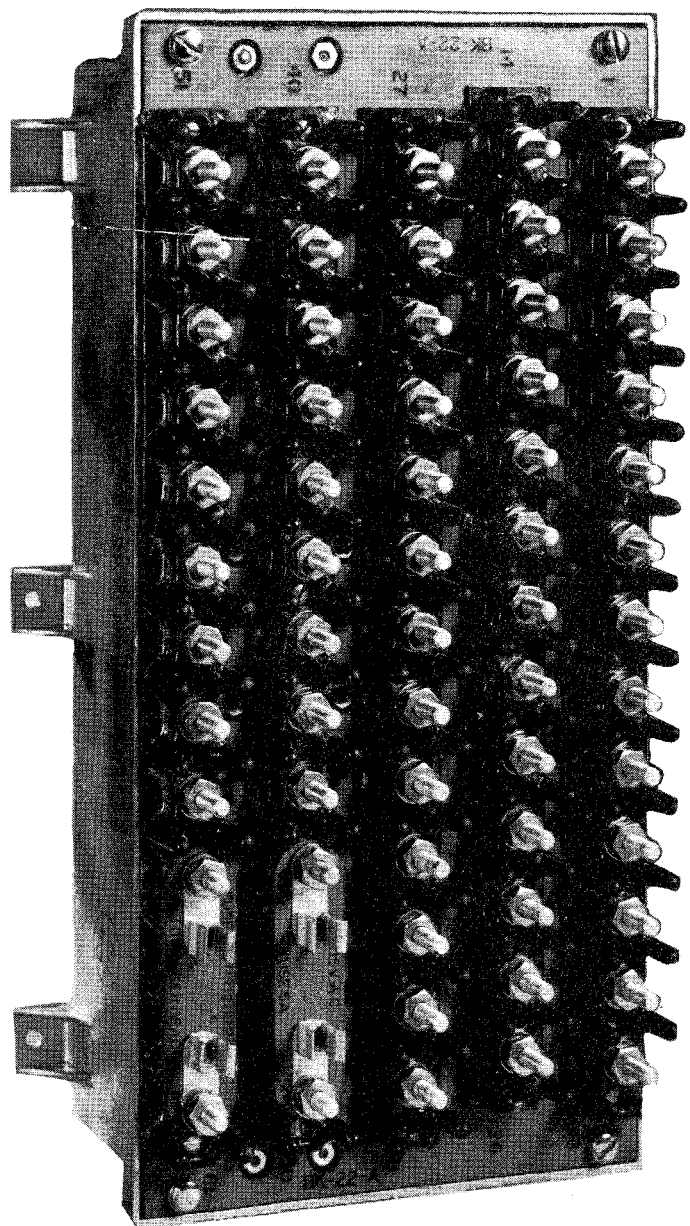

BK-22-A RELAY
PART OF SCR-269-G

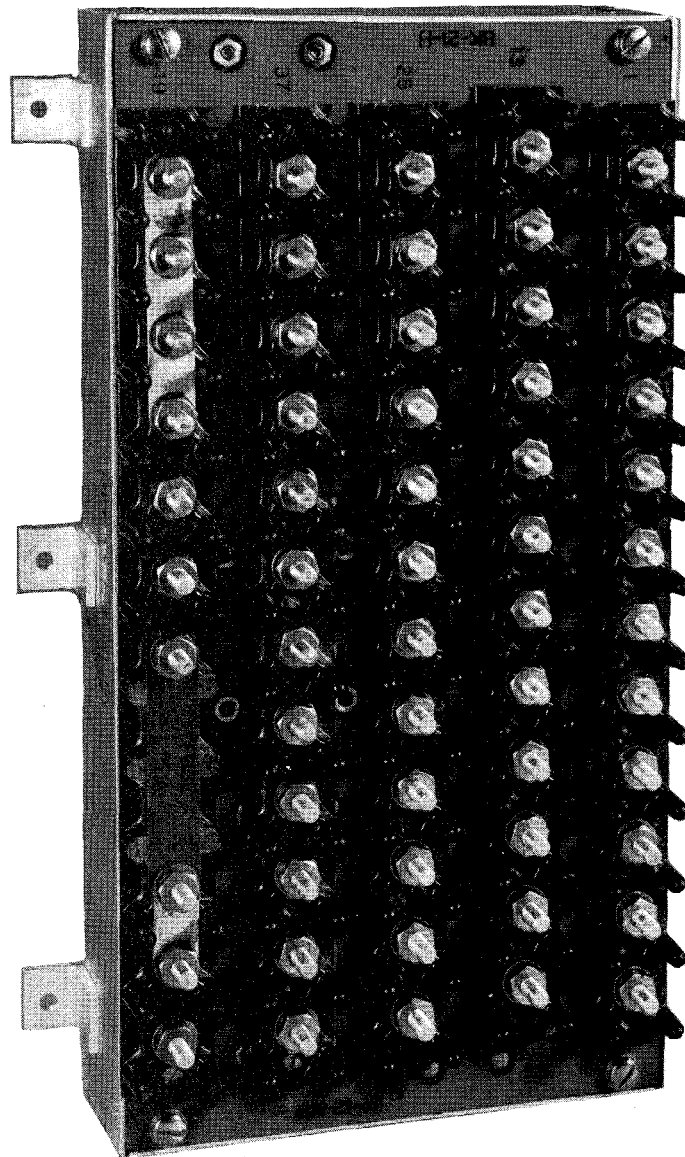

BK-21-B RELAY
PART OF SCR-280-A

C-218 TRANSMITTER COIL SET
PART OF SCR-AJ-183



C-155-A DUAL RANGE RECEIVER COIL SET
PART OF SCR-AJ-183

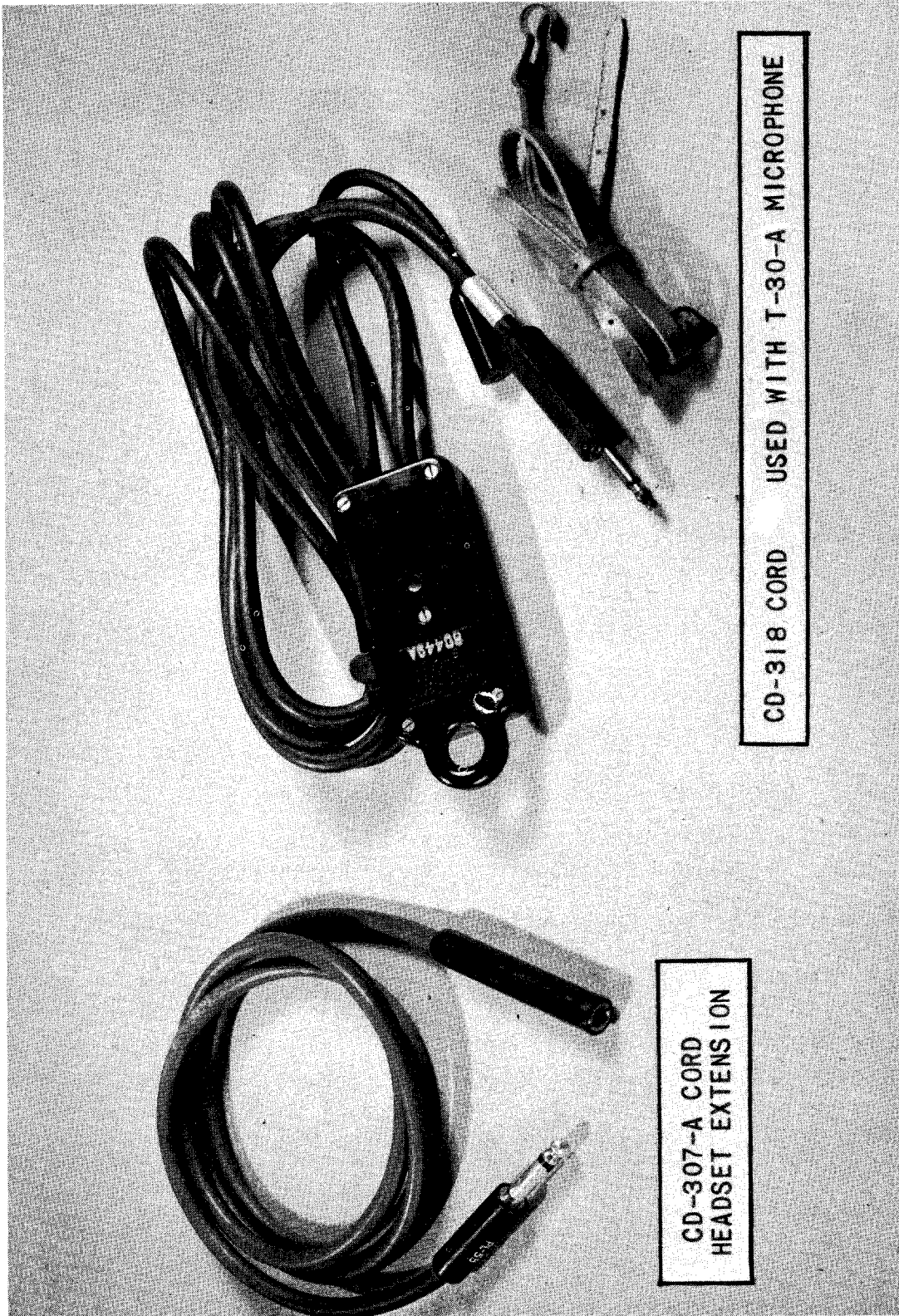

CD-318 CORD USED WITH T-30-A MICROPHONE

CD-307-A CORD
HEADSET EXTENSION

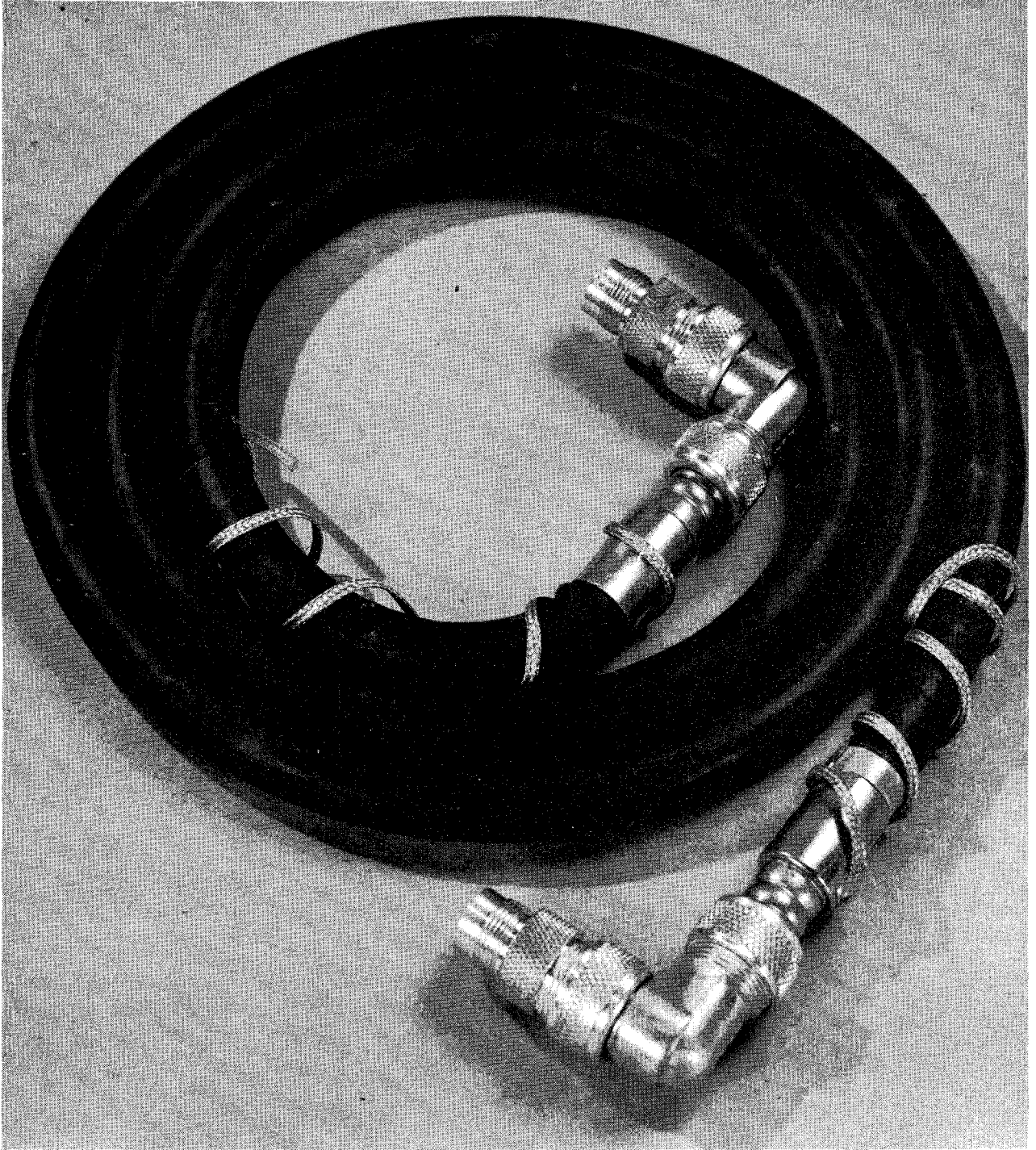

CD-365 CORD PART OF SCR-269-G



DC-9-N CRYSTAL UNIT PART OF SCR-211-N

DM-28-C DYNAMOTOR
PART OF RADIO RECEIVER BC-348-C

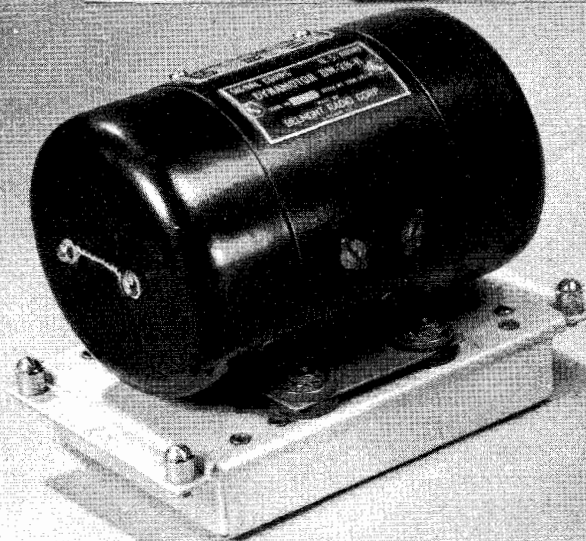

DM-28-H DYNAMOTOR
PART OF RADIO RECEIVER BC-348-H

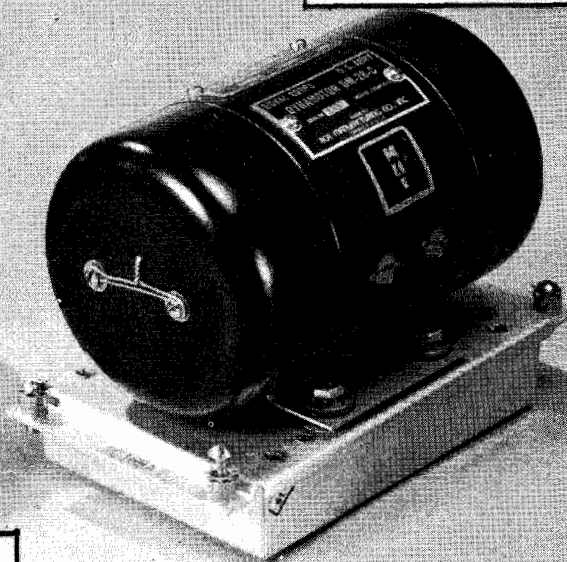

DM-20-A DYNAMOTOR
PART OF BC-431-A COMPASS UNIT

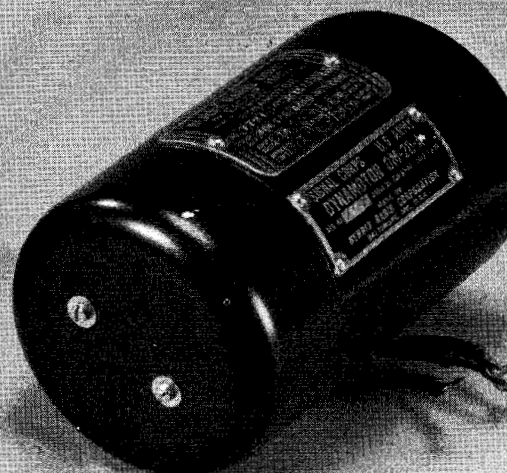

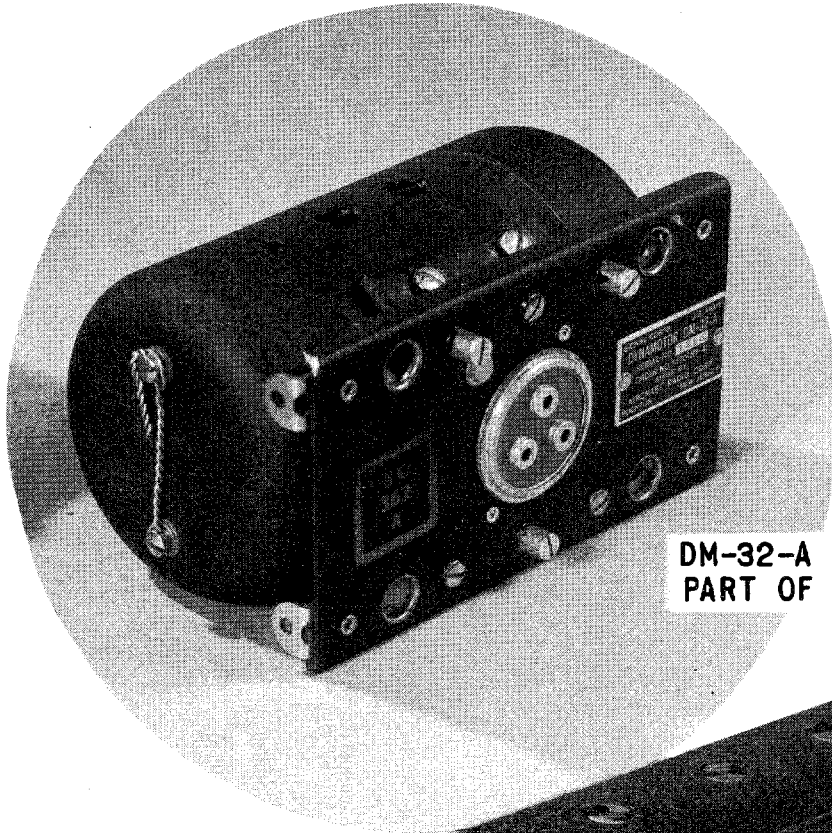

**DM-32-A DYNAMOTOR
PART OF RADIO SET SCR-274-N**

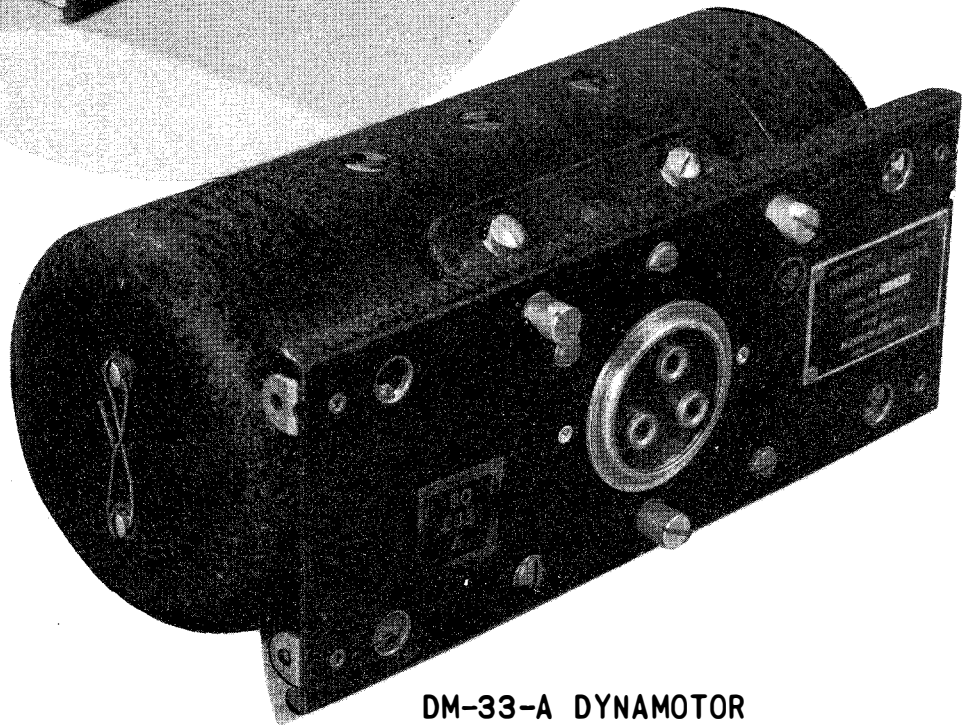

**DM-33-A DYNAMOTOR
PART OF RADIO SET SCR-274-N**

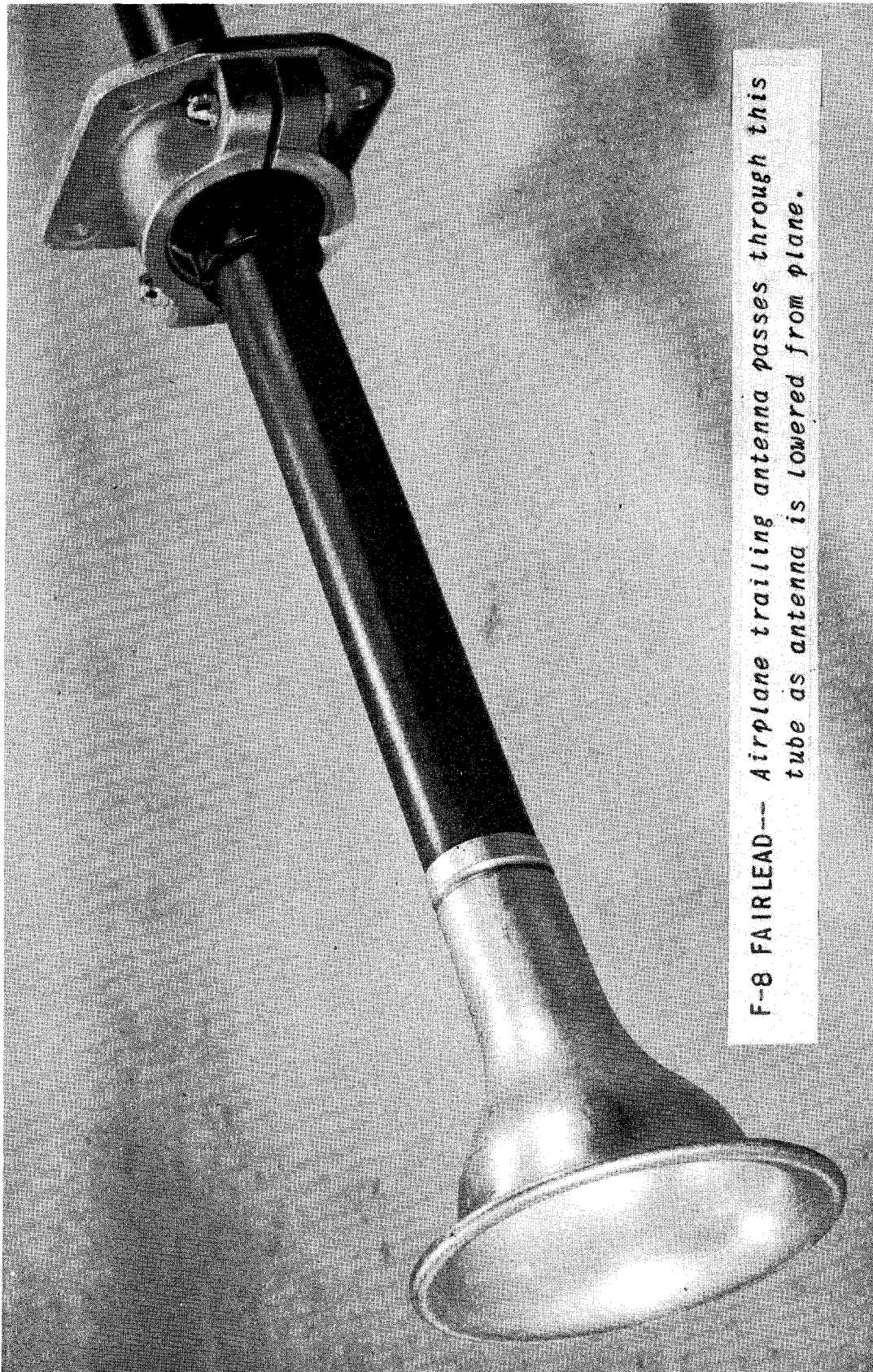

F-8 FAIRLEAD-- Airplane trailing antenna passes through this tube as antenna is lowered from plane.

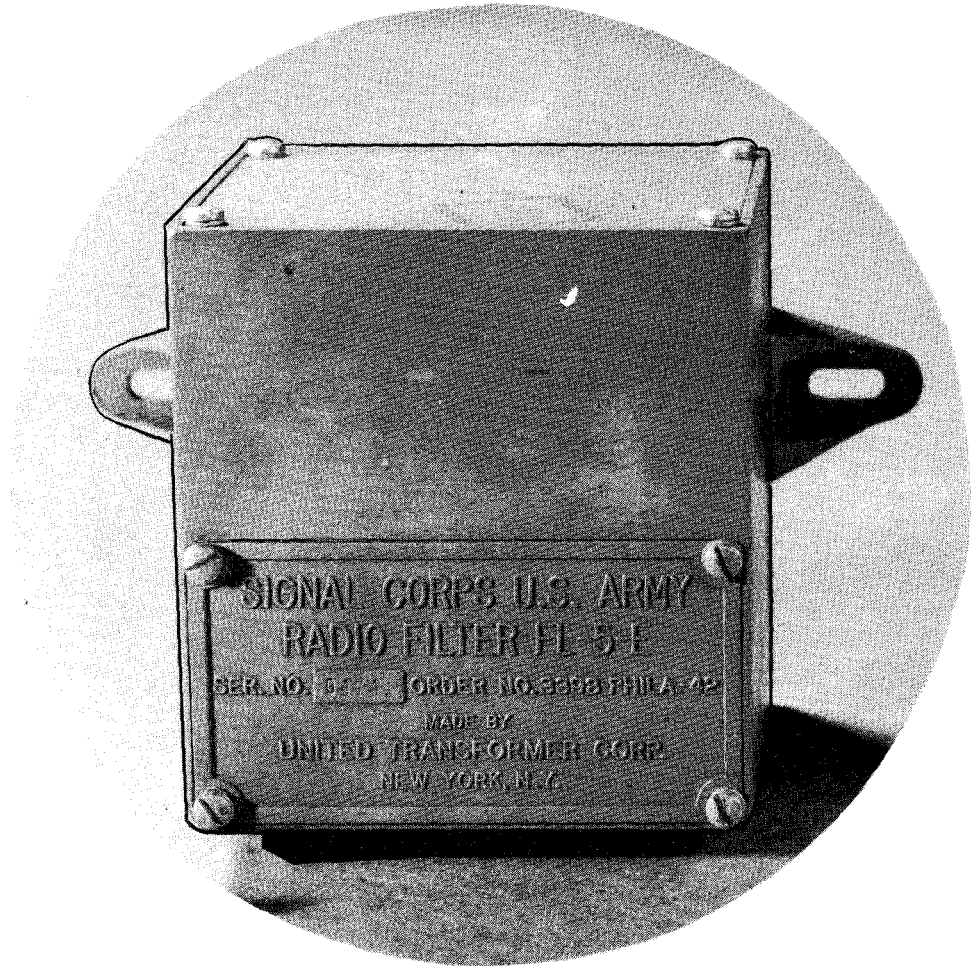

FL-5-E RADIO FILTER PART OF RC-32

MOUNTING FT-213-A

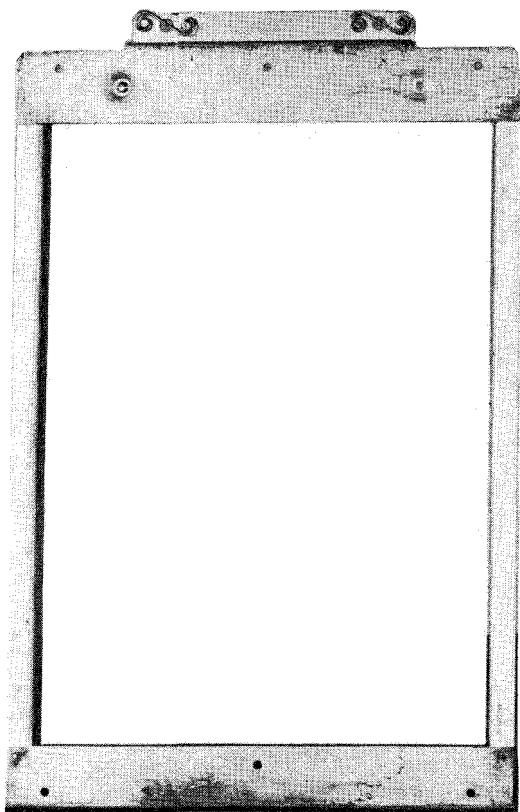

SHOCK MOUNTING SUB-BASE

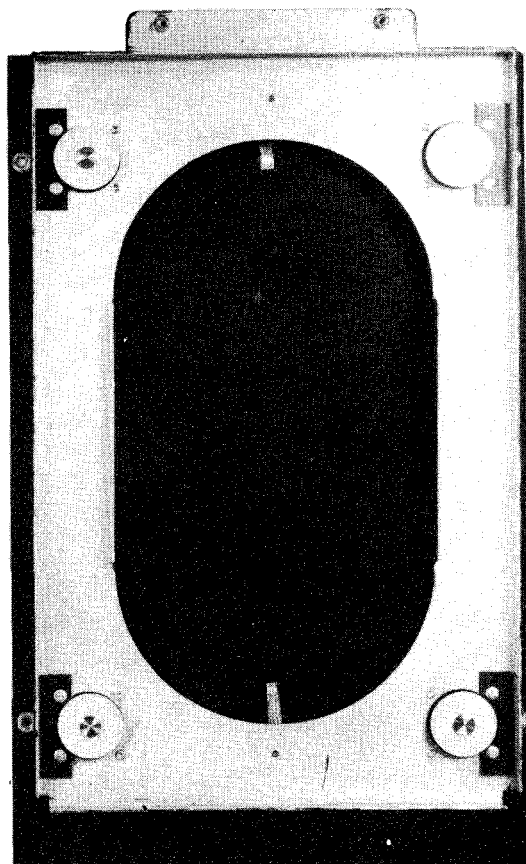

FT-213-A MOUNTING AND SHOCK MOUNTING SUB-BASE;
PART OF RADIO COMPASS UNIT BC-433-F

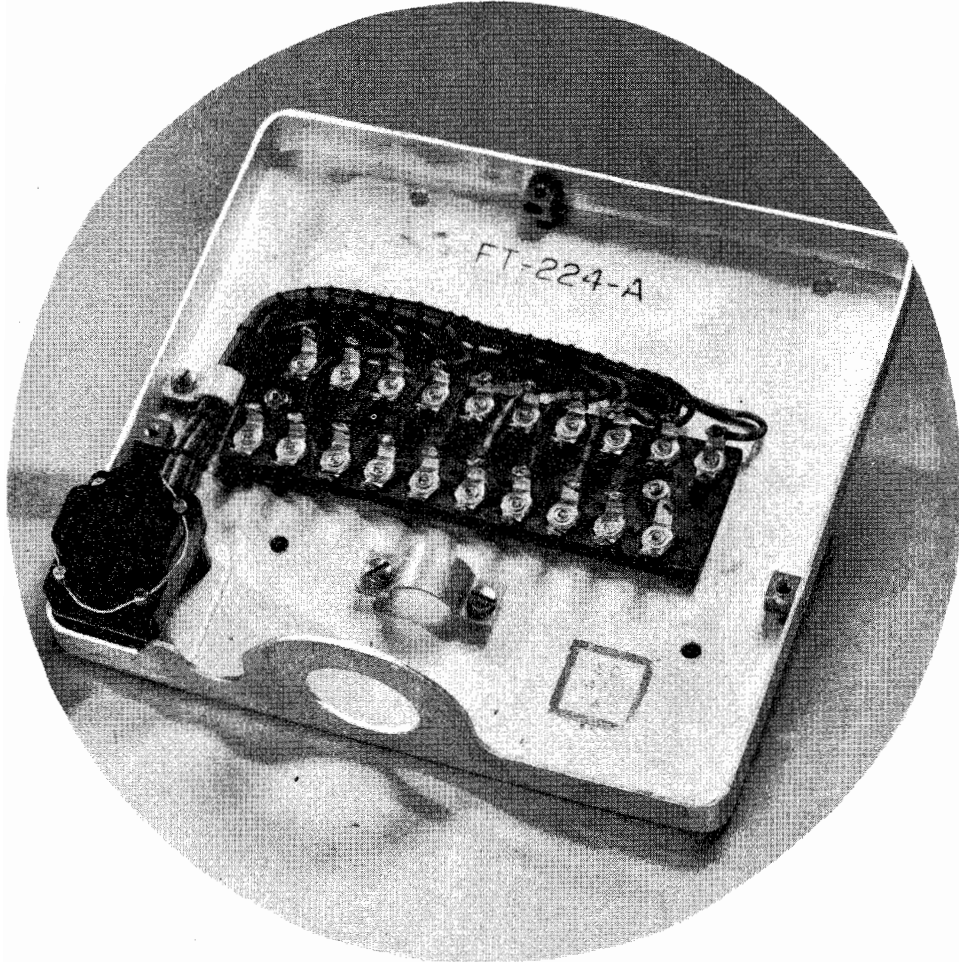

FT-224-A MOUNTING PART OF RADIO CONTROL BOX BC-434-A

LM-58-A LAMP
PART OF SCR-578-A

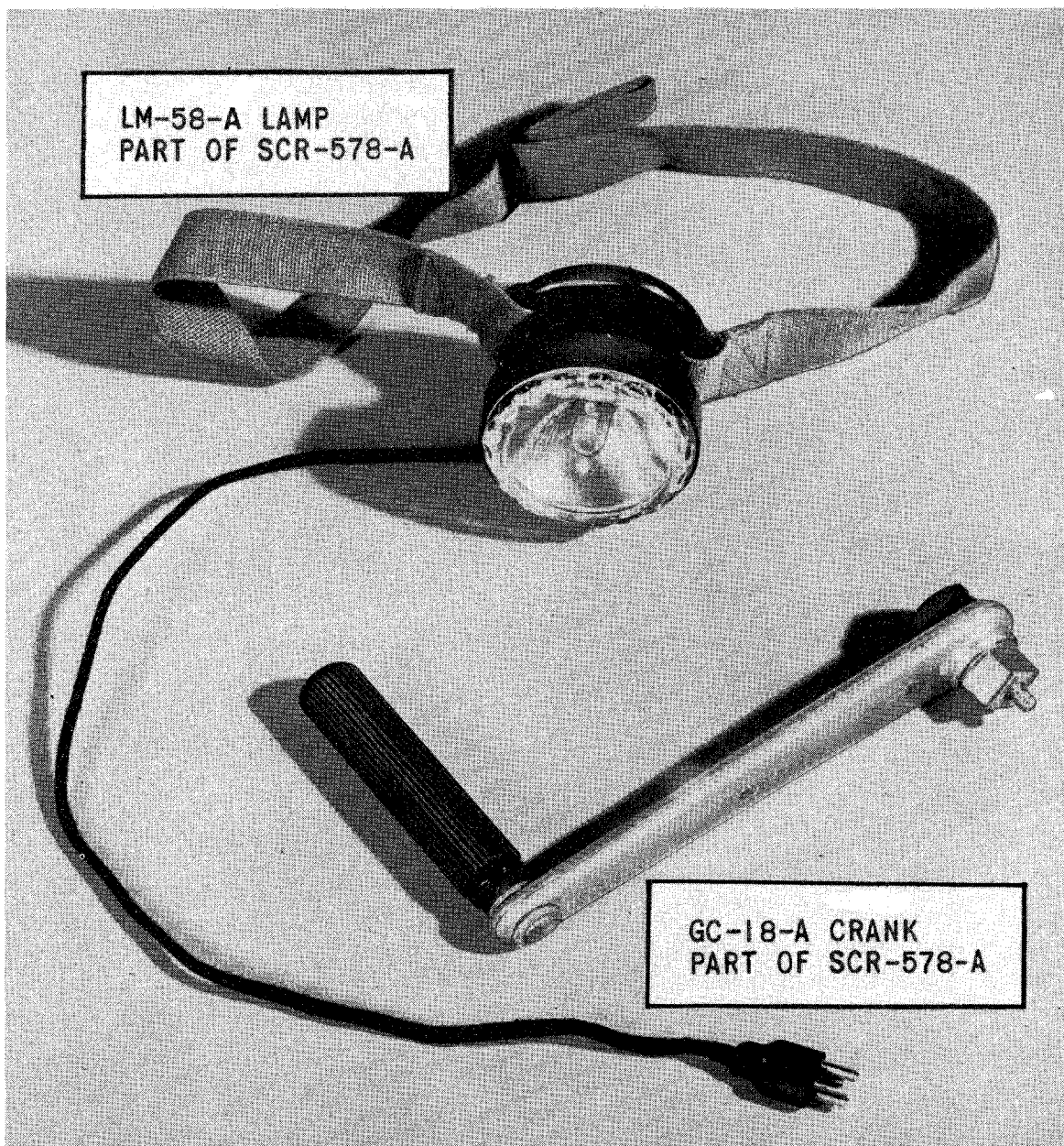

GC-18-A CRANK
PART OF SCR-578-A

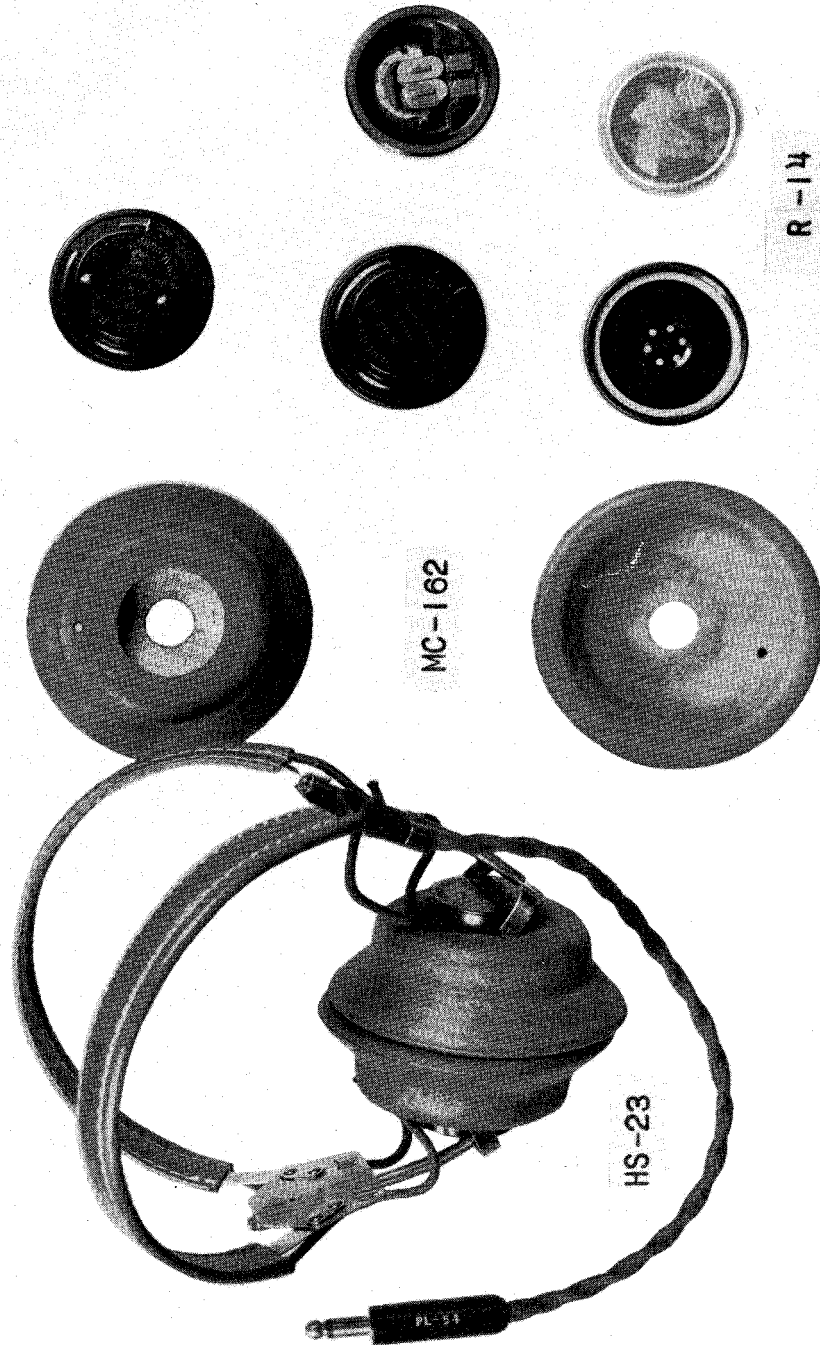

HEADSET HS-23 WITH CUSHION MC-162 AND RECEIVER RC-14

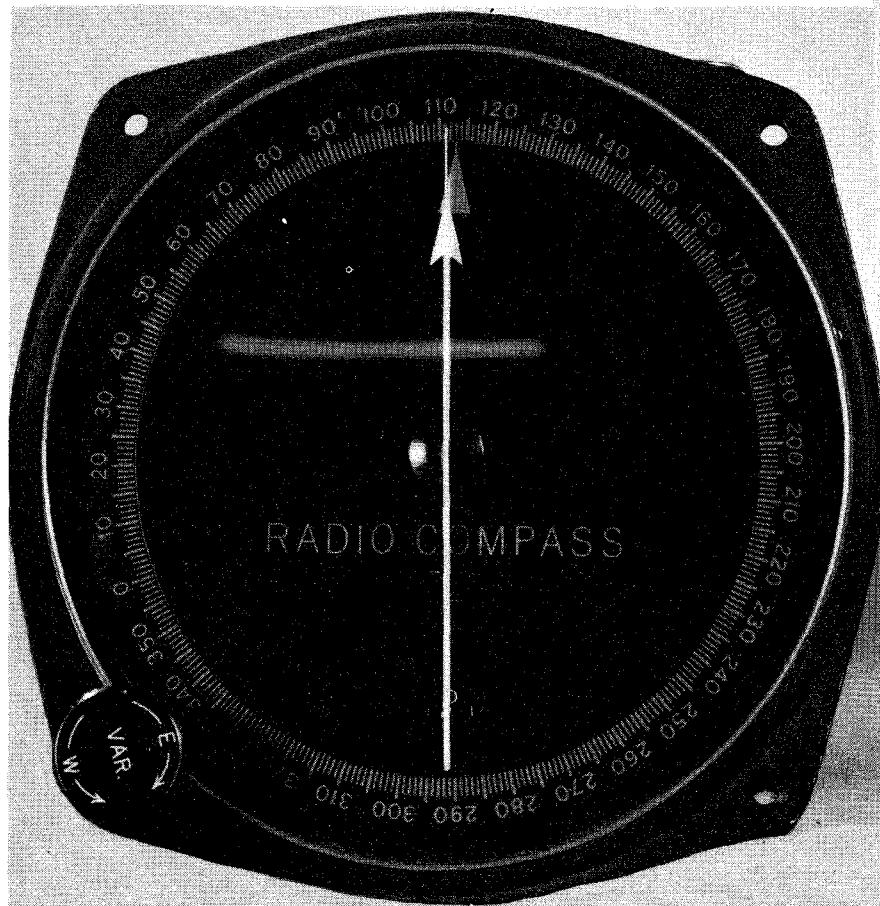

1-75-A BEARING INDICATOR
PART OF SCR-280-A

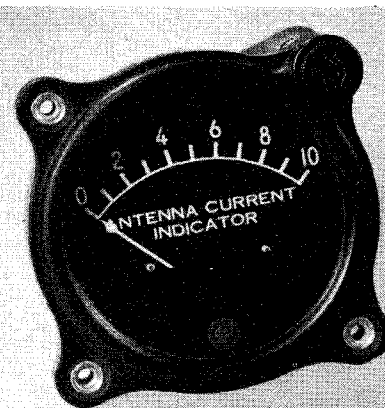

1-71-B AMMETER
PART OF SCR-274-N



1-65-D RADIO COMPASS INDICATOR
PART OF SCR-280-A

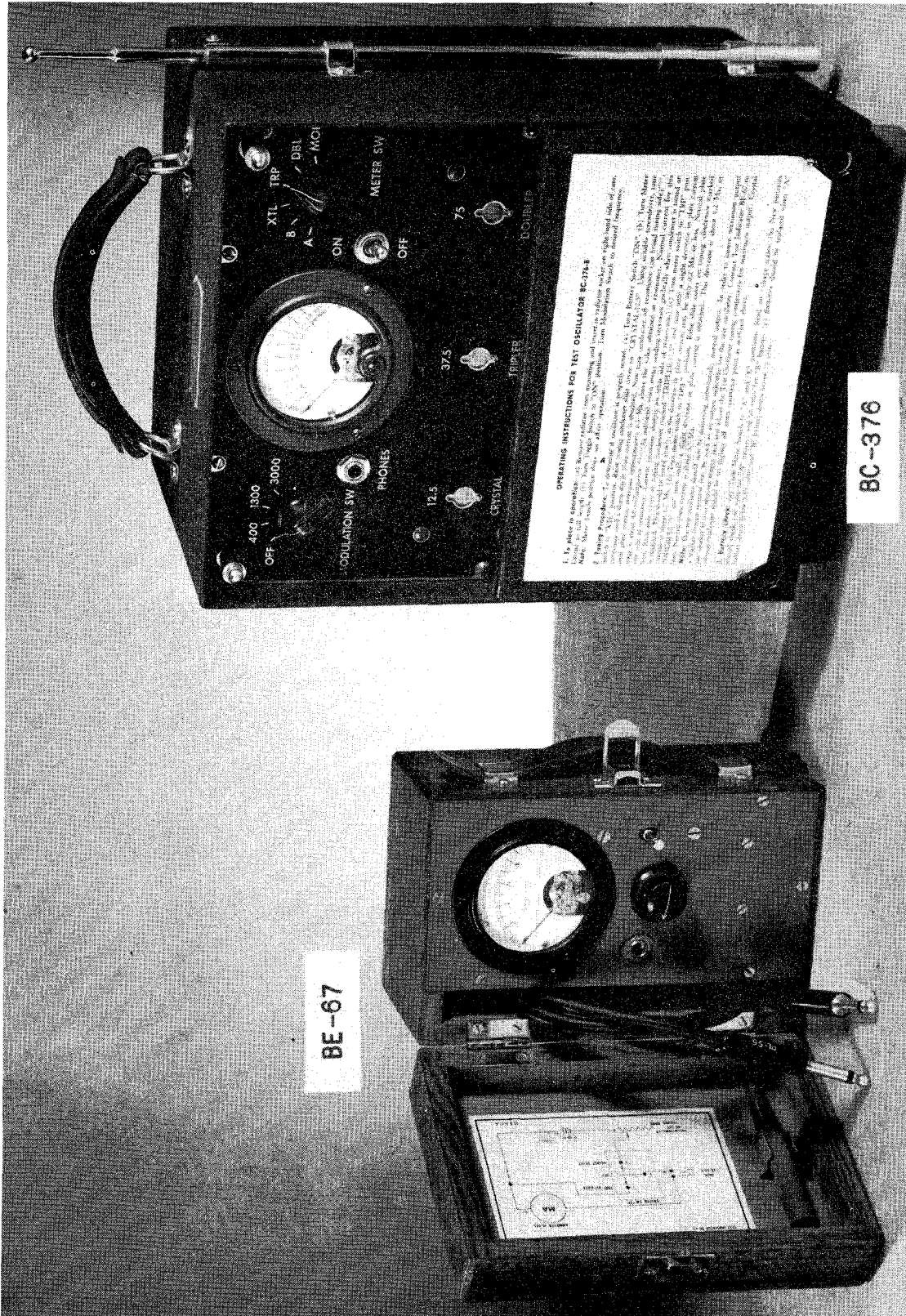

BE-67

BC-376

I-76 MARKER BEACON TEST SET
 Also includes HS-23 Headset not shown on photo

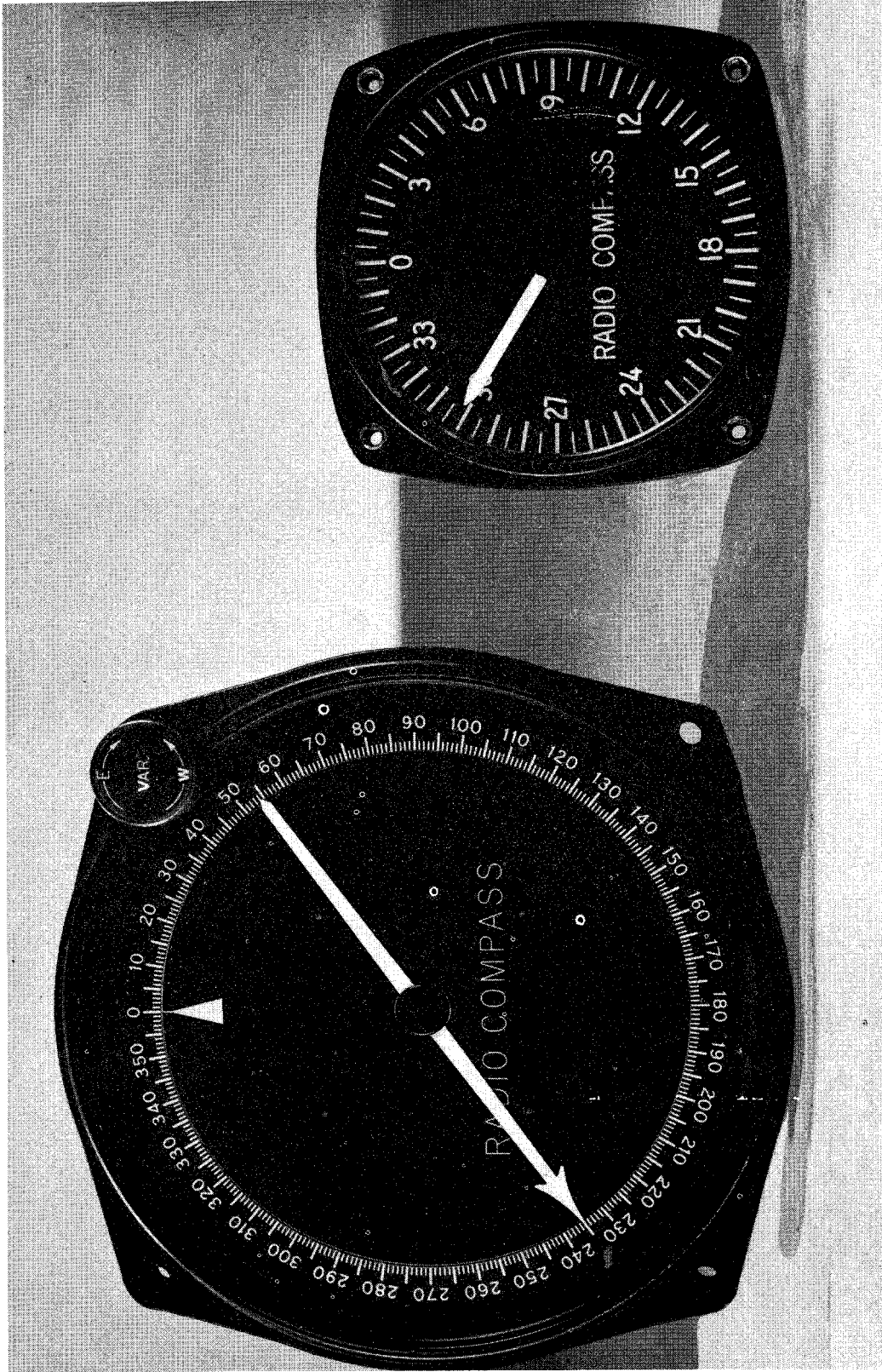

I-81-A PILOT'S BEARING INDICATOR
PART OF SCR-269-G

I-82-A NAVIGATOR'S BEARING INDICATOR
PART OF SCR-269-G



JK-26 JACK
PART OF CORD CD-196 AND CD-307-A

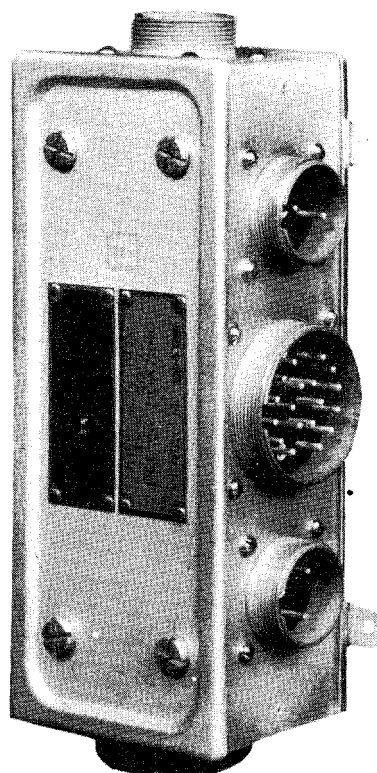

JB-29-A JUNCTION BOX
PART OF SCR-522-A

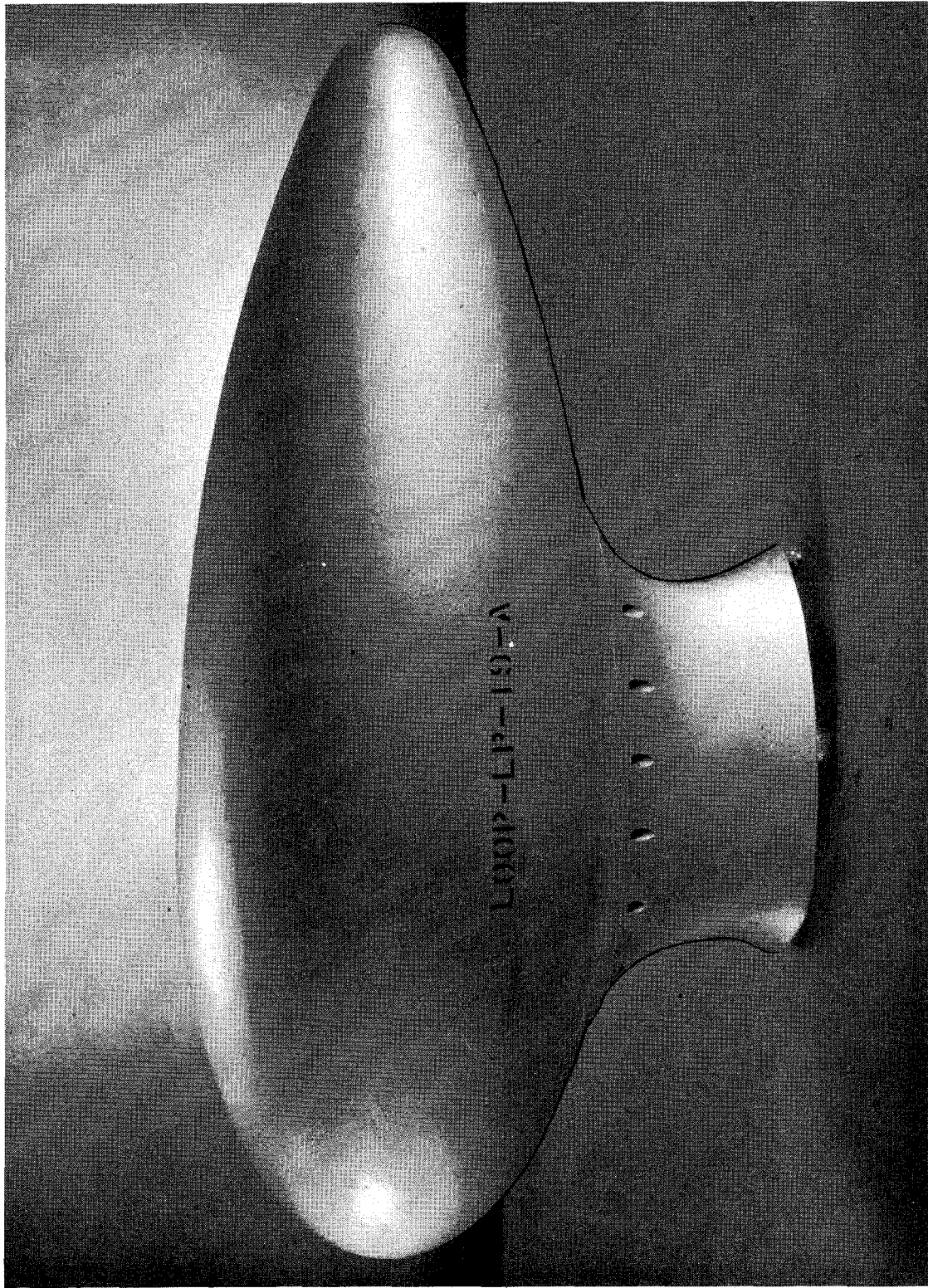

LP-19-A RADIO COMPASS LOOP PART OF RADIO COMPASS SCR-280-A

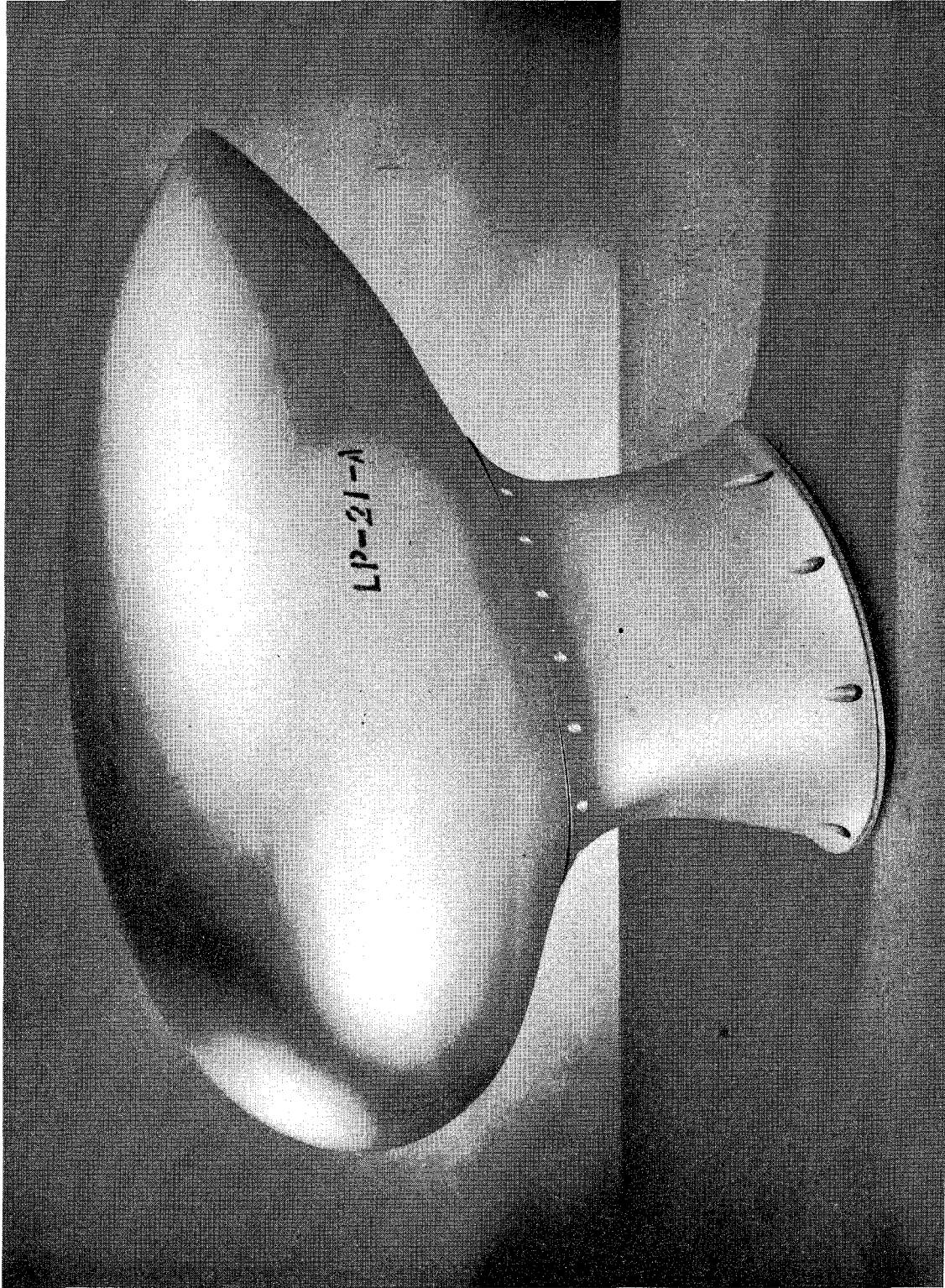

LP-21-A RADIO COMPASS LOOP PART OF RADIO COMPASS SCR-269-G

MC-211-A RIGHT-ANGLED COUPLING
PART OF RADIO SET SCR-274-N

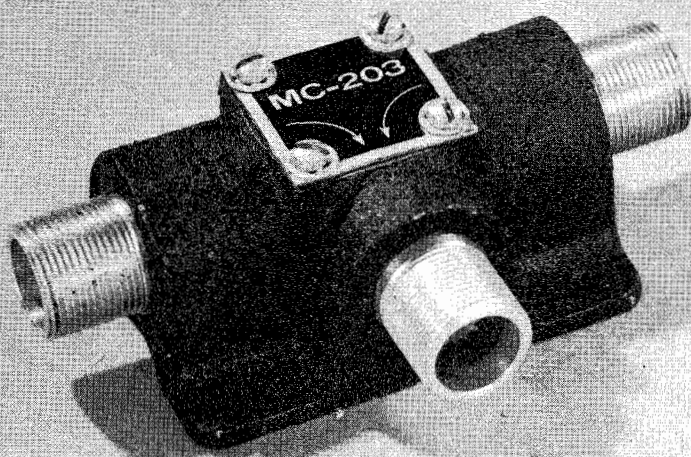
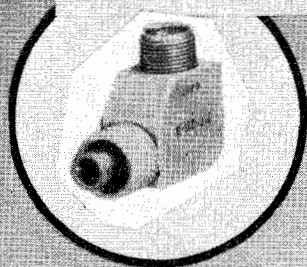

MC-203-A COUPLING
PART OF RADIO SET SCR-269-G

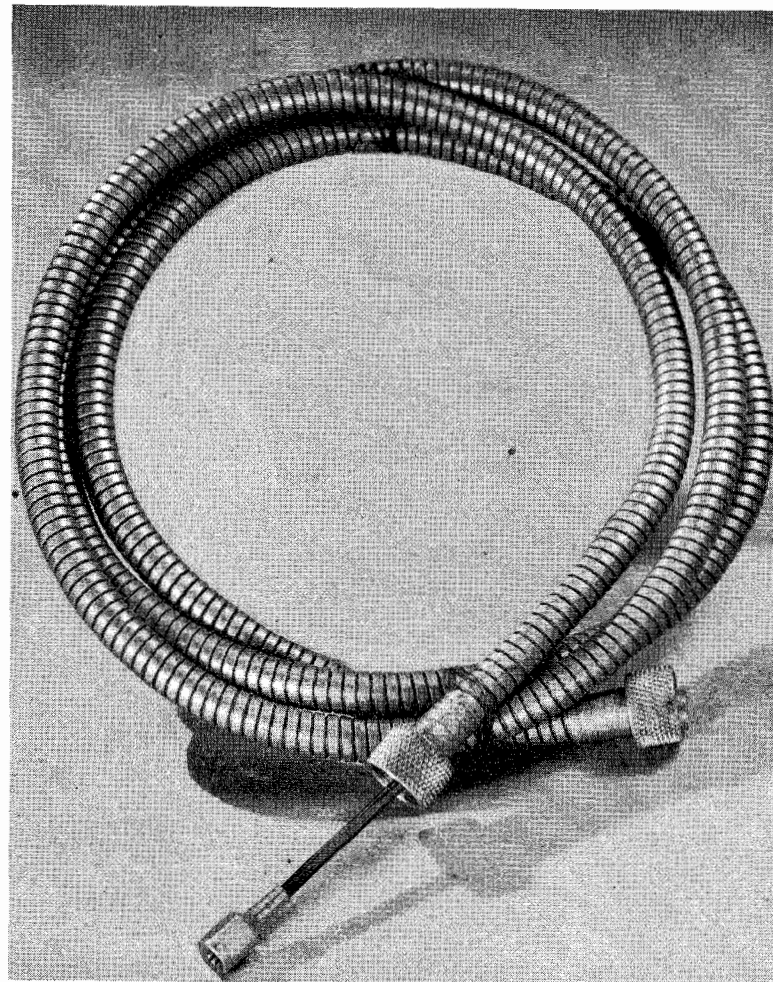

MC-124 RADIO RECEIVER TUNING SHAFT
PART OF RADIO SET SCR-AJ-183.

NOTE: See AAF Technical Order 00-30-69
for information pertaining to
lengths of tuning shaft.



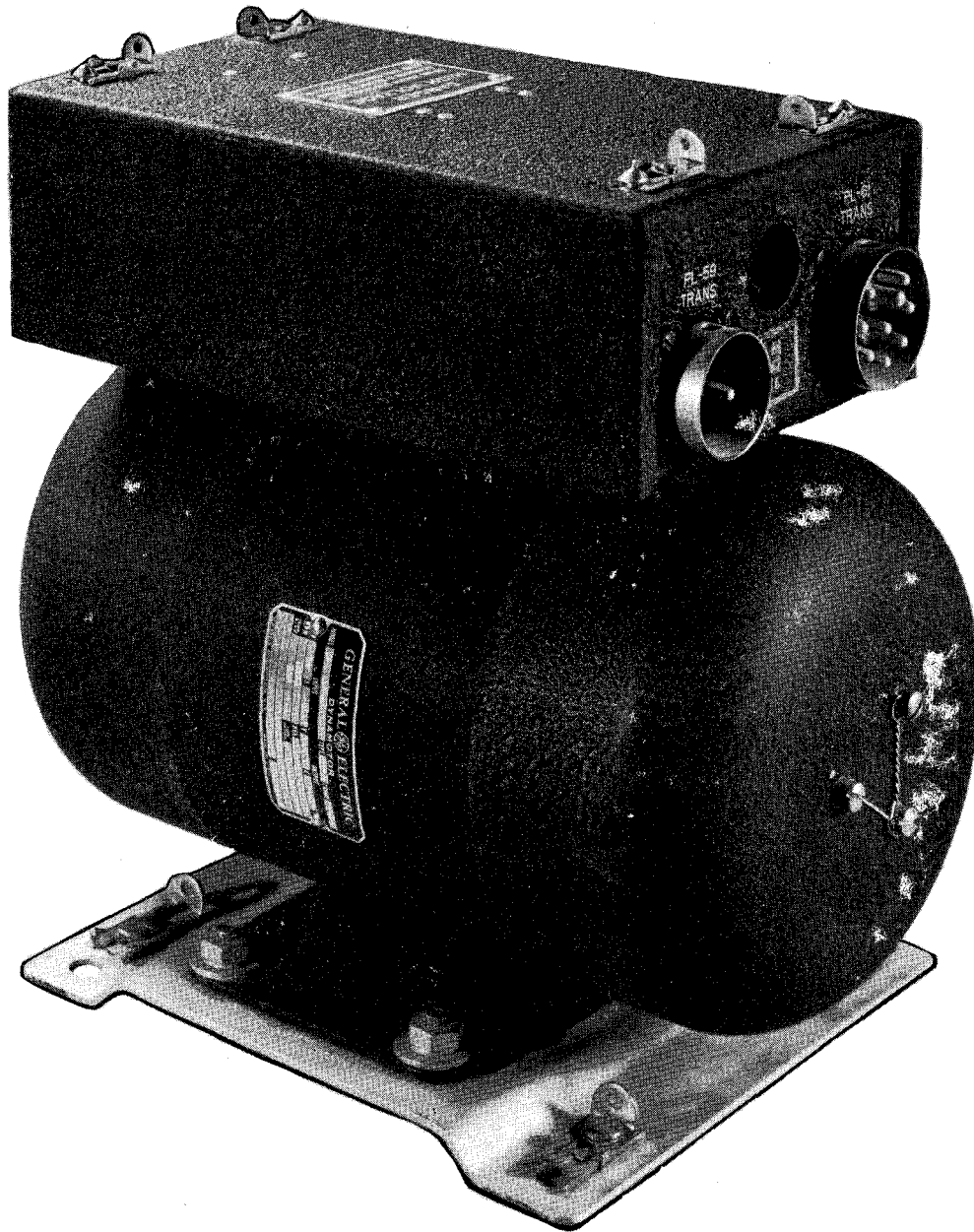

PE-73-C DYNAMOTOR UNIT PART OF RADIO SET SCR-287-A

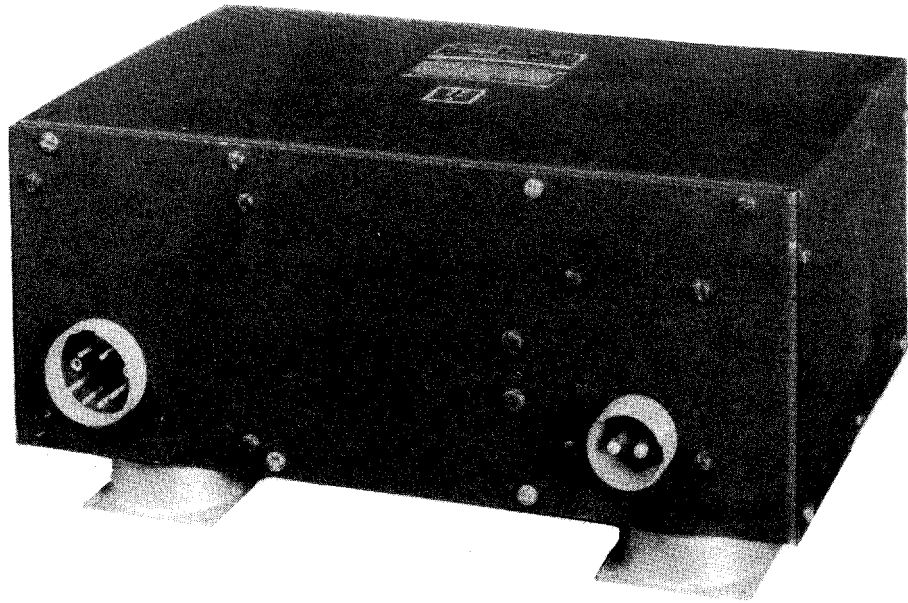

PE-94-A DYNAMOTOR UNIT PART OF RADIO SET SCR-522-A

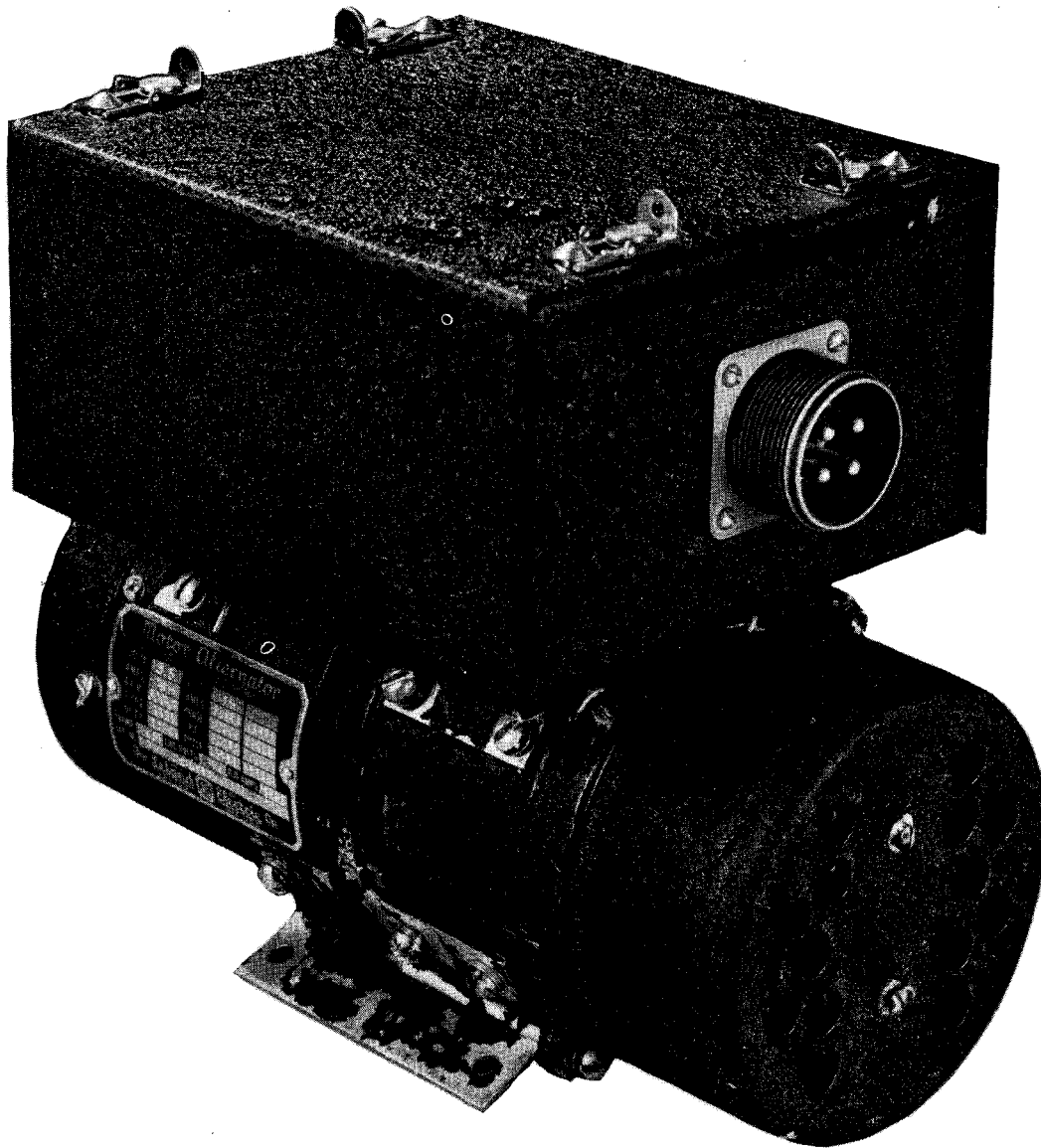

PE-109 ALTERNATOR USED WITH BUT NOT PART OF SCR-269-G COMPASS
Generates 115 Volts AC at 400 Cycles. Used in planes which do not have 400 Cycle Alternators as part of the plane.

PL-68 PLUG

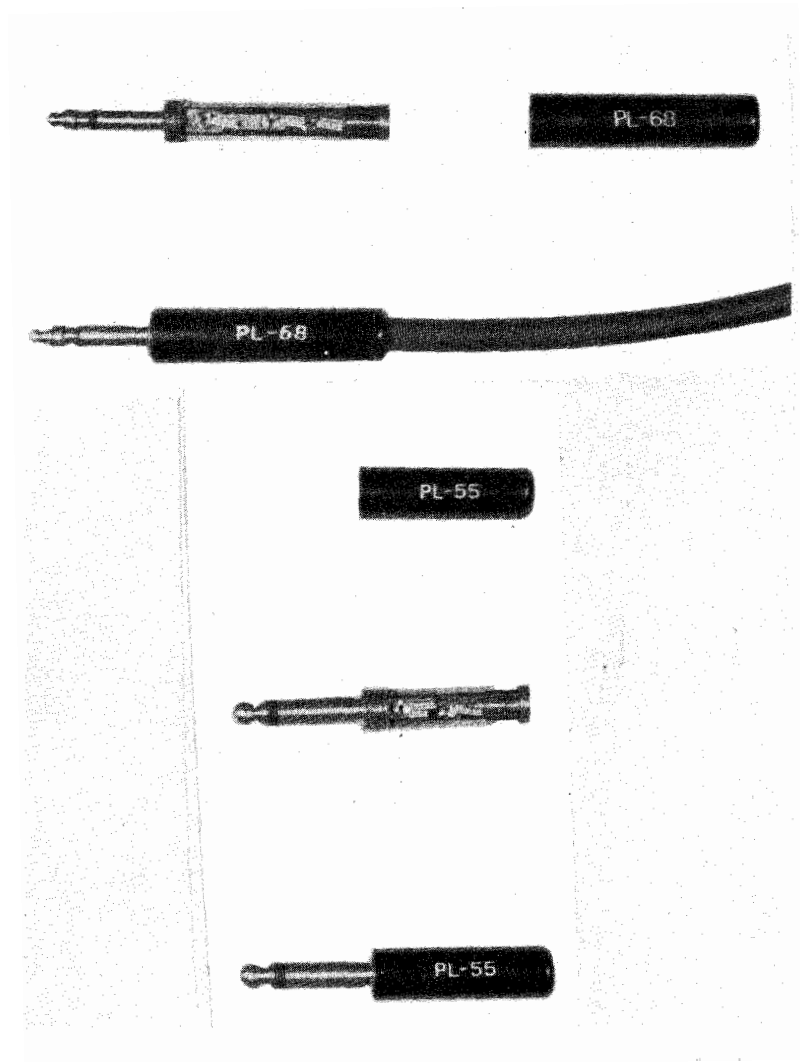

PL-55 PLUG

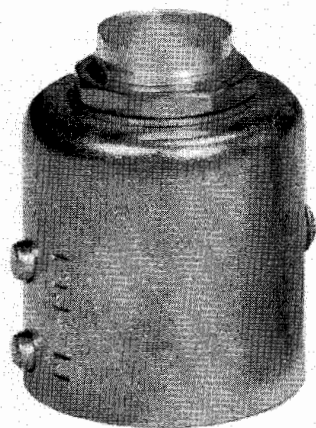

FRONT VIEW

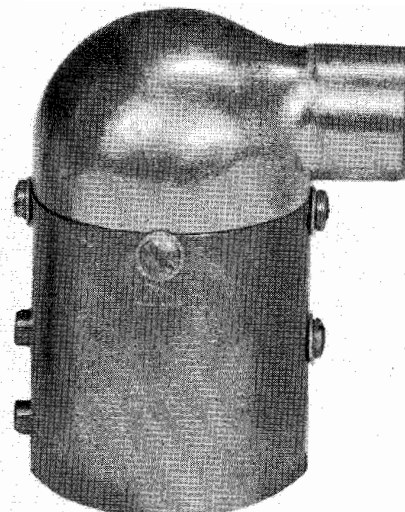

FRONT VIEW

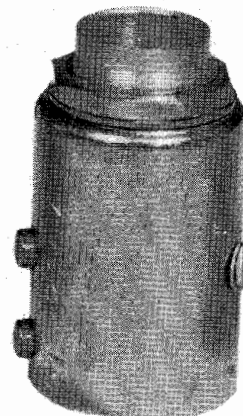

FRONT VIEW

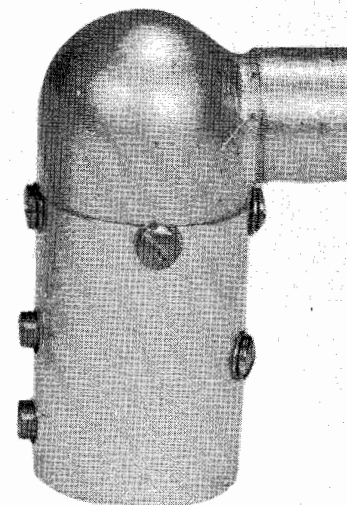

FRONT VIEW

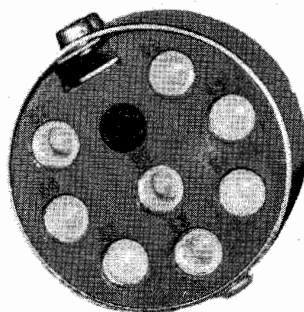

BOTTOM VIEW
PLUG PL-P61
JUNCTION BOX TO RADIO
RECEIVER BC-AR-229

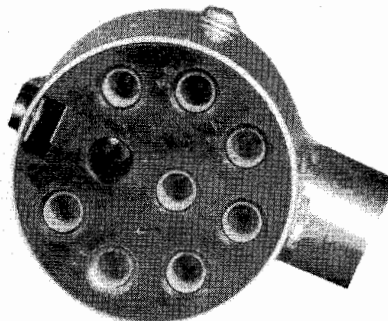

BOTTOM VIEW
PLUG PL-Q81
JUNCTION BOX TO RADIO
RECEIVER BC-AR-229

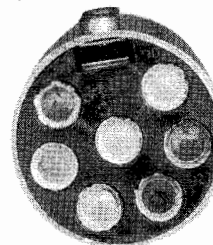

BOTTOM VIEW
PLUG PL-P104
JUNCTION BOX TO RADIO
CONTROL BOX BC-AR-231

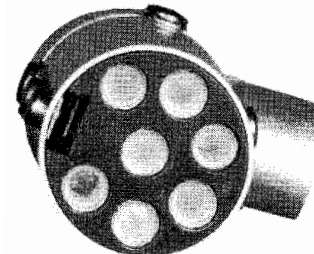

BOTTOM VIEW
PLUG PL-Q104
JUNCTION BOX TO RADIO
CONTROL BOX BC-AR-231

PLUGS FOR RADIO SET SCR-AR-183
(ACTUAL SIZE)

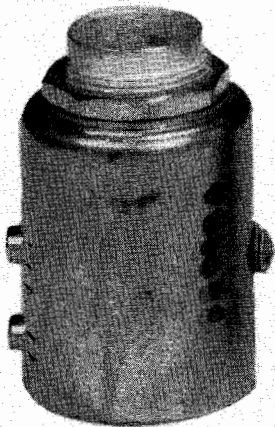

FRONT VIEW

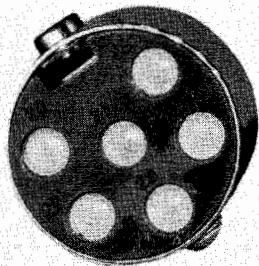

BOTTOM VIEW
PLUG PL-P62
JUNCTION BOX TO
DYNAMOTOR UNIT BD-AR-83

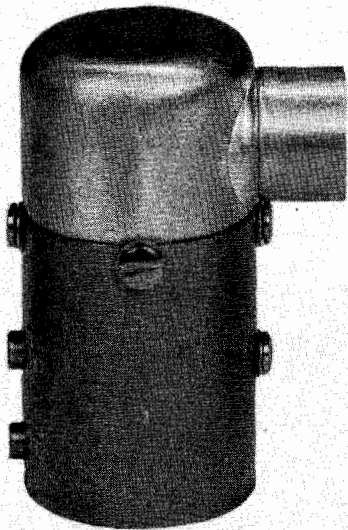

FRONT VIEW

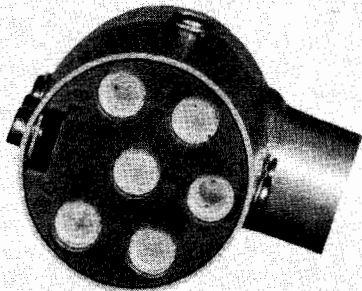

BOTTOM VIEW
PLUG PL-Q62
JUNCTION BOX TO
DYNAMOTOR UNIT BD-AR-83

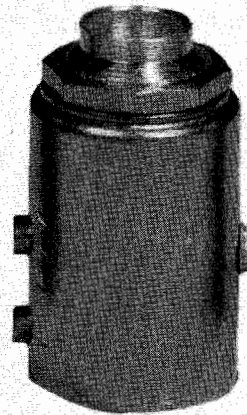

FRONT VIEW

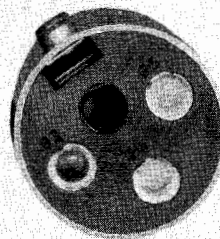

BOTTOM VIEW
PLUG PL-P77
JUNCTION BOX TO ANTENNA
SWITCHING RELAY BC-AR-198

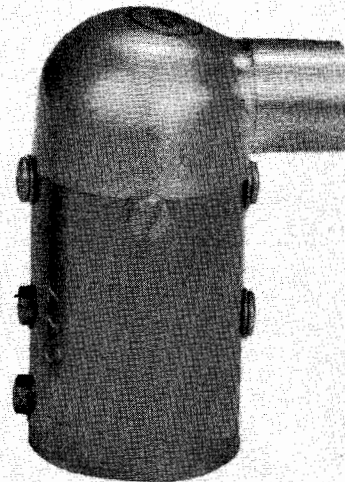

FRONT VIEW

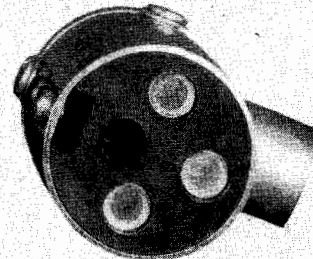

BOTTOM VIEW
PLUG PL-Q77
JUNCTION BOX TO ANTENNA
SWITCHING RELAY BC-AR-198

PLUGS FOR RADIO SET SCR-AR-183
(ACTUAL SIZE)

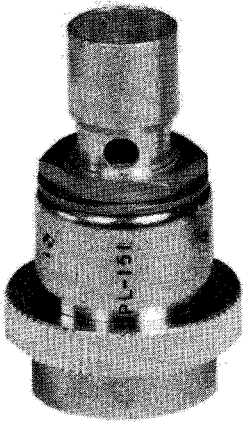

FRONT VIEW

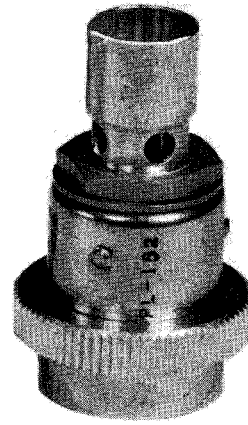

FRONT VIEW

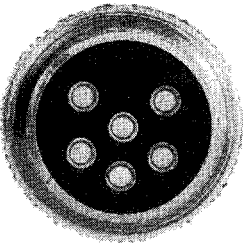

BOTTOM VIEW
PLUG PL-151
RECEIVER RADIO CONTROL BOX
TO RACK FT-220-A

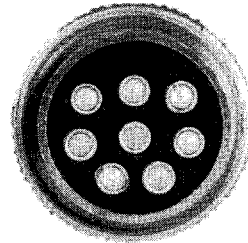

BOTTOM VIEW
PLUG PL-152
MODULATOR UNIT BC-456-A
TO RACK FT-220-A

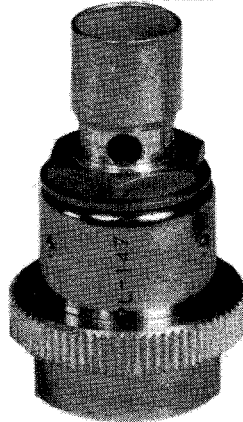

FRONT VIEW

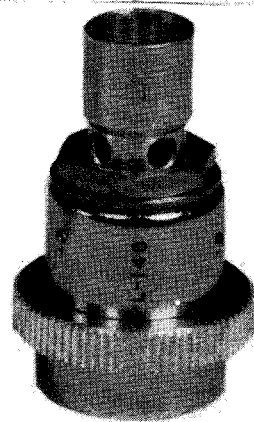

FRONT VIEW

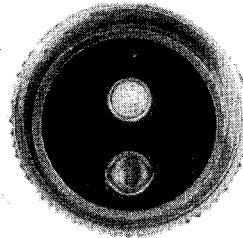

BOTTOM VIEW
PLUG PL-147
PRIMARY POWER SUPPLY
TO RACK FT-220-A

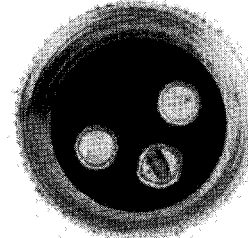

BOTTOM VIEW
PLUG PL-148
MODULATOR UNIT BC-456-A
TO PRIMARY POWER

**PLUGS FOR RADIO SET SCR-274-N
(ACTUAL SIZE)**

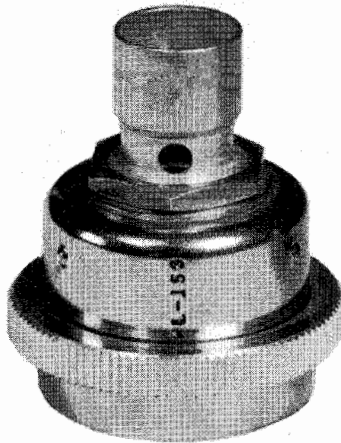

FRONT VIEW

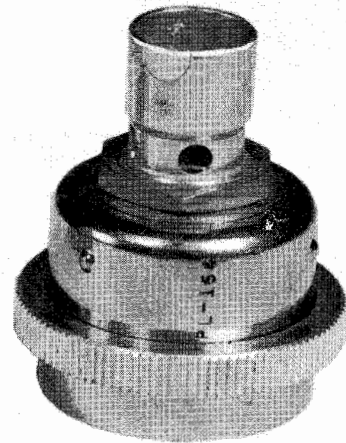

FRONT VIEW

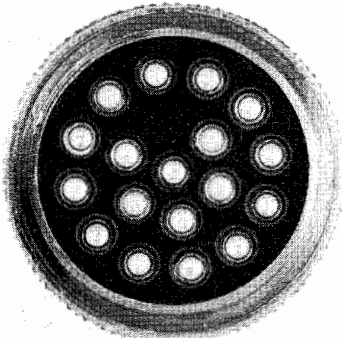

BOTTOM VIEW
PLUG PL-153
MODULATOR UNIT BC-456-A
TO RADIO CONTROL BOX 451-A

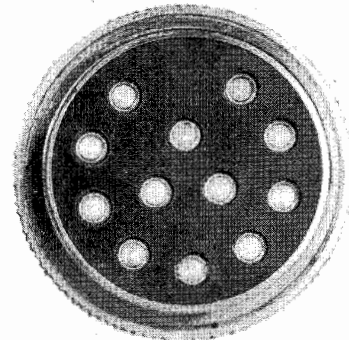

BOTTOM VIEW
PLUG PL-154
MODULATOR UNIT BC-456-A
TO RACK FT-226-A

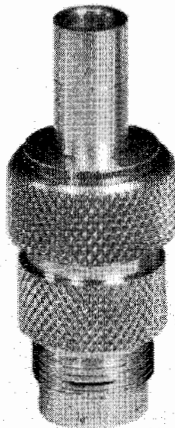

FRONT VIEW

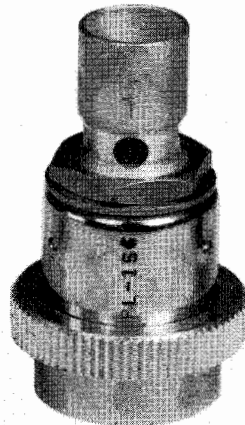

FRONT VIEW

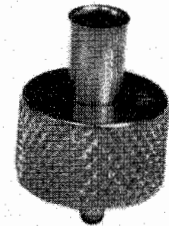

FRONT VIEW

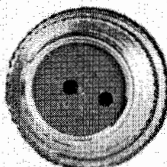

BOTTOM VIEW
PLUG PL-156
RADIO CONTROL BOX BC-451-A
TO AMMETER I-71-B

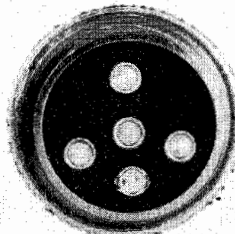

BOTTOM VIEW
PLUG PL-158
RACK FT-226-A TO ANTENNA
RELAY UNIT BC-442-A

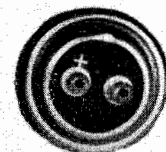

BOTTOM VIEW
PLUG PL-157
RADIO CONTROL BOX BC-451-A
TO AMMETER I-71-B

**PLUGS FOR RADIO SET SCR-274-N
(ACTUAL SIZE)**

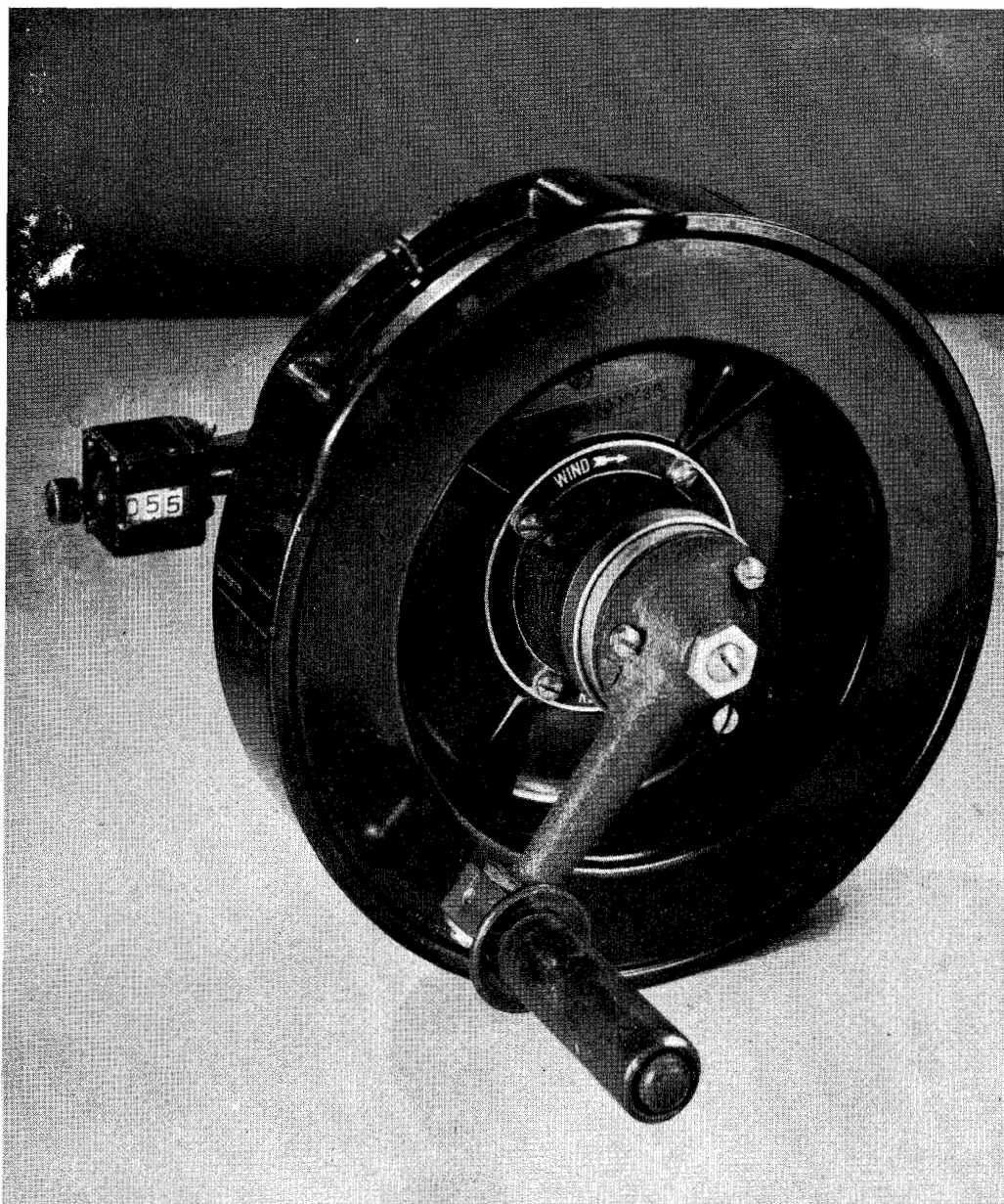

RL-30-B AIRCRAFT ANTENNA REEL
PART OF RADIO SET SCR-187-A OR SCR-287-A

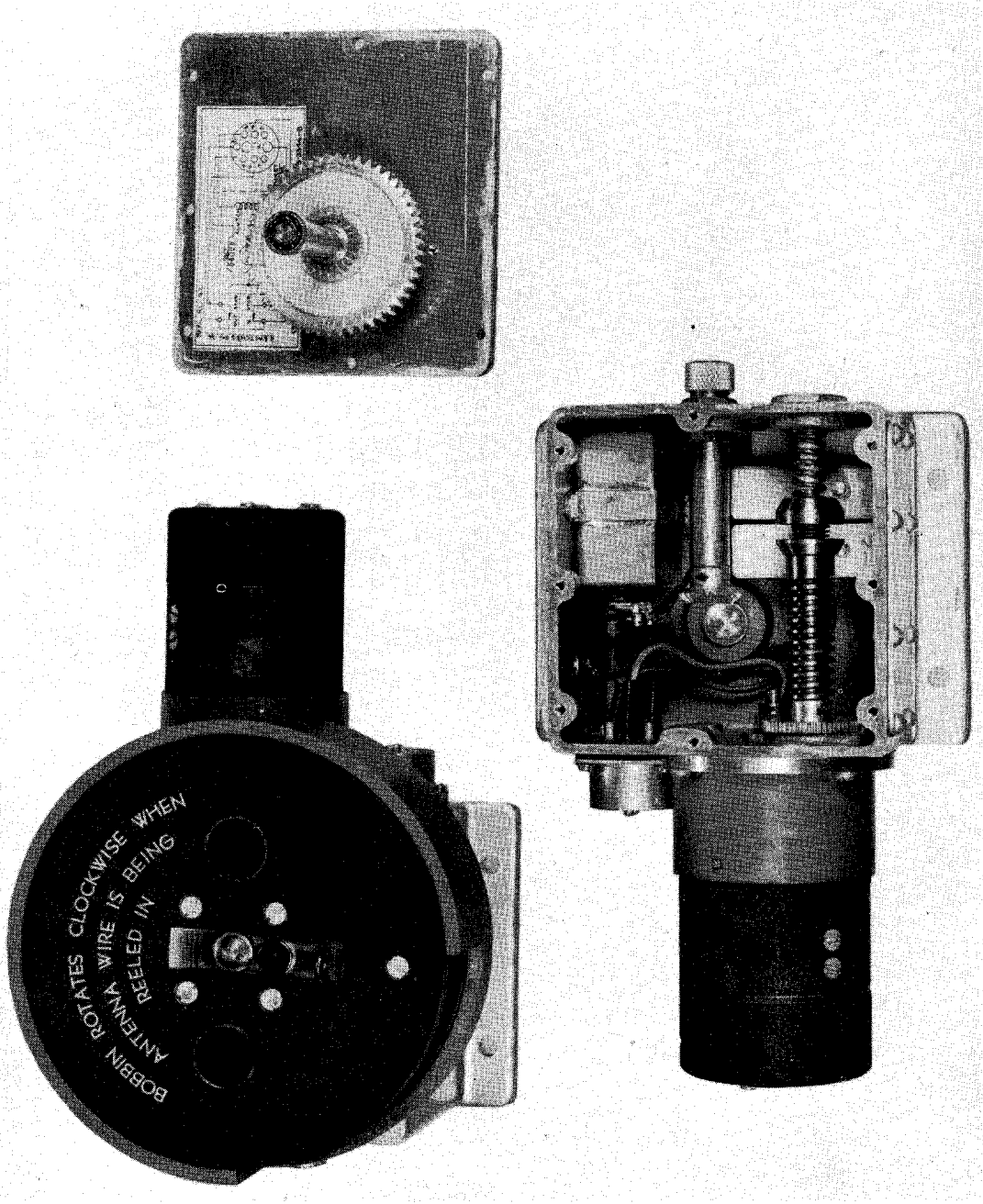

RL-42-A AUTOMATIC AIRCRAFT ANTENNA REEL
PART OF RADIO SET SCR-287-A

T-30 THROAT MICROPHONE
PART OF VARIOUS RADIO SETS
AND INTERPHONE EQUIPMENTS

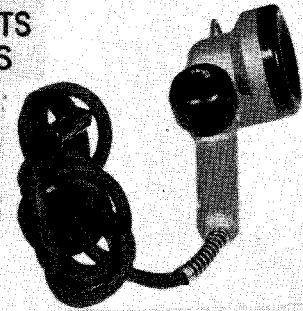
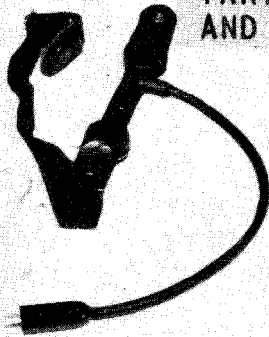

T-17 HAND MICROPHONE
PART OF VARIOUS RADIO SETS

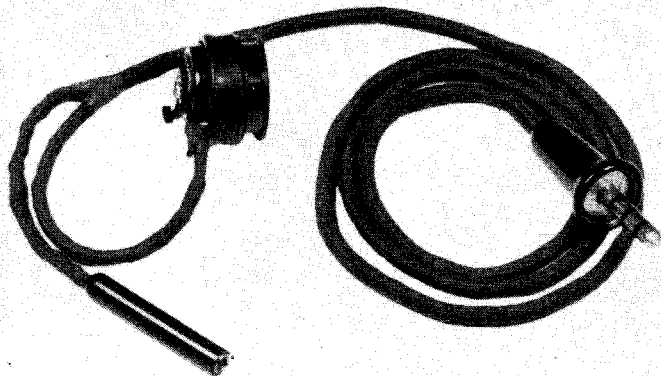

T-34-A OXYGEN MASK MICROPHONE
USED WITH BUT NOT PART OF SCR-522-A

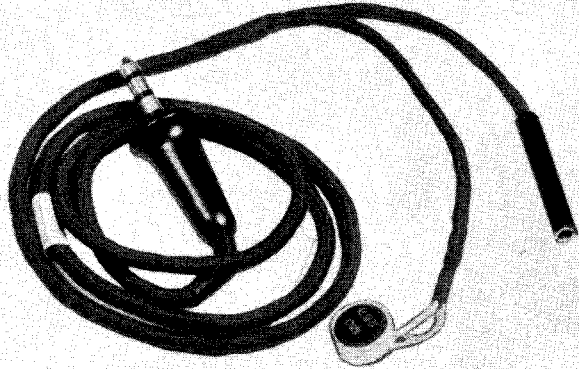

T-44 OXYGEN MASK MICROPHONE
USED WITH RADIO SET SCR-522-A

**WT-7-A AIRPLANE ANTENNA WEIGHT
PART OF RADIO SET SCR-287-A**

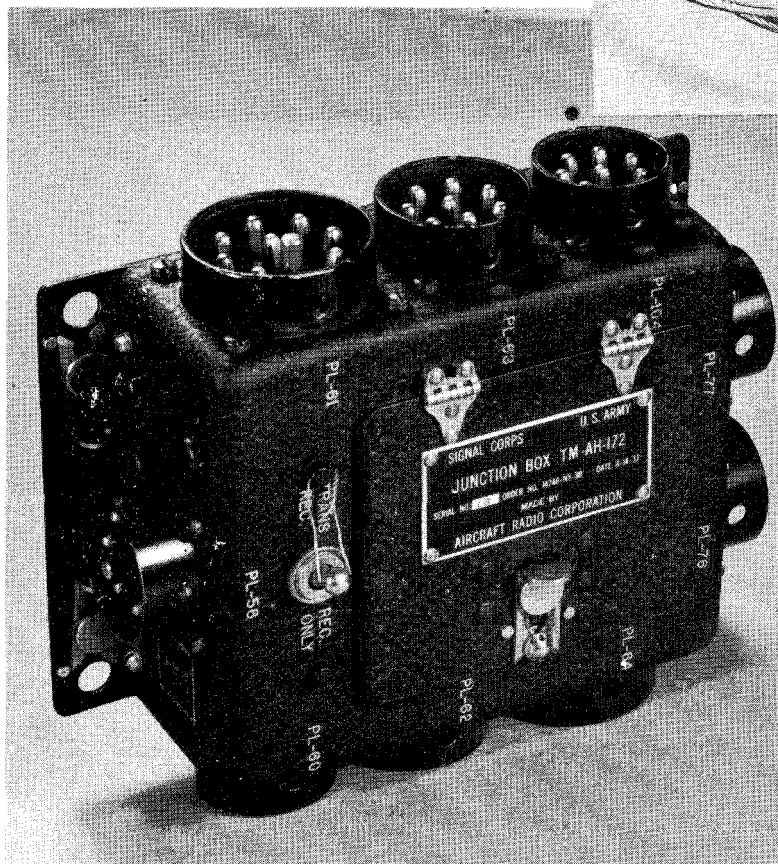
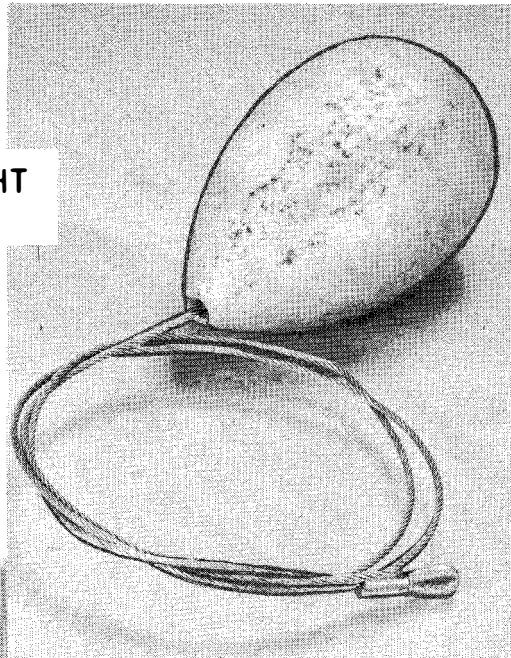

**TM-AH-172 JUNCTION BOX
PART OF RADIO SET SCR-AJ-183**

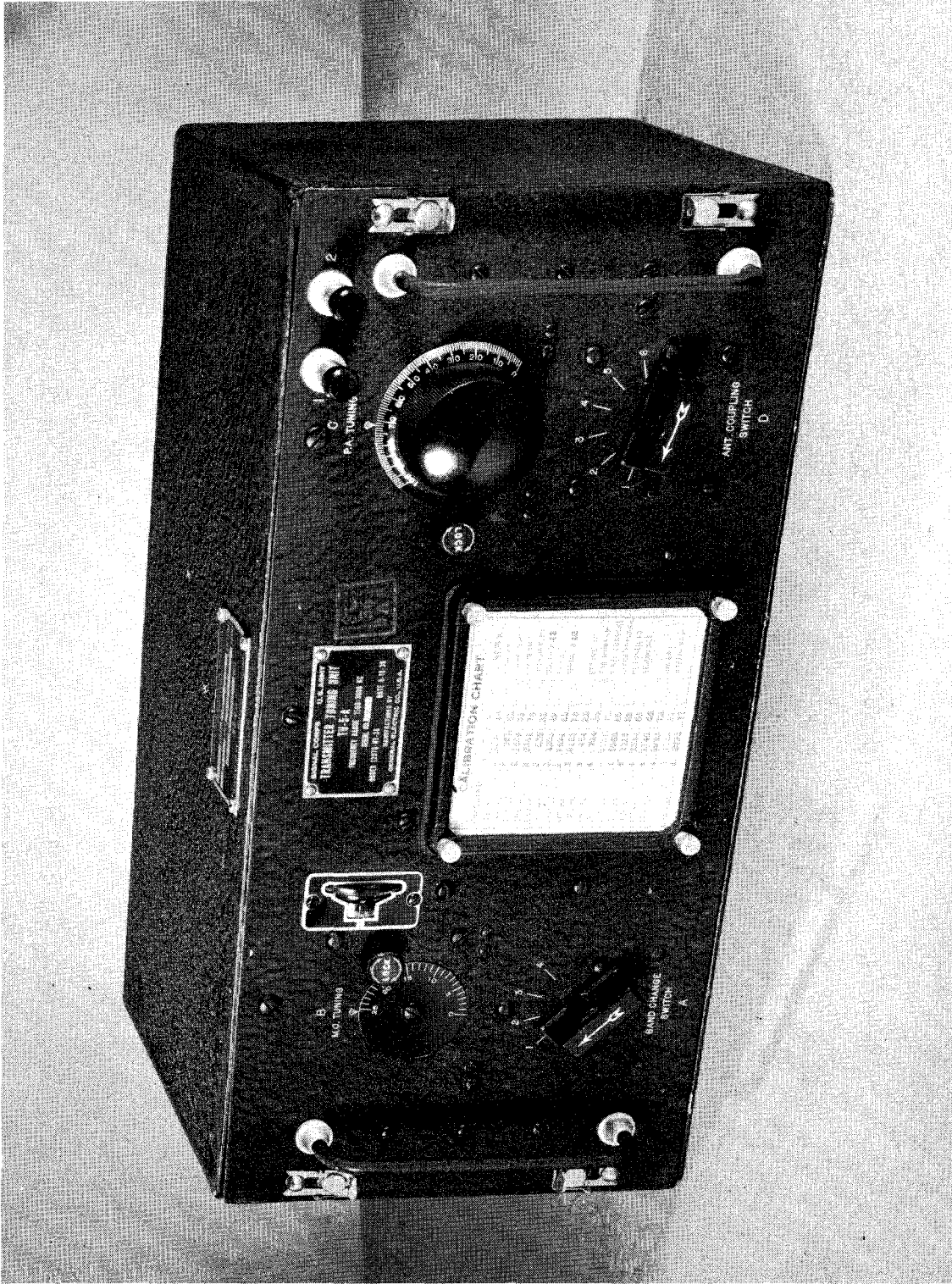

TU-5-A TRANSMITTER TUNING UNIT
 PART OF RADIO SETS SCR-187-A AND SCR-287-A

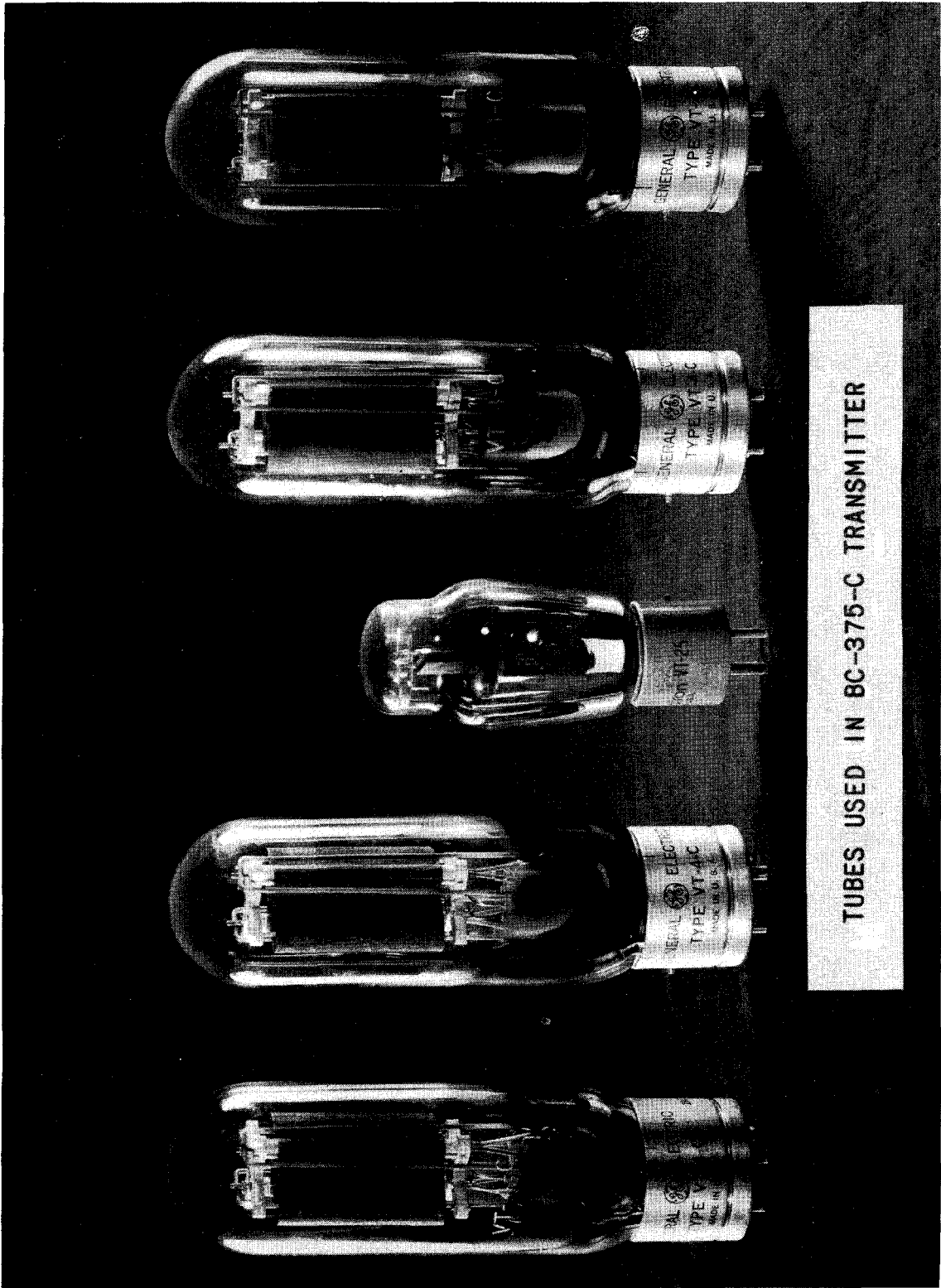

WC-537 CABLE PART OF MARKER BEACON RECEIVING EQUIPMENT
RC-39-A AND RC-43-A

WC-538 CABLE PART OF MARKER
BEACON RECEIVING EQUIPMENT
RC-39-A AND RC-43-A

TM-187 ANTENNA LEAD-IN TERMINAL
PART OF MARKER BEACON RECEIVING
EQUIPMENT RC-39-A AND RC-43-A

Flow of Domestic Requisitions for Airborne Equipment

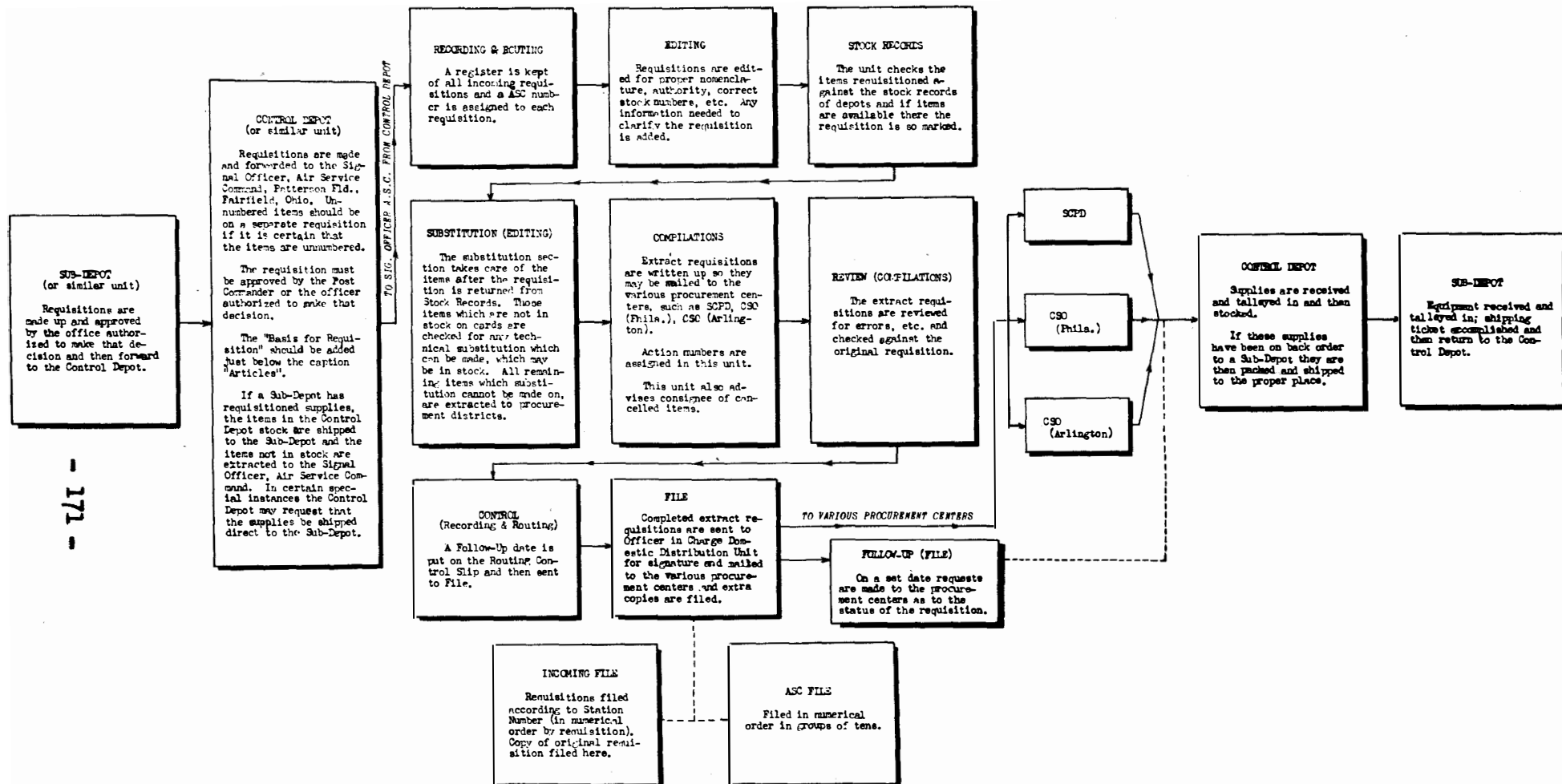

SUPPLY-ACCOUNTABILITY-RESPONSIBILITY

It is suggested that every supply officer get a copy of TM-452 (Technical Manual), subject, Signal Supply, ASC, Memo 135-1, AAF Reg. 65-10, dated December 17, 1942, and W.D. Cir. 52.

Be sure that all property shipped to you is carefully checked in. See that you have a responsible party OK a shipping ticket before you sign it.

On property being shipped out see that it is double checked.

Spot inventory your stock often.

See to it that the person in charge of your stock records and bin cards are extremely accurate in this work.

Try to personally approve all property that goes out of your warehouse on Memorandum Receipt.

Be sure that only authorized persons sign Store Charges.

Follow these rules, use good common sense, and you will have nothing to worry about.

Accountability and/or responsibility devolve upon any person to whom public property is intrusted and who is required to maintain a property account thereof.

An officer who carries property on a stock record account and has such property in his possession, either in use or in storage, has "accountability" but not "responsibility" for property which he has issued to others on memorandum receipt. The accountable officer continues to carry on his stock record account the property issued to others on memorandum receipt.

An officer who has given a memorandum receipt for property will not take such property up on a stock record account, and is not "accountable" therefore, but becomes responsible for its care and preservation and will not be relieved of such responsibility until he has returned the property to the accountable officer or secured memorandum receipts from a successor, or until he has otherwise been relieved by the operation of regulations or orders.

The property of the Military Establishment is divided into three classes, and includes real property, permanent property, and supplies.

Real property includes lands, grounds, buildings, docks, piers, offices, storage spaces, etc., and when in current service will be carried on the permanent historical records and will not be taken up on the property accounting records described herein except when held awaiting sale, salvage, or other disposition.

Permanent property includes permanently installed machinery, appliances, and apparatus, and will be taken up on the permanent historical records and dropped from the property accounting records.

Supplies include all raw materials, commodities, manufactured articles, means of transport, unit assemblages, and units of equipment, procured, stored, or issued to the Army, and, unless permanently installed, are accounted for on property accounting records. Supplies are classified as expendable and nonexpendable:

a. Property of the following classes is expendable:

- (1) Articles which are "consumed" in the maintenance and upkeep of

the public services as distinguished from "worn," such as oil, paint, forage, cleaning and preserving material, etc.

- (2) Articles such as spare and repair parts, and components which are used to repair or complete other articles and thereby lose their identity.
- (3) Articles which are attached to and become a permanent part of a building.
- (4) Materials used by governmental activities in manufacturing, and for testing and experimenting purposes.
- (5) Ammunition when used within the prescribed allowances and for prescribed purposes.

b. Accountability for nonexpendable property is retained until the property is transferred, worn out or otherwise disposed of, and the manner in which accountability is terminated.

All property is further classified alphabetically to indicate its condition of serviceability. Class "A" indicates new property; class "B" reclaimed property, or property used but still serviceable; class "C" is unserviceable property the condition of which justifies reclamation; and class "D" is unserviceable property not fit for reclamation, including waste products, and property which has been declared obsolete by the War Department.

Accountability for public property will not be transferred to a warrant officer, enlisted man, or civilian employee when there is a commissioned officer present.

The sale, gift, loan, exchange, or other disposition of any Government property not specifically authorized by law, regulations, or orders is illegal.

Salvage officers, and officers in charge of reclamation, or similar agencies established under property authority for the purpose of reclaiming such component parts as may be worth reclaiming of articles damaged or otherwise rendered unserviceable beyond the stage of economical repair, will not be required to maintain a stock record account, as contemplated herein, of the property turned in for salvage or reclamation, but the Chief Signal Officer will require such records to be kept of the property turned in for salvage or reclamation as will permit the final disposition of all property, including both the reclaimed components and the reclaimable residue, to be traced.

Officers will be responsible for the property issued to them on memorandum receipt for their own use or for the use of those under their control.

When an officer or other individual is detached from duty at a post, camp, or station, or is separated from the service by resignation or discharge and holds public property on memorandum receipt, he will turn in such property and effect a settlement before leaving. It will be the duty of the commanding officer to see that the prescribed settlement is effected before the departure of the officer or other individual concerned. The property officer will take

possession of such property, carefully check same, and issue a credit slip in duplicate, on which will be listed the articles taken in, the original of which will be sent to the person concerned and the duplicate retained. Should damage, not the result of wear and tear in the service, or a shortage be found to exist, the property officer will advise the officer concerned with a view of securing an adjustment before taking steps to effect collection of the value of the articles short or damaged.

Officers will be designated by the commanding officer of posts, camps, or stations who will sign memorandum receipts for, and be responsible for property issued for the general current use of the post, camp, or station, and not issued to organizations or individuals.

In accomplishing the inventory of property and supplies the following procedure may normally be followed:

a. Original packages and packages that have been assembled, verified, marked, and sealed locally need not be opened for inventory if there is no evidence indicating that they have been tampered with. As large a proportion as practicable of property and supplies to be inventoried should be kept in such packages, and the contents as listed thereon may be accepted for inventory purposes. Other expedients absolutely insuring that any tampering will be made evident are authorized.

b. In an appropriate case the balance on hand of an article may be determined for inventory purposes by comparing the total weight of all articles on hand with the ascertained weight of one or of a definite number of such articles; likewise, the total number or weight may be determined by comparing the total cubic feet dimensions of all such articles on hand with the ascertained number or weight of such articles in a cubic foot, or in a definite number of cubic feet. In case the balance as determined by weight differs no more than 2 percent from the balance shown on the stock record cards, the latter will be considered the true balance on hand.

Whenever it is necessary or desirable to change the nomenclature under which an article is carried on a property account, or to account by individual items for property which has formerly been accounted for as a complete unit or set of parts, or vice versa, an over, short, and damaged report will be prepared in duplicate as debit and credit vouchers, listing thereon the former nomenclature and quantity as the "quantity short" and the new nomenclature and quantity as the "quantity over." The items listed as "quantity short" will be taken up in lieu thereof. Where the number of items involved required it, lists may be prepared and attached to the over, short, and damaged report.

When public property is lost, destroyed, damaged, or rendered unserviceable, except for fair wear and tear in the military service, it is necessary to investigate the circumstances and determine whether the officers or other persons responsible for the property were at fault or negligent in their duties. An investigation of this nature is conducted by an officer specially appointed for the purpose. The report which he renders is known as a "Report of Survey."

Officers and other persons responsible for public property will be charged for any loss or destruction of, or damage to, property for which they are responsible, and the money value thereof will be deducted from their pay, unless they are relieved from responsibility for the loss, destruction or damage by an approved report of survey, or in other manner in accordance with regulations.

Unserviceable and obsolete property is, with reference to its disposition, divided into classes as follows:

a. Class I--Property worn out or otherwise rendered unserviceable by fair wear and tear in the service, and property declared obsolete by the Chief Signal Officer when in his opinion no responsibility attaches to any individual for the public service.

b. Class II--Property rendered unserviceable from causes other than fair wear and tear in the service, and property declared obsolete by the Chief Signal Officer when in his opinion responsibility attaches to an individual, or individuals, for the unsuitableness of the property for the public service.

Wrecked aeronautical equipment. - Aeronautical equipment rendered un-serviceable through wrecks resulting from flights ordered or authorized by proper authority will be considered as property of class I, except when it is determined by an approved survey that the wreck was due to the fault or neglect of some person or persons.

Whenever loss or destruction of, or damage to, public property occurs, requiring the action of a surveying officer, a report of survey will be requested by the responsible officer as soon as practicable and in every case within 30 days after discovery of the loss, destruction, or damage, unless exceptional circumstances, which will be explained by the officer's certificate prevent such action within the prescribed period.

The money total on each sheet of a report of survey in the column headed "Value" will be initialed by the responsible officer. No money total will be initialed.

Erasures, interlineations, and other alterations in the written matter of a report of survey must be initialed by the officer making them.

Whenever the quantity of property delivered by a carrier does not agree with the quantity listed on the corresponding shipping ticket or bill of lading, or whenever the property is received in a damaged condition, a notation of such shortage or damage will be made on the bill of lading given to the

carrier and W.D., Q.M.C. Form No. 445 (Over, Short, and Damaged Report) will be prepared by the receiving officer.

Great care will be taken to prevent property once condemned and ordered dropped from property accounts from being again presented for inspection.

The responsible officer will certify on the inventory and inspection report that the property has not been previously condemned.

Electrical measuring equipment, such as voltmeters, ammeters, voltameters, and similar instruments will, when unserviceable and requiring repairs other than simple things as soldering loose connections, replacing nuts, screws, and any external hardware, be shipped to a signal corps depot for repair, except that authorization may be obtained for local repair, when competent personnel and adequate equipment and facilities are available.

Whenever a quartz crystal fails to operate satisfactorily or becomes defective, it should be shipped with holder to the Signal Officer A.D.C.A.C., together with a certificate setting forth the circumstances under which the crystal became defective. If, however, upon inspection it develops that the crystal shows mechanical defects or is broken or punctured, the unserviceable crystal should be placed on a survey or on an inventory and inspection report, as the circumstances warrant. If the crystal is disposed of in ac-

cordance with regulations, the holders should be removed and forwarded to the Signal Officer A.D.C.A.C.

All vacuum tubes; mercury arc, Cooper-Hewitt, Rectigon, Tungar bulbs and electric light bulbs, except as provided in list below, which have become unserviceable through normal use (fair wear and tear), or through other causes, will be placed on inventory and inspection reports of survey, as circumstances warrant.

Vacuum tubes having a rating of over 100 watts, which fail to render 1,000 hours of service, will be reported to the Chief Signal Officer for disposition. Report of failure will be made through the proper channels and the following tube data furnished:

- a. Station at which failure occurred.
- b. Type of tube: Signal Corps . . . manufacturer's.
- c. Contractor and order on which tube was purchased.
- d. Serial number of tube.
- e. Date tube was accepted by inspector.
- f. Requisition number and depot from which tube was shipped.
- g. Date tube was received at using station.
- h. Date tube was placed in service.
- i. Date tube became inoperative.
- j. Total hours in operation prior to failure.
- k. Probable cause of failure.
- l. Remarks and recommendations.

A transfer of public property involves a change of possession and accountability. In ordinary cases of transfer the transferring officer will furnish the receiving officer with shipping tickets in duplicate, accurately enumerating the property, and the latter will return one signed copy. In cases in which complete transfer of property occurs, instead of exchanging shipping tickets as above provided, both the transferring officer and his successor will satisfy themselves by count and examination, under their personal supervision, that all balances on the stock record cards are actually on hand and in the condition shown on the cards. When excesses are found upon taking an inventory incident to transfer of property, they will at once be taken up on the stock account, and when loss, damage, or deficiency is discovered a surveying officer will at once investigate and ascertain the cause thereof, which he will report, with his conclusions as to the responsibility for the same.

When an officer is relieved from duty as property officer, a physical inventory will be made of such number of items of property as may be necessary to satisfy the officers concerned of the correctness of the balances shown on the stock record accounts.

The officer being relieved of accountability will prepare, in triplicate, a list of balances as shown by the stock record accounts. The officer being relieved of accountability and the officer assuming accountability will sign certificates as follows on all copies of the statement of balances:

_____, 19_____
(Place) (Date)

I certify that the balances shown on the stock record account of the _____ as of the above date, last voucher No. _____ (Destination of the account) dated _____, 19_____, are true and correct to the best of my knowledge and belief, and that the property has this date been turned over to _____ (Name of receiving officer) pursuant to _____ (Order directing transfer)

(Officer turning over property)

I certify that I have received from _____ predecessor, all property pertaining to the above designated stock record account for which my said predecessor is accountable, as shown by the last audit of the account plus all proper charges against and less all authorized credits to my predecessor's account to the time of transfer, last voucher No. _____, dated _____, 19_____, and that I have this date assumed accountability for the property pertaining to this account.

(Officer receiving property)

APPROVED:

(Commanding).

One copy of the statement of balances will be retained by the officer who is relieved of the accountability; one copy will be filed with the property records, and one copy will be sent immediately to the corps area finance officer for the auditor's file.

HARRY A. KEEP
Capt. Sig. Corps

Approved for publication and
distribution in Air Service
Command

This Page Intentionally Blank

